

# **OPERATION MANUAL**

## **COMMUNICATIONS SERVICE MONITOR**

### **IFR-1900**

PUBLISHED BY  
IFR AMERICAS, INC.

COPYRIGHT © IFR Americas, Inc. 1997

All rights reserved. No part of this publication may be reproduced, stored in a retrieval system, or transmitted in any form or by any means, electronic, mechanical, photocopying, recording or otherwise without the prior permission of the publisher.

NT400 is COPYRIGHTED © by Northern Telecom, Inc.

10200 West York / Wichita, Kansas 67215 U.S.A. / (316) 522-4981 / FAX (316) 524-2623

## **SAFETY FIRST: TO ALL OPERATIONS PERSONNEL**

**REFER ALL SERVICING OF UNIT TO QUALIFIED TECHNICAL PERSONNEL. THIS UNIT CONTAINS NO OPERATOR SERVICEABLE PARTS.**

### **CASE, COVER OR PANEL REMOVAL**

Removing the Test Set from the case exposes the operator to electrical hazards that can result in electrical shock or equipment damage. Do not operate this Test Set with the Chassis Assembly removed from the Case Assembly.

### **SAFETY IDENTIFICATION IN TECHNICAL MANUAL**

This manual uses the following terms to draw attention to possible safety hazards, that may exist when operating this equipment.

**CAUTION:** THIS TERM IDENTIFIES CONDITIONS OR ACTIVITIES THAT, IF IGNORED, CAN RESULT IN EQUIPMENT OR PROPERTY DAMAGE (E.G., FIRE).

**WARNING:** THIS TERM IDENTIFIES CONDITIONS OR ACTIVITIES THAT, IF IGNORED, CAN RESULT IN PERSONAL INJURY OR DEATH.

### **SAFETY SYMBOLS IN MANUALS AND ON UNITS**



CAUTION: Refer to accompanying documents.



AC OR DC TERMINAL: Terminal that may supply or be supplied with ac or dc voltage.



DC TERMINAL: Terminal that may supply or be supplied with dc voltage.



AC TERMINAL: Terminal that may supply or be supplied with ac or alternating voltage.



SWITCH ON/OFF (Push-Push): AC line power to the device is connected ON or disconnected OFF.

### **EQUIPMENT GROUNDING PRECAUTION**

Improper grounding of equipment can result in electrical shock.

### **USE OF PROBES**

Check the specifications for the maximum voltage, current and power ratings of any connector on the Test Set before connecting it with a probe from a terminal device. Be sure the terminal device performs within these specifications before using it for measurement, to prevent electrical shock or damage to the equipment.

### **POWER CORDS**

Power cords must not be frayed, broken nor expose bare wiring when operating this equipment.

### **USE RECOMMENDED FUSES ONLY**

Use only fuses specifically recommended for the equipment at the specified current and voltage ratings.

### **INTERNAL BATTERY**

This unit contains a Lithium Battery, serviceable only by a qualified technician.

**CAUTION:** SIGNAL GENERATORS CAN BE A SOURCE OF ELECTROMAGNETIC INTERFERENCE (EMI) TO COMMUNICATION RECEIVERS. SOME TRANSMITTED SIGNALS CAN CAUSE DISRUPTION AND INTERFERENCE TO COMMUNICATION SERVICES OUT TO A DISTANCE OF SEVERAL MILES. USERS OF THIS EQUIPMENT SHOULD SCRUTINIZE ANY OPERATION THAT RESULTS IN RADIATION OF A SIGNAL (DIRECTLY OR INDIRECTLY) AND SHOULD TAKE NECESSARY PRECAUTIONS TO AVOID POTENTIAL COMMUNICATION INTERFERENCE PROBLEMS.

# LIST OF EFFECTIVE PAGES

The manual pages listed below that are affected by a current change or revision, are so identified by a revision number.

**Date of Issue for original and changed pages are:**

Original ..... 0 ..... Aug. 1997

**TOTAL NUMBER OF PAGES IN THIS MANUAL IS 674 CONSISTING OF THE FOLLOWING**

Pg. No.	Rev. No.	Pg. No.	Rev. No.
Title\Copyright .....	0	3-153 through 3-227 .....	0
Title\Copyright Blank .....	0	3-228 Blank .....	0
Safety .....	0	4-1 through 4-97.....	0
Safety Blank .....	0	4-98 Blank .....	0
A .....	0	4-99 through 4-117 .....	0
B Blank .....	0	4-118 Blank .....	0
i through x .....	0	4-119 through 4-151 .....	0
1-1 through 1-19 .....	0	4-152 Blank .....	0
1-20 Blank .....	0	5-1 through 5-3 .....	0
2-1 through 2-2 .....	0	5-4 Blank.....	0
3-1 Blank.....	0	6-1 through 6-59.....	0
3-2 through 3-3 .....	0	6-60 Blank .....	0
3-4 Blank.....	0	7-1 through 7-29.....	0
3-5 through 3-13 .....	0	7-30 Blank .....	0
3-14 Blank .....	0	7-31 through 7-103 .....	0
3-15 through 3-39.....	0	7-104 Blank .....	0
3-40 Blank .....	0	A-1 through A-8 .....	0
3-41 through 3-65.....	0	B-1 through B-50 .....	0
3-66 Blank .....	0	C-1 through C-18.....	0
3-67 through 3-139.....	0	D-1 through D-3 .....	0
3-140 Blank .....	0	D-4 Blank.....	0
3-141 through 3-151 .....	0	E-1 through E-2.....	0
3-152 Blank .....	0	Index-1 through Index-6 .	0

# PREFACE

## SCOPE

This manual contains instructions for operating the IFR-1900 Communications Service Monitor. The instruction level is relatively basic and presupposes no previous experience on the part of the operator with a communication service monitor of this type. A basic understanding of communication electronics and practical troubleshooting methods is helpful. It is strongly recommended that the operator be thoroughly familiar with this manual before attempting to operate the unit.

## ORGANIZATION

The IFR-1900 Operation Manual is composed of the following sections:

### SECTION 1 - INTRODUCTION

Provides an introduction to the unit and a brief overview of unit functions. Specifications are also included in this section.

### SECTION 2 - INSTALLATION

Provides a step-by-step procedure for placing the IFR-1900 into operation.

### SECTION 3 - DESCRIPTION OF CONTROLS, CONNECTORS AND INDICATORS

Identifies and functionally describes all IFR-1900 controls, connectors and indicators. Additionally, all Operation Screens and Menus are identified and available parameters listed and explained.

**NOTE:** Figures 3-1 and 3-2, pictorial drawings of the Front and Rear Panels, locate and identify all IFR-1900 controls, connectors and indicators. The operator may utilize these drawings to reference any front or rear panel control while simultaneously performing any operating procedure contained elsewhere in the manual.

### SECTION 4 - OPERATION

Provides instructions for operating the IFR-1900 Mode Operating Screens and Menus. In addition, this section contains a selection of operating examples pertaining to each of the major functions of the Test Set.

### SECTION 5 - PERFORMANCE EVALUATION

Identifies and explains procedures the operator can use to reasonably ensure the IFR-1900 is performing properly.

### SECTION 6 - REMOTE OPERATION

Provides procedures for configuring and operating the IFR-1900 remotely. Lists unit specific commands for remote operations as well as commands mandated by IEEE 488.2 1987.

### SECTION 7 - CELLULAR AMPS/NAMPS

Identifies and provides instructions for operating the AMPS/NAMPS (non-TDMA) cellular Monitor and Simulation capabilities of the IFR-1900



## REFERENCE DOCUMENTATION

EIA/TIA-553	09/89	Mobile Station-Land Station Compatibility Specification <sup>1</sup>
IS-88	01/93	Mobile Station-Land Station Compatibility Standard for Dual-Mode Narrowband Analog Cellular Technology (TIA/EIA INTERIM STANDARD) <sup>2</sup>

<sup>1</sup>For AMPS equipment.

<sup>2</sup>For NAMPS equipment.

# TABLE OF CONTENTS

## SECTION 1 - INTRODUCTION

Paragraph	Title	Page
1-1	General .....	1-1
1-2	RF Generator .....	1-1
1-3	Receiver .....	1-2
1-4	Duplex .....	1-2
1-5	Audio Function Generators .....	1-2
1-6	Oscilloscope .....	1-2
1-7	Spectrum Analyzer .....	1-4
1-8	Meters .....	1-4
1-9	Data Entry and Display .....	1-4
1-10	Specifications (IFR-1900 with CSA Option) .....	1-5

## SECTION 2 - INSTALLATION

Paragraph	Title	Page
2-1	General .....	2-1
2-2	Precautions .....	2-1
2-3	Power Up Procedure .....	2-1

## SECTION 3 - DESCRIPTION OF CONTROLS, CONNECTORS AND INDICATORS

Paragraph	Title	Page
3-1	IFR-1900 Front Panel .....	3-5
3-2	IFR-1900 Rear Panel .....	3-11
3-3	Operation Screens and Menu Configurations .....	3-13
3-3-1	RF Generator Operation Screen .....	3-15
3-3-2	Receive Operation Screen .....	3-41
3-3-3	Duplex Operation Screen .....	3-67

Paragraph	Title	Page
3-3-4	Duplex Transmitter Operation Screen .....	3-73
3-3-5	Duplex Receiver Operation Screen .....	3-96
3-3-6	AF Generator Operation Screen .....	3-123
3-3-7	Oscilloscope Operation Screen .....	3-131
3-3-8	Spectrum Analyzer Operation Screen .....	3-141
3-3-9	Meter Operation Screens and Menus .....	3-153
3-3-10	Auxiliary Functions Menu .....	3-219

### **SECTION 4 - OPERATION**

Paragraph	Title	Page
4-1	General .....	4-1
4-1-1	Parameter Memory Operation .....	4-1
4-1-2	Printing Display Screens .....	4-4
4-2	RF Generator Operation .....	4-5
4-2-1	RF Generator General Operation .....	4-5
4-2-2	Generating FM Modulated RF Signal .....	4-21
4-2-3	Generating AM Modulated RF Signal .....	4-21
4-2-4	Externally Modulating RF Signal Generator .....	4-22
4-2-5	Generating DTMF Coded RF Signal .....	4-23
4-2-6	Generating Audio Two Tone Coding .....	4-24
4-2-7	Generating 5/6 Audio Tone .....	4-25
4-2-8	Generating DCS Code .....	4-26
4-2-9	Generating POCSAG Code .....	4-27
4-2-10	Generating 2805 Code .....	4-28
4-2-11	Generating Tone Remote Code .....	4-29
4-2-12	Measuring SINAD Sensitivity, Center Frequency and Modulation Acceptance Bandwidth .....	4-30

Paragraph	Title	Page
4-2-13	Measuring Receiver IF Bandwidth .....	4-32
4-3	Receiver Operation.....	4-33
4-3-1	Receiver General Operation .....	4-33
4-3-2	Receiving FM Signals .....	4-45
4-3-3	Receiving AM Signals .....	4-46
4-3-4	Decoding DTMF Coded Signals.....	4-47
4-3-5	Decoding Audio CCIR Coded Signals.....	4-48
4-3-6	Decoding Audio User Defined Coded Signals.....	4-49
4-3-7	Decoding DCS Coded Signals .....	4-51
4-3-8	Decoding POCSAG Coded Signals .....	4-52
4-3-9	Measuring AM or FM Transmitter Distortion.....	4-53
4-4	Duplex Operation .....	4-55
4-4-1	Duplex General Operation .....	4-55
4-4-2	Measuring Linear Amplifier Gain, Compression and Bandwidth.....	4-68
4-4-3	Measuring Mixer Performance.....	4-69
4-4-4	Duplex Transmitter Operation .....	4-71
4-4-5	Duplex Receiver Operation.....	4-82
4-5	AF Generator Operation .....	4-99
4-5-1	AF Generator General Operation.....	4-99
4-5-2	Generating Tone Remote Code .....	4-104
4-5-3	Generating AF Tone .....	4-104
4-6	Oscilloscope Operation .....	4-105
4-7	Spectrum Analyzer Operation .....	4-109
4-7-1	Spectrum Analyzer General Operation .....	4-109

Paragraph	Title	Page
4-7-2	Measuring Very Low Power Transmitter Output .....	4-114
4-7-3	Measuring Transmitter Harmonics .....	4-115
4-7-4	Measuring Diplexer TX Loss and RX Isolation .....	4-116
4-8	Meter Operation .....	4-119
4-8-1	Audio Frequency Meter Operation .....	4-119
4-8-2	RF Frequency Error Meter Operation.....	4-121
4-8-3	Power Meter Operation .....	4-123
4-8-4	Deviation Meter (Peak) Operation .....	4-126
4-8-5	Modulation Meter Operation .....	4-128
4-8-6	Distortion Meter Operation .....	4-130
4-8-7	SINAD Meter Operation.....	4-132
4-8-8	Signal Strength Meter Operation .....	4-134
4-8-9	Bit Error Rate (BER) Meter Operation.....	4-136
4-8-10	Digital Multimeter Operation .....	4-142
4-8-11	Phase Meter Operation .....	4-145
4-8-12	Deviation Meter (RMS) Operation.....	4-147
4-8-13	Phase Meter (RMS) Operation .....	4-149
4-8-14	Audio Frequency Level Meter (RMS) Operation .....	4-151

## **SECTION 5 - PERFORMANCE EVALUATION**

Paragraph	Title	Page
5-1	General.....	5-1
5-2	Power-Up Self Test .....	5-1
5-3	Self Test .....	5-1

## SECTION 6 - REMOTE OPERATION

Paragraph	Title	Page
6-1	General.....	6-1
6-2	Remote Operating Procedures .....	6-1
6-2-1	Remote Operation Using Host System (RS-232) .....	6-2
6-2-2	Remote Operation Using Modem (RS-232) .....	6-3
6-2-3	Operating IFR-1900 as RS-232 Terminal.....	6-4
6-2-4	Remote Operation Using GPIB.....	6-5
6-3	TMAC (Test Macro Language).....	6-6
6-4	Command Syntax.....	6-7
6-5	Mandatory IEEE 488.2 Commands.....	6-8
6-6	IFR-1900 Specific Commands .....	6-9
6-7	Flash Memory File Directory Operation .....	6-56

## SECTION 7 - CELLULAR AMPS/NAMPS

Paragraph	Title	Page
7-1	AMPS/NAMPS Cell Site Monitor .....	7-1
7-1-1	AMPS/NAMPS Cell Site Monitor Setup.....	7-1
7-1-2	Forward Control Channel Screen.....	7-6
7-1-3	Forward Control Channel Setup Menu.....	7-10
7-1-4	Reverse Control Channel Screen .....	7-16
7-1-5	Forward Voice Channel Screen.....	7-19
7-1-6	Reverse Voice Channel Screen.....	7-25
7-2	AMPS/NAMPS Cellular Simulation .....	7-31
7-2-1	Forward Control Channel Cell Site Simulation Screen .....	7-35
7-2-2	Reverse Control Channel Mobile Simulation Screen .....	7-54
7-2-3	Forward Voice Channel Cell Site Simulation Screen.....	7-60

Paragraph	Title	Page
7-2-4	Reverse Voice Channel Mobile Simulation Screen .....	7-67
7-2-5	Cellular Simulation Settings .....	7-73
7-3	AMPS/NAMPS Remote Operation.....	7-75

## APPENDICES

Appendix	Title	Page
Appendix A	User I/O Connectors and Pin-Out Tables .....	A-1
Appendix B	NADC/NAMPS Cellular Telephone Channel Numbers and Center Frequencies.....	B-1
Appendix C	TACS/E-TACS Cellular Telephone Channel Numbers and Center Frequencies.....	C-1
Appendix D	Abbreviations.....	D-1
Appendix E	Repacking For Shipping .....	E-1

## INDEX

Index	Index-1
-------	---------

## LIST OF ILLUSTRATIONS

Figure No.	Title	Page
1-1	Examples of Duplex Testing .....	1-3
2-1	Rear Panel Power Up Controls, Connectors and Indicators .....	2-1
2-2	Front Panel Power Up Controls, Connectors and Indicators .....	2-2
3-1	IFR-1900 Front Panel Controls, Connectors and Indicators .....	3-2
3-2	IFR-1900 Rear Panel Controls, Connectors and Indicators.....	3-2
3-3	RF Frequency / Cellular Channel Display Area .....	3-18
4-1	Cable Fault Horizontal Marker Setting .....	4-115
5-1	Self Test Menu .....	5-1
5-2	Test Running Counter .....	5-1
5-3	"All Tests" Failure .....	5-2
5-4	"All Tests" Pass.....	5-2
5-5	Individual Test Failure .....	5-2
7-1	AMPS/NAMPS Cell Site Monitor Hierarchy .....	7-2
7-2	AMPS/NAMPS Cellular Simulation Screen Hierarchy .....	7-33
A-1	MIC/ACC Connector Pin Identification .....	A-3
A-2	SCSI Connector Pin Identification .....	A-4
A-3	GPIB Connector Pin Identification .....	A-5
A-4	HOST RS-232 Connector Pin Identification .....	A-6
A-5	EXTERNAL VIDEO Connector Pin Identification.....	A-7
A-6	Printer Connector Pin Identification .....	A-8
E-1	Repacking for Shipment .....	E-2



## LIST OF TABLES

Table No.	Title	Page
3-1	"SHIFT" Characters .....	3-7
3-2	Receiver Modulation Type Parameters.....	3-43
3-3	User Defined AGC Type Parameters.....	3-62
3-4	External Loss/Gain .....	3-165
4-1	dBm, W and dBW Conversions.....	4-116
6-1	Rear Panel I/O Connectors By Section .....	6-1
6-2	Terminal Settings for RS-232 Host Operation .....	6-2
6-3	Command Syntax Punctuation Marks .....	6-8
6-4	Mandatory GPIB Commands .....	6-8
6-5	IFR-1900 Specific Commands .....	6-9
6-6	Flash Memory Remote Commands.....	6-57
6-7	Flash Memory Error Messages.....	6-59
7-1	IFR-1900 Specific Cellular Commands.....	7-75
A-1	Table of I/O Connectors .....	A-1
A-2	Pin-Out for MIC/ACC Connector.....	A-3
A-3	Pin-Out for SCSI Connector.....	A-4
A-4	Pin-Out for GPIB Connector .....	A-5
A-5	Pin-Out for HOST RS-232 Connector.....	A-6
A-6	Pin-Out for EXTERNAL VIDEO Connector .....	A-7
A-7	Pin-Out for Printer Connector .....	A-8
B-1	NADC/NAMPS Cellular Channel Numbers and Frequencies.....	B-1
C-1	TACS/E-TACS Cellular Channel Numbers and Frequencies .....	C-1

# SECTION 1 - INTRODUCTION

## 1-1 GENERAL

The IFR-1900 is a microprocessor controlled, digitally synthesized communications service monitor that combines the operation of many different test instruments into a single, compact unit. The IFR-1900, operating primarily within the 400 MHz, 800 MHz and 1900 MHz cellular and PCS bands, also includes a Spectrum Analyzer covering the bandwidth of 10 MHz to 2010 MHz.

Functions the IFR-1900 is capable of performing include:

- RF Generator
- Duplex
- Spectrum Analyzer
- DMM
- Distortion Meter
- Audio Frequency Meter
- RF Power Meter
- Signal Strength Meter
- Phase Meters
- AF Level (RMS) Meter
- Tracking Generator
- AMPS<sup>1</sup>/NAMPS Analog Cellular Monitoring and Simulation
- Receiver
- AF Generator
- Oscilloscope
- Deviation (Peak) Meter
- SINAD Meter
- Frequency Error Meter
- Modulation Meter
- Bit Error Rate Meter
- Deviation (RMS) Meter
- Cable Fault Detector
- Digital Radio Paging Encode and Decode
- Analog Radio Paging Encode and Decode

The IFR-1900 utilizes an alphanumeric keypad, dedicated function keys, multitask Soft Function Keys and a high-resolution color display to show, enter and edit functions and data. Testing with this instrument can be done remotely or manually. The IFR-1900 can perform tests from pre-programmed setups or formats determined at the time of the test. Microprocessor controlled memory allows storage and recall of parameters for each of the testing modes as well as storage and recall of Oscilloscope and Spectrum Analyzer traces for signal comparison.

## 1-2 RF GENERATOR

The IFR-1900 is capable of generating modulated or unmodulated carrier signals from 10 to 2010 MHz. The RF Generator is designed to provide coverage for the 400, 800 and 1900 MHz bands. Modulation types include AM, FM and PM. Modulation can also be applied from an external source. The RF Generator also functions as a tracking generator for swept measurements or as an offset generator in Duplex Mode. Metering functions available for this operation mode include SINAD, DMM, Distortion and Audio Frequency Level meters. The Oscilloscope and Spectrum Analyzer are also available for use on the RF Generator Operation Screen.

1. AMPS protocol is used; however, frequencies are extended to include all of North American Digital Cellular (NADC) frequencies. NADC frequencies consist of the following: 800 MHz (AMPS), 450 MHz (NT400©) and 1900 MHz (Hyperband).

### **1-3 RECEIVER**

The IFR-1900 is capable of receiving modulated and unmodulated signals from 10 to 2010 MHz. The Receiver is designed to provide coverage for the 400, 800 and 1900 MHz bands. The IFR-1900 receives AM, FM and PM modulated signals. Metering functions in the IFR-1900 available with the Receiver include RF Power, Modulation, Deviation, Distortion, Frequency Error, AF Frequency, Signal Strength and SINAD meters and counters. The Oscilloscope and Spectrum Analyzer are also available for use on the Receiver Operation Screen. The IFR-1900 Receiver is capable of executing user defined frequency scan operations as well as single frequency operations. The Receiver accesses "off the air" signals through the ANTENNA IN Connector or higher powered signals are accessed through the T/R Connector.

### **1-4 DUPLEX**

The IFR-1900 features Duplex Operation from 10 to 2010 MHz. The Duplex Operation of the IFR-1900 is designed to provide coverage for the 400, 800 and 1900 MHz bands. The operator has the option of monitoring the transmitter, receiver or both with the color display. All features available with the RF Generator and Receiver are available in Duplex as well as the ability to use an offset frequency to test communication equipment capable of generating and receiving simultaneously on different frequencies. While in the Duplex mode, the IFR-1900 utilizes the RF Generator and Receiver as in their individual modes, but features separate screen settings. See Figure 1-1 for examples of Duplex testing.

**NOTE:** Simplex testing may be performed with the IFR-1900 in RF Generator mode. With the RF Generator and Receiver correctly configured and the RF Generator Operation screen displayed, the IFR-1900 automatically switches to the Receiver Operation screen when a signal greater than 100 mW is applied to the T/R Connector. The IFR-1900 returns to the RF Generator Operation screen when the applied signal drops below the threshold.

### **1-5 AUDIO FUNCTION GENERATORS**

Two Audio Function Generators are included in the IFR-1900 with a range of 10 Hz to 40 kHz. Signals generated are transmitted as generated or modulated before transmission. Available waveforms include sine, square, triangle, ramp and pulse. The IFR-1900 is also capable of creating digital data bit patterns.

### **1-6 OSCILLOSCOPE**

The IFR-1900 includes a 1 MHz single trace Oscilloscope as one of its major test functions. The Oscilloscope allows input from 1 mV to 50 V with a maximum input voltage of 200 V<sub>peak</sub>. Sweep rates range from 1  $\mu$ s to 100 ms/div. The IFR-1900 Oscilloscope has a store and recall ability of up to nine signals. The recalled trace is shown simultaneously with a live trace, giving the operator the opportunity to compare the two traces. Signals available for use include AC, DC, GND, Receiver IF, Demodulated Audio, Function Generators, External Audio, SINAD/BER and RF Power. The Oscilloscope is available for view alone or in all major Operation Modes except where Duplex Transmitter and Receiver are shown simultaneously. Size options for view in other modes are full-size and 1/4-size.

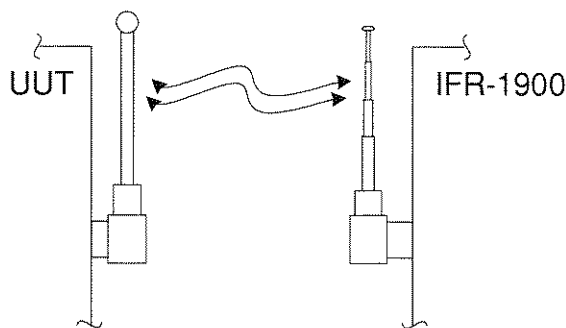
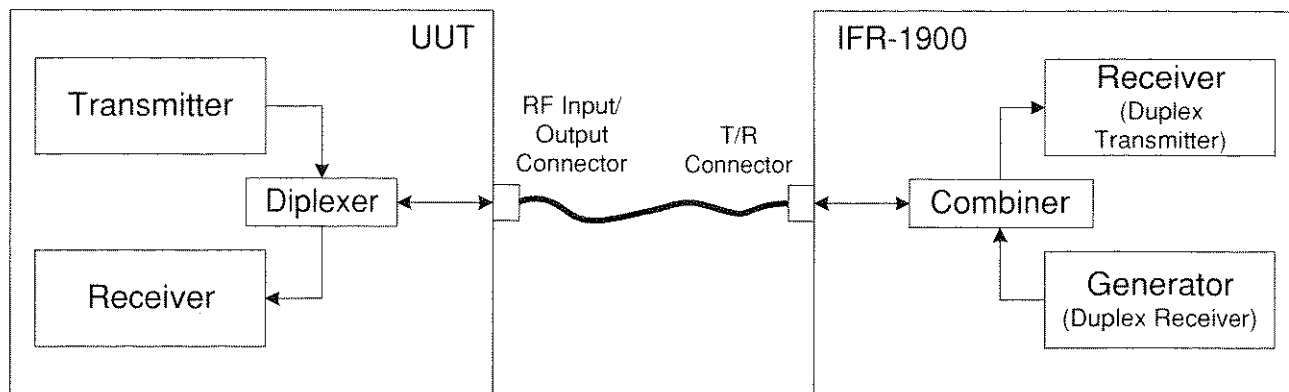

**NOTE:** This operation requires a frequency offset between the transmitted and received signals of the UUT.

*Example of Duplex Operation using T/R Connector*

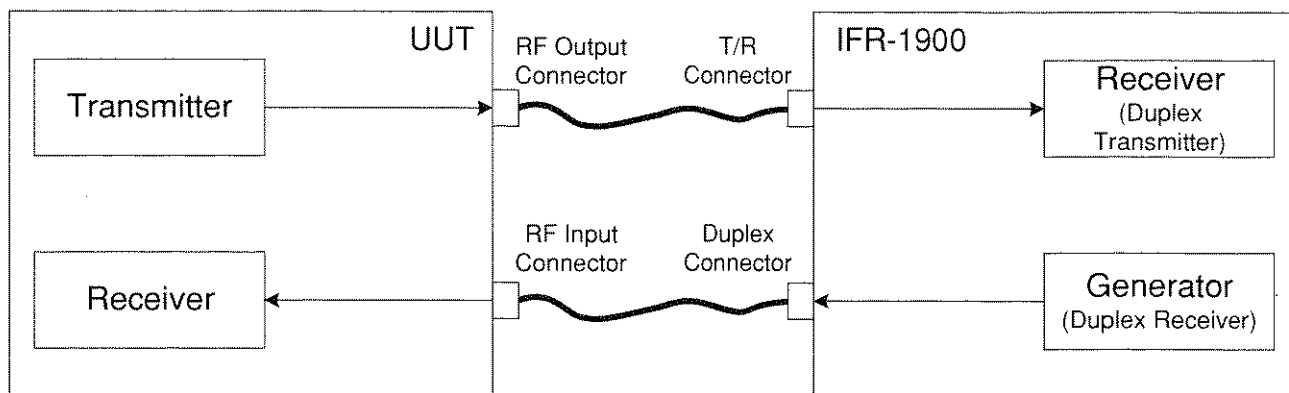

**NOTE:** This operation does not require a frequency offset between the transmitted and received signals of the UUT.

*Example of Duplex Operation using Duplex and T/R Connectors*

03403010

Figure 1-1 Examples of Duplex Testing

## **1-7 SPECTRUM ANALYZER**

The Spectrum Analyzer monitors internal and external signals from 10 to 2010 MHz. Scan widths range from 1 kHz to 100 MHz as well as zero scan. Available log scales are 2 and 10 dB/div with amplitude scale units of dBm, dB $\mu$ V, dBmV, dBV, dB $\mu$ W and dBW. Memory functions for the Spectrum Analyzer include store and recall of a trace, compare a stored trace to a live trace and peak hold. External signals can be "off the air" through the ANTENNA IN Connector or applied through the T/R Connector. The Spectrum Analyzer has variable attenuation through both connectors. The Spectrum Analyzer also has a tracking generator function with a variable level. The Spectrum Analyzer is available for display alone or in all major operation modes except where the Duplex Transmit and Receive functions are shown simultaneously. Size options for view in other modes are full-size and 1/4-size.

## **1-8 METERS**

The IFR-1900 provides the meters listed in 1-1 for use as independent test functions as well as synthesizing several into the major mode functions. As independent functions, the meters provide a bar graph display and digital data. On the major operations screens, these meters display as bar graph display and digital data or just as digital data, depending on the Oscilloscope/Spectrum Analyzer display size. The meters are used to monitor both internal and external input.

## **1-9 DATA ENTRY AND DISPLAY**

Unless the IFR-1900 is configured for remote testing, all data received by the operator is in the form of screens and menus. Each major test operation has a dedicated operation screen with subordinate setup menus. Operation screens reflect changes in parameters imposed by the operator or changes in data delivered by the Unit Under Test (UUT). Individual meters also have dedicated operation screens and subordinate setup menus. The Meter Operation Screens can be accessed through the mode operation screen that is being supported by that specific Meter Operation or through the Meter Menu. Refer to 3-3-9 for a description of the different meters.

On selecting a specific mode of operation, the operation screen appears on the color display. The parameters shown reflect the parameters last entered in that operation. This specific operation screen is accessed with one of six dedicated MODE Keys. Setup menus on all mode operation screens are accessed from the specific operation screen by pressing the SETUP Key. Operator entry and the editing of data is performed within the operation screen or setup menu. The operation screen and menu have active cursors which the operator can use to access a specific parameter. Once the parameter is accessed, data can be selected with DATA SCROLL Spinner or DATA SCROLL Keys or by using the alphanumeric DATA ENTRY Keypad. Multitask "Soft" Function Keys are also available to perform setup, edit and entry. Each operation screen defines Soft Function Keys to fit the specific needs for that operation. These definitions are displayed on the screen above the defined key. Each operation screen may have several definitions for each Soft Function Key or make a definition unavailable depending on the parameters of the operation. Various functions performed by these multitask keys include toggling between two values, selecting connectors for access, entering data or selecting a field to be edited.

## 1-10 SPECIFICATIONS (IFR-1900 WITH CSA OPTION)

Unless otherwise stated, the following conditions shall apply:

- Where specified resolution exceeds specified accuracy, specified resolution takes precedence.
- Accuracy and Resolution stated in percentage are reference to a measured or selected value.
- All RF characteristics are referenced to 50  $\Omega$ .
- 15 minute warm-up.

### **RF SIGNAL GENERATOR**

#### **★ RF SIGNAL GENERATOR (T/R CONNECTOR)**

##### **Frequency**

Range	10 to 2010 MHz
Resolution	100 Hz
Accuracy	Same as Master Oscillator

##### **Level**

Range	-127 to -10 dBm, -30 dBm Max with Reverse Power Present	
Resolution	0.1 dB	
Accuracy	(RF >400 MHz)	±1.5 dB, -110 to -10 dBm; ±2.0 dB, -119 to -110 dBm; ±3.0 dB, -127 to -119 dBm
	(RF <400 MHz)	±3.0 dB, -110 to -10 dBm; ±3.5 dB, -119 to -110 dBm; ±4.0 dB, -127 to -119 dBm

**Output Impedance**                      50  $\Omega$  (See **RF Power Meter** for T/R Connector Return Loss spec.)

## Spectral Purity

Residual FM	<50 Hz RMS for <1000 MHz; <70 Hz RMS for $\geq 1000$ MHz  (Post Detection bandwidth = 50 Hz to 15 kHz)
SSB Phase Noise	(RF <500 MHz) <-92 dBc/Hz at 20 kHz from carrier; (RF <1000 MHz) <-90 dBc/Hz at 20 kHz from carrier; (RF <2000 MHz) <-88 dBc/Hz at 20 kHz from carrier
Harmonics	<-26 dBc at -10 dBm output
Non-Harmonics	<-50 dBc at -10 dBm output ( $\pm 50$ MHz of selected frequency)
Residual AM	<0.1% RMS for <1010 MHz; <0.3% RMS for >1010 MHz  (Post Detection bandwidth = 50 Hz to 15 kHz)

● **RF SIGNAL GENERATOR (DUPLEX OUT CONNECTOR)**

**Frequency (Independent of Receiver Frequency Setting)**

Range	10 to 2010 MHz
Resolution	100 Hz
Accuracy	Same as Master Oscillator

**Level**

Range	-110 to -5 dBm, +10 dBm	Selectable from -120.0 to 10.0 dBm
Resolution	0.1 dB	
Accuracy	(RF >400 MHz)	±1.5 dB, -95 to -5 dBm; ±2.0 dB, -102 to -95 dBm; ±3.0 dB, -110 to -102 dBm
	(RF <400 MHz)	±3.0 dB, -95 to -5 dBm; ±3.5 dB, -102 to -95 dBm; ±4.0 dB, -110 to -102 dBm
		Level ±3.0 dB

**Output Impedance** 50 Ω Nominal

**Input Protection** Alarm sounds when power exceeds threshold.

**Spectral Purity**

Residual FM	<50 Hz RMS for <1000 MHz; <70 Hz RMS for ≥1000 MHz  (Post Detection bandwidth = 50 Hz to 15 kHz)
SSB Phase Noise	(RF <500 MHz) <-92 dBc/Hz at 20 kHz from carrier; (RF <1000 MHz) <-90 dBc/Hz at 20 kHz from carrier; (RF <2000 MHz) <-88 dBc/Hz at 20 kHz from carrier
Harmonics	<-26 dBc at -10 dBm output
Non-Harmonics	<-50 dBc at -10 dBm output (±50 MHz of selected frequency)
Residual AM	<0.1% RMS for <1010 MHz; <0.3% RMS for >1010 MHz  (Post Detection bandwidth = 50 Hz to 15 kHz)



● **RF SIGNAL MODULATION (T/R AND DUPLEX OUT CONNECTORS)**

**Internal Frequency Modulation (FM)**

RF Range	50 to 500 MHz; 800 to 900 MHz; 1750 to 2010 MHz	Will tune from 10 to 2010 MHz
Deviation Range	Off, $\pm 100$ Hz to $\pm 100$ kHz	
Deviation Resolution	100 Hz	
Audio Rate	Off, 1 to 10 kHz	
Accuracy	(1 through 20 kHz deviation) $\pm 5\%$ , $\pm$ residual, $\pm$ LSD (at 1 kHz rate); ( $>20$ kHz deviation) $\pm 10\%$ , $\pm$ residual, $\pm$ LSD	
Max. Sine Total Harmonic Distortion (THD)	1.0% at 100 Hz to 10 kHz rate; 2.0% at 10 kHz to 20 kHz rate  (6 kHz deviation)	

**Internal In-phase / Quadrature Modulation (IQ)**

RF Range	50 to 500 MHz; 800 to 900 MHz; 1750 to 2010 MHz	Will tune from 10 to 2010 MHz
IQ Error Vector Magnitude	Base Station: 6% from ideal DQPSK waveform (IS-136); Mobile Station: 8% from ideal DQPSK waveform (IS-136)	
IQ Origin Offset	$< -30$ dBc	

**External Modulation Sources**

External inputs with the same characteristics as internal sources are supported.

10 Vp-p injection level required to obtain indicated setting  $\pm 10\%$ .

## BASEBAND SIGNAL GENERATORS, AF GENERATORS #1 AND #2

### Frequency

Range	10 Hz to 40 kHz
Resolution	0.1 Hz (frequency $\leq 2$ kHz)
Accuracy	$\pm 0.1\%$

### Level

Range	1 mV to 3 VRMS (600 $\Omega$ )	
Resolution	0.1 mV (level $\leq 200$ mV); 0.7 mV (level $> 200$ mV)	
Accuracy	$\pm 3\%$ , $\pm$ LSD (freq $\leq 10$ kHz); $\pm 5\%$ , $\pm$ LSD (10 kHz $<$ freq $< 25$ kHz)	(600 $\Omega$ load)

### Spectral Purity

Sine Wave Total Harmonic Distortion (THD)	$< 1\%$ (1 kHz, 100 mVRMS)
---	----------------------------

### Waveshapes

Sine, Square, Triangle, Ramp, Pulse

## AUDIO FREQUENCY COUNTER

Range	10 Hz to 200 kHz (In 4 decade ranges)
Resolution	0.1 Hz ( $f_{input} \leq 2$ kHz); 1 Hz ( $2$ kHz $<$ $f_{input} \leq 20$ kHz); 10 Hz ( $f_{input} > 2$ kHz)
Accuracy	Same as Master Oscillator $\pm$ LSD
Input Level	
External Mod. Input	0.1 mV to 3.5 VRMS
SINAD Input	0.5 to 15 VRMS
Input Impedance	
External Mod. Input	100 k $\Omega$ nominal
SINAD Input	1 M $\Omega$ nominal
Input Waveform	Sine or square

## RF POWER METER

RF Input Range	440 to 495 MHz; 825 to 895 MHz; 1850 to 1990 MHz	Functional from 10 to 2010 MHz
Input Level Range	0.05 mW to 50 W RMS (frequency ≤900 MHz); 0.05 mW to 50 W RMS (frequency >900 MHz)  (1-2-5 sequence, 4 decade)	
Resolution	1% minimum	
Accuracy	15% ±LSD (1 mW ≤input power <100 mW); 10% ±LSD (100 mW ≤input power <5 W); 6% ±LSD (5 W ≤input power <50 W)	20° to 30° C
T/R Connector Return Loss	<-23 dB (frequency ≤500 MHz); <-20 dB (frequency >500 MHz)	

## RECEIVER

RF Range	440 to 495 MHz; 825 to 895 MHz; 1850 to 1990 MHz	Can tune from 10 to 2010 MHz	
Input Level Range			
T/R Connector	-30 to +47 dBm		
Antenna Connector	to 0 dBm		
Sensitivity	-80 dBm  (10 dB SINAD, 1 kHz rate, 6 kHz Deviation, FM2, Antenna input)		
Overload Protection	+15 dBm, ±7 dB alarm, >+15 dBm for 15 seconds max.		
Antenna Connector			
Selectivity			
	<b>Modulation Mode</b>	<b>IF Bandwidth</b>	<b>Audio Bandwidth</b>
	FM4	300 kHz	100 kHz
	FM3	300 kHz	20 kHz
	FM2	30 kHz	10 kHz
	FM1	30 kHz	3 kHz
	AM2	30 kHz	10 kHz
	AM1	2.9 kHz	3 kHz
	PM	30 kHz	3 kHz

Demod Output Impedance (nominal)	600 $\Omega$
Demod Output Level	
FM	5 Vp-p $\pm 15\%$ , full scale
PM	PM, 40 mVRMS $\pm 15\%$ , 5 radians
AM	1 VRMS $\pm 15\%$ , 80% modulation

### **RADIO FREQUENCY METER**

Input Frequency Range	100 to 2010 MHz	Can tune from 10 to 2010 MHz
Minimum RF Level (Antenna Input)	-60 dBm	
Resolution	1 Hz (RF $\leq 20$ MHz); 10 Hz (RF $> 20$ MHz)	
Accuracy	Master Oscillator $\pm$ LSD	

### **RADIO FREQUENCY ERROR METER**

Input Frequency Range	100 to 2010 MHz	Can tune from 10 to 2010 MHz
Counter Range	0 to $\pm 150$ kHz, or IF Bandwidth limit	
Meter Range	0 to $\pm 100$ kHz, in 4 decade ranges	
Minimum RF Level (Antenna Input)	-60 dBm	
Resolution	1 Hz (Reading 1 Hz to 10 kHz); 10 Hz (Reading $> 10$ kHz)	
Accuracy	Master Oscillator $\pm$ LSD	

### **FM DEVIATION METER**

Input Frequency Range	100 to 2010 MHz	Can tune from 10 to 2010 MHz
Minimum RF Level		
Antenna Input	-60 dBm	
T/R Input	0 dBm	
Deviation Frequency Range	$\pm 100$ Hz to $\pm 100$ kHz	
Resolution	100 Hz (meter range $\leq 20$ kHz); 1 kHz (meter range $> 20$ kHz)	
Accuracy	$\pm 5.0\%$ , $\pm 2$ LSD + source residual FM (FM4, rate $< 15$ kHz, 1 kHz $<$ deviation $< 20$ kHz)	

### AM MODULATION METER

Input Frequency Range	100 to 2010 MHz	Can tune from 10 to 2010 MHz
Minimum RF Level		
Antenna Input	-60 dBm	
T/R Input	0 dBm	
Modulation Range	1% to 90%	
Resolution	1%	
Accuracy	±5.0%, ±1 LSD + source residual AM (AM2, rate = 1 kHz, 30% <modulation <60%)	

### PM DEVIATION METER

Input Frequency Range	100 to 2010 MHz	
Minimum RF Level		
Antenna Input	-60 dBm	
T/R Input	0 dBm	
Modulation Range	0 to 10 Radians	
Resolution	0.01 Radian (deviation ≤5 Radians); 0.1 Radian (deviation >5 Radians)	

### DISTORTION METER

Meter Range	0% to 20%	
Input Level (SINAD/BER input)	0.1 to 10 VRMS	
Input Frequency Range	1 kHz	
Resolution	0.1%	
Accuracy	±0.5% distortion ±LSD (reading 1% to 10%); ±2.0% distortion ±LSD (reading >10%)	

## **ERROR VECTOR MAGNITUDE (EVM) METER**

Input Frequency Range	NT 400 channels Cellular channels PCS channels	Can tune from 10 to 2010 MHz
Minimum RF Level (Antenna Input)	-40 dBm	
EVM Range	0% to 100%	
EVM Resolution	0.01%	
Meter Residual EVM	<2% indication	
Accuracy	±3.0% indication, ±1 LSD + meter residual EVM	

## **SINAD METER**

Meter Range	3 to 30 dB
Input Level (SINAD / BER input)	0.1 to 10 VRMS
Input Frequency Range	1 kHz
Resolution	0.1 dB
Accuracy	±2 dB ±LSD

## DIGITAL MULTIMETER

### ● VOLTMETER (AC/DC)

Meter Ranges	200 mV, 2 V, 20 V, 200 V
Input Impedances	150 $\Omega$ $\pm$ 5%, 600 $\Omega$ $\pm$ 5%, 1 M $\Omega$ $\pm$ 10% (shunted by capacitance $\leq$ 150 pF)
Maximum Input Voltage for selected input impedance	150 $\Omega$ : 20 VRMS; 600 $\Omega$ : 30 VRMS; 1 M $\Omega$ : 30 VRMS
Input Frequency Range	DC and 50 Hz to 20 kHz
Resolution	3½ digits
Accuracy	(AC) $\pm$ 5%, full scale, $\pm$ 1 LSD (when applied volts times kHz product <140) (DC) $\pm$ 1%, full scale, $\pm$ LSD

### ● CURRENT METER (AC/DC)

Meter Ranges	20 mA, 200 mA, 2 A
Input Frequency Range	DC, 50 through 400 Hz
Resolution	3½ digits
Accuracy	$\pm$ 5%, full scale, $\pm$ 1 LSD or 0.1 mA, whichever is greater

### ● OHMMETER

Meter Ranges	200 $\Omega$ , 2 k $\Omega$ , 20 k $\Omega$ , 200 k $\Omega$ , 2 M $\Omega$ , 20 M $\Omega$
Resolution	3½ digits
Accuracy	$\pm$ 5%, full scale, $\pm$ 1 LSD or 0.1 $\Omega$ , whichever is greater

## OSCILLOSCOPE

**Vertical Bandwidth** 1 MHz at -3 dB

### Input

Ranges	1 mV/div to 50 V/div in 1-2-5 sequence, 8 divisions
Maximum Input Voltage	30 VRMS
Coupling	AC, DC, GND
Resolution	Full Scale/256
Accuracy	±5% of Full Scale
Accuracy (2 mV/div)	±10% of Full Scale

### Horizontal Sweep

Ranges	1 to 100 ms/div in 1-2-5 sequence, 10 divisions
Resolution	Full Scale/400
Accuracy	±1% of Full Scale

### External Input

Input Impedance	1 M $\Omega$
-----------------	--------------

## SPECTRUM ANALYZER

### Center Frequency

Range	50 through 2010 MHz	Can tune from 10 to 2010 MHz
-------	---------------------	------------------------------

### Frequency Span

Ranges	Zero scan, 1 kHz/div to 200 MHz/div in 1-2-5 sequence
Accuracy	±5% of Span Width

### Vertical

Scales	log 10 dB/div, log 2 dB/div
Resolution	Full Scale/256



## Amplitude

### Selectable Attenuation

(Antenna input) LNA\* and 0 to 30 dB in 5 dB steps  
(T/R input) ( $P \leq 2$  W) 40 to 70 dB in 5 dB steps;  
( $P > 2$  W) 60 to 90 dB in 5 dB steps

Dynamic Range 60 dB  
(0 dB attenuation, span < 1 MHz/div)

Accuracy  $\pm 4$  dB (50 to 400 MHz, Normalized);  
 $\pm 5$  dB (400 MHz to 1 GHz, Normalized);  
 $\pm 5$  dB (1 to 2 GHz, Normalized)

Bandwidth Switching Error <2 dB (5 kHz/div through 1 MHz/div);  
<3 dB (<5 kHz/div or >1 MHz/div)

\* Low Noise Amplifier. The same attenuation as 0 dB, but with a lower noise figure.  
(LNA is the preferred option for doing off-the-air applications.)

## BIT ERROR RATE (BER) METER

Range	$1 \times 10^{-1}$ to $1 \times 10^{-5}$
Data Rates	75, 150, 300, 600, 1200, 2400, 4800 bps and 16 kbps
Data Patterns	Random, Fixed, User Definable
Pattern Length	100 to 100,000 bits

## MASTER OSCILLATOR

### Oven Oscillator

Frequency	10 MHz nominal
Temperature Stability	$\pm 0.1$ ppm ( $0^\circ$ to $50^\circ$ C)
Aging	$\pm 0.1$ ppm per year; $\pm 0.001$ ppm per day
Final Calibration Accuracy	$\pm 0.1$ ppm

**NOTE:** Absolute frequency accuracy is affected by calibration accuracy, length of time since last calibration, aging rate, environmental conditions and exposure of unit to high mechanical or temperature stress.

## GENERAL CHARACTERISTICS

**Dimensions** 7.4" H x 18.8" W x 25" D (with bail handle and front panel cover in place)

**Weight** <48 lbs

### Display

Type	Color, Active Matrix LCD
Resolution	640 x 480 pixels

## REAR PANEL I/O

### ● RS-232C

**HOST Connector** (Connected to primary system control processor)

Operation Modes	Off, Host (PC Interface - Input/Output)
Baud Rates	300, 600, 1200, 2400, 4800, 9600, 19200, 38400
Parity	Odd, Even, Mark, Space, None
Data Bits	7 or 8
Stop Bits	1 or 2
Handshake	Xon/Xoff, Hardware, None

**OPT. Connector** (Connected to DMA system control processor)

Operation Modes	Always Operational (with CSA Option Installed)
Baud Rates	300, 600, 1200, 2400, 4800, 9600, 19200, 38400, 57600, 115200
Parity	Odd, Even, None
Data Bits	Same as HOST Connector.
Stop Bits	
Handshake (Pace)	

See IFR-1900 CSA Option Operation Manual

### ● IEEE-488

A 24-position connector and hardware interface in compliance with IEEE-488.1-1987. Functions in the set can be controlled through this interface. No manual intervention is required except for Power ON/OFF. The interface provides talker/listener modes for all the functions in this specification. The following are provided: SH1, AH1, T1, T2, TE0, L2, LE0, SR1, RL2, PP0, DC1, DT1, C0 or (C1, C2, C3, C4 user selectable).

Two IEEE-488 addresses are used internally.

- Internal Address #1 Connected to primary system control processor (default GPIB address = 4)
- Internal Address #2 Connected to TDMA system control processor (default GPIB address = 5)

● **SCSI**

Interface Connector (50 pin connector) for auxiliary box interface per ANSI X3.131-1986 standard. Two SCSI addresses are used internally.

● **EXTERNAL MONITOR (VGA)**

Video Graphics Array Interface (15 pin sub miniature D) for external monitor.

● **10 MHz FREQUENCY REFERENCE IN (BNC)**

Frequency	10 MHz nominal
Input Impedance	500 $\Omega$ nominal
input Level Range	1 to 5 Vp-p
Input Waveshape	Sine or Square

● **10 MHz FREQUENCY REFERENCE OUT (BNC)**

Frequency	
Input Impedance	Same as 10 MHz Frequency Reference IN
input Level Range	
Input Waveshape	

● **I AND Q OUTPUTS**

(CSA Option) BNC outputs (analog) representing the baseband drive signals for the DQPSK modulation for the 1900CSA generator.

● **SYNC OUT**

(CSA Option) BNC output (TTL) representing the beginning of the designated TDMA timeslot.

● **GEN IF OUT**

Future Use.

● **GEN IF IN**

Future Use.

● **REC IF OUT**

Future Use.

● **AUX I/O**

(CSA Option) Future Use.

● **PRINTER**

(CSA Option) Centronics-compatible printer interface connection (25-pin subminiature D connector).

## **POWER REQUIREMENTS**

Input Voltage Ranges	(60 Hz) 100 to 120 VAC (50 Hz) 220 to 240 VAC
Max. Input Power	210 W

## **TEMPERATURE REQUIREMENTS**

Operating	5° to 40° C
Storage (Non-operating)	-25° to 60° C

# SECTION 2 - INSTALLATION

## 2-1 GENERAL

This section contains information on preparing the IFR-1900 for use. Also listed are installation and operating precautions for safe use of the unit.

## 2-2 PRECAUTIONS

Before operating this instrument, the operator should be thoroughly familiar with all aspects of this manual.

For operator safety and to prevent damage to this instrument, the following operating precautions should be observed at all times:

**WARNING: THE IFR-1900 MUST BE CONNECTED TO ELECTRICAL GROUND. CONNECT THE FURNISHED AC POWER CORD TO A PROPERLY GROUNDED 3-PIN RECEPTACLE. DUE TO POTENTIAL SAFETY HAZARDS, USE OF THREE-PRONG TO TWO-PRONG ADAPTER PLUGS IS NOT RECOMMENDED.**

## 2-3 POWER UP PROCEDURE

The following procedure should be followed when applying power to the IFR-1900. Refer to Figures 2-1 and 2-2 for specific controls, connectors or indicators.

STEP	PROCEDURE
1.	Place IFR-1900 in horizontal operating position.
2.	If connected, remove ac power cord from receptacle.
3.	Determine operating voltage to be used.
4.	Remove each AC FUSE Housing on Rear Panel by rotating ccw to expose the ac fuses.

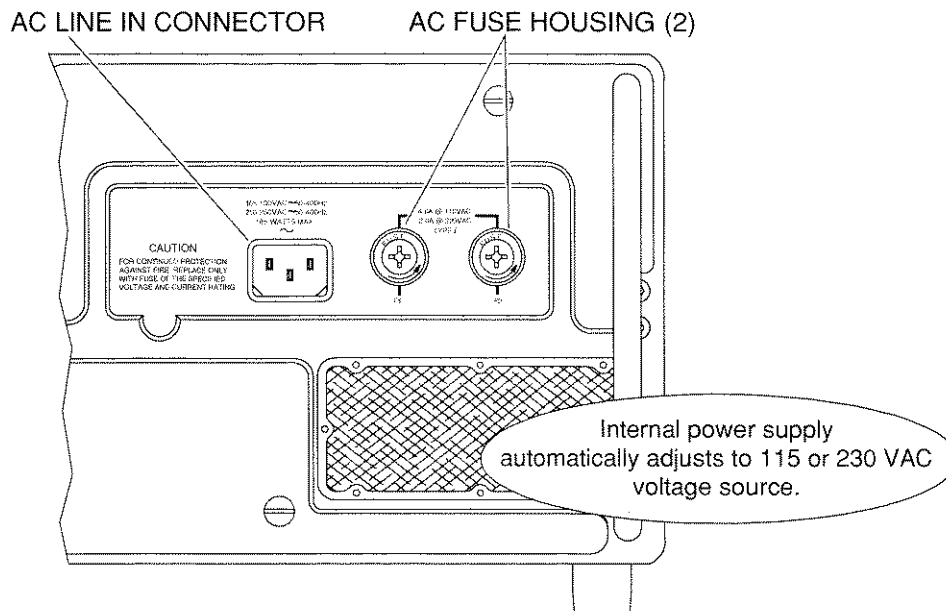

03420004

Figure 2-1 Rear Panel Power Up Controls, Connectors and Indicators

5. Ensure proper fuse (115 VAC operation requires 4.0 A fuse; 230 VAC operation requires 2.0 A fuse) is installed in both AC FUSE Housings. Internal power supply automatically adjusts to 115 or 230 VAC voltage source. 4.0 A fuses are provided for use with 115 VAC.

**CAUTION:** FOR SAFE OPERATION, REPLACE ONLY WITH FUSE OF SPECIFIED VOLTAGE AND CURRENT RATINGS.

6. Reinstall both AC FUSE Housings.
7. Connect power cord provided to AC LINE IN Connector (Figure 2-1). One ac power cord (U.S. only) is provided with unit. Be sure to inspect cord before using.

**WARNING:** A FRAYED OR BROKEN POWER CORD CAN RESULT IN FIRE OR ELECTRICAL SHOCK. DISCARD ALL DAMAGED POWER CORDS AND REPLACE WITH A POWER CORD FREE OF DEFORMITIES.

8. Plug cord into user provided power source. Ensure compatibility with voltage and grounding requirements for IFR-1900.
9. When power is connected to IFR-1900, POWER APPLIED Indicator lights.
10. Press IFR-1900 POWER Switch to ON Position.
11. POWER ON Indicator lights.

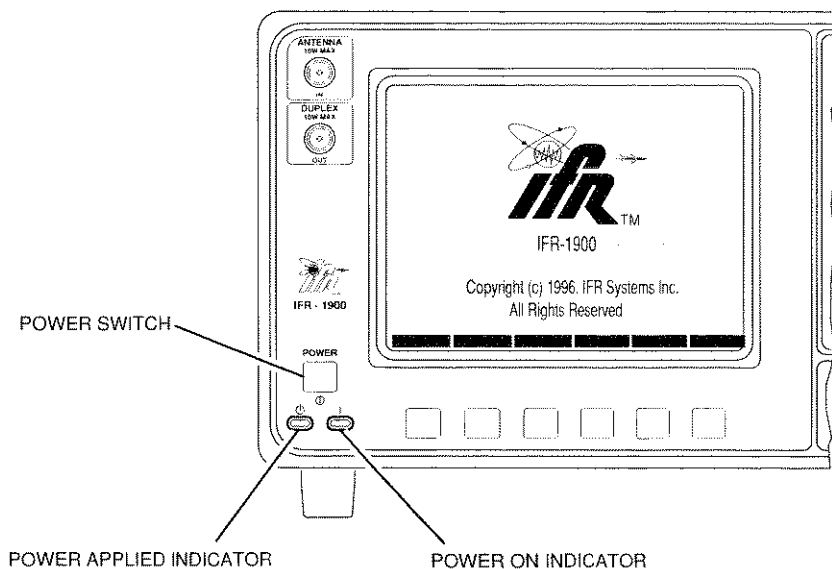

03420005

Figure 2-2 Front Panel Power Up Controls, Connectors and Indicators

# SECTION 3 - DESCRIPTION OF CONTROLS, CONNECTORS AND INDICATORS

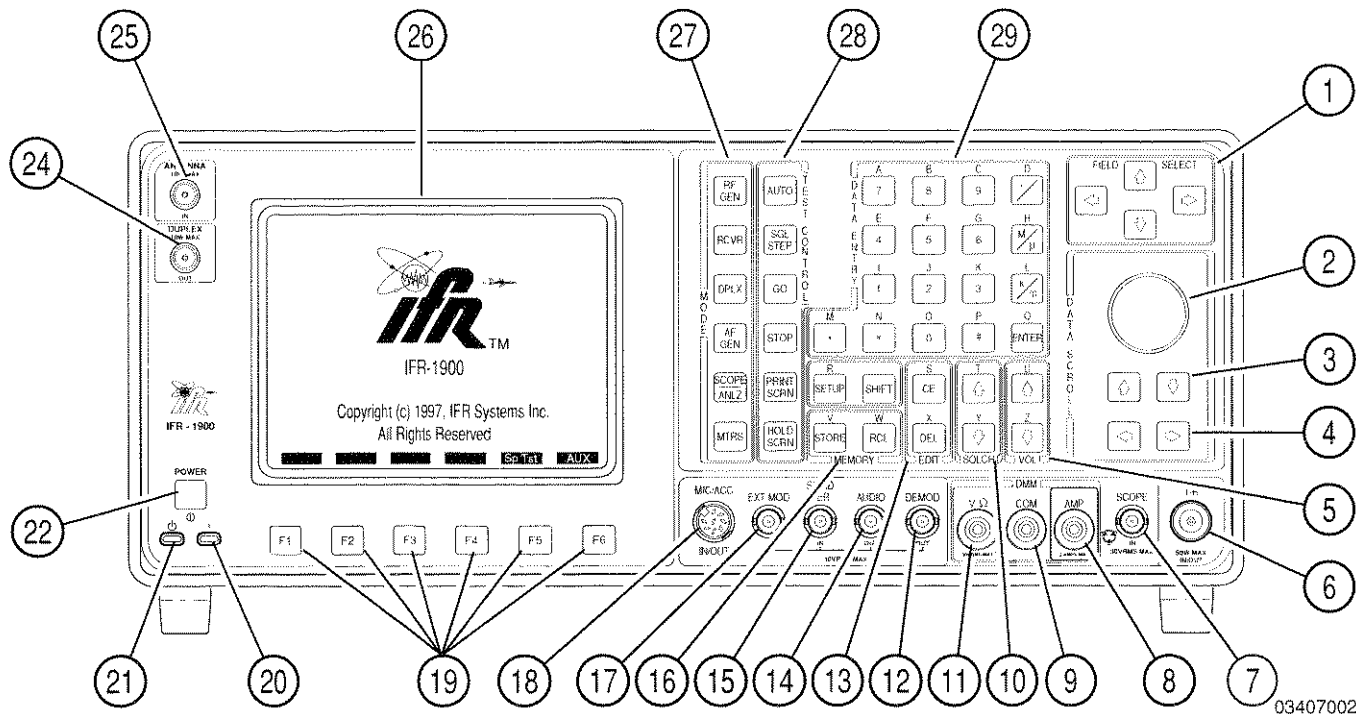

03407002

Figure 3-1 IFR-1900 Front Panel Controls, Connectors and Indicators

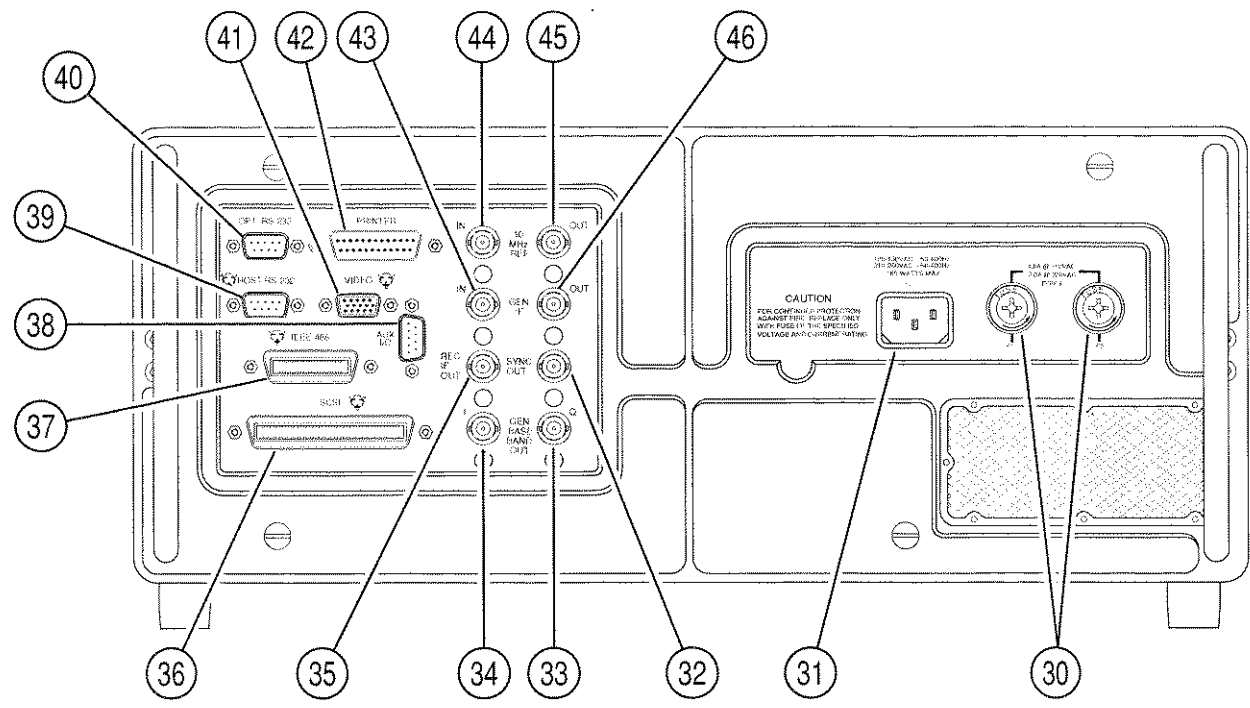

03407001



Figure 3-2 IFR-1900 Rear Panel Controls, Connectors and Indicators

- |                                      |  |
|--------------------------------------|--|
| 1. FIELD SELECT Keys                 | 25. ANTENNA IN Connector                             |
| 2. DATA SCROLL Spinner               | 26. COLOR DISPLAY                                    |
| 3. DATA SCROLL ↑ and ↓ Keys          | 27. MODE Keys  |
| 4. DATA SCROLL ← and → Keys          | 28. TEST CONTROL Keys                                |
| 5. VOL Keys                          | 29. DATA ENTRY Keypad                                |
| 6. T/R Connector                     | 30. AC FUSE Housing (2)                              |
| 7. SCOPE IN Connector                | 31. AC LINE IN Connector                             |
| 8. DMM AMP Connector                 | 32. SYNC OUT Connector                               |
| 9. DMM COM Connector                 | 33. GENERATOR BASEBAND OUT I Connector               |
| 10. SQLCH Keys                       | 34. GENERATOR BASEBAND OUT Q Connector               |
| 11. DMM V $\Omega$ Connector         | 35. RECEIVER IF Connector†                           |
| 12. DEMOD OUT Connector              | 36. SCSI (Small Computer System Interface) Connector |
| 13. EDIT Keys                        | 37. GPIB (IEEE-488) Connector                        |
| 14. AUDIO OUT Connector              | 38. AUXILIARY I/O Connector†                         |
| 15. SINAD/BER IN Connector           | 39. HOST RS-232 Connector                            |
| 16. MEMORY and SPECIAL FUNCTION Keys | 40. OPT. RS-232 Connector                            |
| 17. EXT MOD IN Connector             | 41. EXTERNAL VIDEO Connector                         |
| 18. MIC/ACC Connector                | 42. PRINTER Connector                                |
| 19. Soft Function Keys               | 43. GENERATOR IF IN Connector†                       |
| 20. POWER ON Indicator               | 44. 10 MHz REFERENCE IN Connector                    |
| 21. POWER APPLIED Indicator          | 45. 10 MHz REFERENCE OUT Connector                   |
| 22. POWER Switch                     | 46. GENERATOR IF OUT Connector†                      |
| 23. Reserved                         |  |
| 24. DUPLEX OUT Connector             |  |

† (Not Installed)



### 3-1 IFR-1900 FRONT PANEL

ITEM	DESCRIPTION
1. <u>FIELD SELECT Keys</u>	Up, down, left and right arrow keys are used to place the cursor in the desired data field on a menu or operation screen. FIELD SELECT Keys (←, ↑, →, ↓) move cursor to next data field in the indicated direction.
2. <u>DATA SCROLL Spinner</u>	Rapidly increases or decreases data within a selected field or chooses entries from lists.
3. <u>DATA SCROLL ↑ and ↓ Keys</u>	Steps data within a selected field. Data increases or decreases by a preset amount or next higher or lower data setting appears.
4. <u>DATA SCROLL ← and → Keys</u>	Moves data entry cursor to digit position. When a digit is selected and is incremented or decremented, the digit to the left increments or decrements as the selected digit passes "0."
5. <u>VOL Keys</u>	Increases (↑) or decreases (↓) speaker volume.
6. <u>T/R Connector</u> 	Connector for RF Generator Output and high power input. <b>CAUTION:</b> APPLY 50 W MAXIMUM.
7. <u>SCOPE IN Connector</u> 	Connector for signal input to digital Oscilloscope. <b>CAUTION:</b> APPLY 30 VRMS MAXIMUM.

## ITEM

## DESCRIPTION

8. DMM AMP Connector

Digital Multimeter (DMM) External Input Connector. Provides input to ac and dc Current Meter.

**CAUTION:** CURRENT INPUT ABOVE 2 A REQUIRES CURRENT SHUNT.

9. DMM COM Connector

Digital Multimeter External Input Common Connector. Provides common connection for DMM functions. Connect DMM Probe leads to connectors as follows:

DMM V $\Omega$  Connector (11) and DMM COM Connector for ac or dc voltage measurements.  
DMM AMP Connector (8) and DMM COM Connector for ac or dc current measurements.  
DMM V $\Omega$  Connector (11) and DMM COM Connector for resistance (ohms) measurements.

**NOTE:** A set of DMM Probes are included with IFR-1900.

10. SQLCH Keys

Increases ( $\uparrow$ ) or decreases ( $\downarrow$ ) Squelch level.

11. DMM V $\Omega$  Connector

Digital Multimeter External Input Connector. Provides input for the DMM ac or dc Voltmeter and Ohmmeter.

**CAUTION:** APPLY 30 VRMS MAXIMUM.

12. DEMODO OUT Connector

Provides demodulated audio or data from the Receiver.

13. EDIT Keysa. CE (Clear Entry) Key

Clears selected data entry field.

b. DEL (Delete) Key

Deletes preceding keystroke or character.

14. AUDIO OUT Connector

Provides demodulated audio from Receiver Module, Function Generator output from Monitor Module, EXT MOD signal or SINAD/BER signals for use by the UUT.

## ITEM

## DESCRIPTION

15. SINAD/BER IN Connector 

Provides access for signals to SINAD measurement or Bit Error Rate Meter Functions.

**CAUTION:** APPLY 10 VRMS MAXIMUM.

16. MEMORY and SPECIAL FUNCTION Keysa. SHIFT Key

Allows direct entry of hexadecimal digits and alpha characters. See Table 3-1 for a complete listing of "SHIFT" characters.

FRONT PANEL KEY	"SHIFT" CHARACTER	FRONT PANEL KEY	"SHIFT" CHARACTER
7	A	*	N
8	B	0	O
9	C	#	P
+/-	D	ENTER	Q
4	E	SETUP	R
5	F	CE	S
6	G	SQLCH ↑	T
M/μ	H	VOL ↑	U
1	I	STORE	V
2	J	RCL	W
3	K	DEL	X
K/m	L	SQLCH ↓	Y
• (Decimal Point)	M	VOL ↓	Z

Table 3-1 "SHIFT" Characters

b. RCL (Parameter Recall) Key

Recalls previously stored operation screen or test parameters from memory.

c. STORE (Parameter Storage) Key



Stores operation screen or test parameters in memory.

d. SETUP Key

Enters setup menu of present operation mode on the color display (26).

## ITEM

## DESCRIPTION

- 
17. EXT MOD IN Connector   
Connector for external modulation input from AM, FM or PM modulation sources.  
**CAUTION:** APPLY 10 VRMS MAXIMUM.
18. MIC/ACC Connector   
Used as microphone or accessory audio input/output connector.  
**CAUTION:** APPLY 2 Vpp MAXIMUM.
19. Soft Function Keys  
Functions of Soft Function Keys are dependent on the operating mode.
20. POWER ON Indicator  
Green LED illuminates when POWER Switch (22) is pressed to turn power on. LED goes off when POWER Switch (22) is pressed to turn power off.
21. POWER APPLIED Indicator  
Yellow LED illuminates when ac power is applied to IFR-1900.
22. POWER Switch  
Red power switch used to turn unit power on and off. Under extreme operating conditions (i.e., high temperature indication), power may be switched off under processor control.
23. Reserved
24. DUPLEX OUT Connector   
RF Generator output when unit is in Duplex Mode.  
**CAUTION:** ALTHOUGH DUPLEX OUT CONNECTOR FUNCTIONS ONLY AS AN OUTPUT DURING NORMAL OPERATION, DUPLEX OUT CONNECTOR IS PROTECTED TO A MAXIMUM CONTINUOUS INPUT OF 10 W.

## ITEM

## DESCRIPTION

25. ANTENNA IN Connector 
- Antenna Input Connector used to monitor low level "off the air" signals.
- CAUTION:** MAXIMUM CONTINUOUS INPUT TO ANTENNA IN CONNECTOR IS LIMITED TO 10 W.
- NOTE:** An Antenna is provided with the IFR-1900.
26. COLOR DISPLAY
- Provides visual information to operator via an active matrix LCD color display. The color display has a resolution of 640 x 480 pixel.
27. MODE Keys
- Each mode and respective screens and menus are covered in detail in 3-3.
- a. RF GEN Key  
Accesses RF Generator Operation Screen.
  - b. RCVR Key  
Accesses Receiver Operation Screen.
  - c. DPLX Key  
Accesses Duplex Operation Screen.
  - d. AF GEN Key  
Accesses AF Generator Operation Screen.
  - e. SCOPE/ANLZ Key  
Accesses Oscilloscope or Spectrum Analyzer Operation Screen.
  - f. MTRS Key  
Accesses Meter Menu to select Meter Operation.
28. TEST CONTROL Keys
- Used to enter test execution mode or function.
- a. AUTO Key  
Controls special functions.
  - b. SGL STEP (Single Step) Key  
Controls special functions.

## ITEM

## DESCRIPTION

c. GO Key

Starts operator controlled functions. Functions affected include Frequency Scan, Cable Fault, BER Tests, DTMF and Encode Functions.

d. STOP Key

Stops operator controlled functions. Functions affected include Frequency Scan Cable Fault, BER Tests, DTMF and Encode Functions.

e. PRINT SCRN Key

Prints what is currently on the color display when connected to an external printer.

f. HOLD SCRN Key

Freezes the current display on the color display.

29. DATA ENTRY Keypad

Provides direct entry of test set parameters into selected data field. Pressing ENTER, K/m or M/ $\mu$  Key ends data entry and returns field selection cursor. Parameters are changed only when ENTER Key or a "Scale and Unit" Key is pressed.

a. "0-9" (Numeric) and "." (Decimal point) Keys

Allows numeric data entry. Numeric keys automatically repeat if held in for more than one second and repeat at an approximate rate of two per second.

b. +/- Key

Toggles the sign of a selected data entry.

c. M/ $\mu$  and K/m Keys

Scale and Unit Keys, "M/ $\mu$ " ( $\times 10^6/\times 10^{-6}$ ) and "K/m" ( $10^3/\times 10^{-3}$ ), are used as multipliers for selected data entry. Toggles to multiply entry by selected factor.

d. ENTER Key

Accesses a selected field and enters selected data in its present configuration.







e. # and \* Keys

Used for DTMF Functions.

f. Alpha Keys





Alpha Keys are accessed by using the SHIFT Key along with the DATA ENTRY, MEMORY, EDIT, SQLCH and VOL Keys. Table 3-1 shows each key and associated alpha character.

## 3-2 IFR-1900 REAR PANEL

ITEM	DESCRIPTION
30. <u>AC FUSE Housing (2)</u>	
	115 VAC operation requires 4.0 A fuse. 230 VAC operation requires 2.0 A fuse.
31. <u>AC LINE IN Connector</u>	
	Provides input from ac power source (115 or 230 VAC). Internal power supply automatically adjusts to either voltage source. An ac power cord is included with the unit.
32. <u>SYNC OUT Connector</u>	
	See IFR-1900 CSA Option Operation Manual.
33. <u>GENERATOR BASEBAND OUT I</u>	
	See IFR-1900 CSA Option Operation Manual.
34. <u>GENERATOR BASEBAND OUT Q</u>	
	See IFR-1900 CSA Option Operation Manual.
35. <u>RECEIVER IF Connector</u>	
	Reserved for future use.
36. <u>SCSI (Small Computer System Interface) Bus</u>	
	Provides a standard, high speed, digital bus for communication.
37. <u>GPIB (IEEE-488) Connector</u>	
	Allows IFR-1900 to control other test modules, transfer test results, drive a plotter or be controlled by an external test controller.
38. <u>AUXILIARY I/O Connector</u>	
	Reserved for future use.
39. <u>HOST RS-232 Connector</u>	
	Allows IFR-1900 to communicate with any serial device, to control other test modules, upload and download parameter sets, transfer test results, drive a printer or be controlled by an external test controller. All commands or data available to the operator at Front Panel are available at RS-232 Connector.
40. <u>OPT. RS-232 Connector</u>	
	See IFR-1900 CSA Option Operation Manual.

## ITEM

## DESCRIPTION

- 
41. EXTERNAL VIDEO Connector   
Allows an external VGA (Video Graphics Array) monitor to be attached to IFR-1900. Attached monitor echoes current display.
42. PRINTER Connector  
Centronics compatible printer interface connection (25-pin D-sub connector). (Operational only with the CSA Option).
43. GENERATOR IF IN Connector   
Reserved for future use.
44. 10 MHz REFERENCE IN Connector   
Allows attachment of an external 10 MHz reference to IFR-1900. The internal RF circuitry locks to this input.
45. 10 MHz REFERENCE OUT Connector   
10 MHz reference frequency used within the IFR-1900 for external devices.
46. GENERATOR IF OUT Connector   
Reserved for future use.



### **3-3 OPERATION SCREENS AND MENU CONFIGURATIONS**

The operation screens of the IFR-1900 and their accompanying setup menus contain a great deal of information. This information displays differently according to the type of operation screen displayed, the configuration of the screen and signal type and input source used.

Operation screens are accessed by pressing any MODE Key except the MTRS Key. Menus for each operation screen are accessed by pressing the SETUP Key while that operating screen is displayed.

Pressing the MTRS MODE Key accesses the Meter Menu. The Meter Menu is used to access each Meter Operation Screen. Menus for individual Meters are accessed by pressing the SETUP Key while a Meter Operation Screen is displayed.

When editing, use the FIELD SELECT Keys to move the cursor to the parameter to be edited and press ENTER Key to access the data field. Use the DATA ENTRY Keypad to enter numerical data. Use the DATA SCROLL Spinner or DATA SCROLL ↑ and ↓ Keys to select parameters from a list. Parameters with only two possible settings, when selected, automatically switch to the opposite setting when pressing the ENTER Key.

### 3-3-1 RF GENERATOR OPERATION SCREEN

Pressing the RF GEN MODE Key accesses the RF Generator Operation Screen. The operation of the RF Generator may be controlled by changing Screen Parameters, using Soft Function Keys or Setup Menu.

**NOTE:** The output of the RF Generator is routed to the T/R Connector (6).

The following Screen Parameters portion identifies the operation screen parameters that are edited, the value range available and/or usage of each feature. When editing, use the FIELD SELECT Keys to move the cursor to the parameter to be edited and press ENTER Key to access the data field. Use the DATA ENTRY Keypad to enter numerical data. Use the DATA SCROLL Spinner or DATA SCROLL ↑ and ↓ Keys to select parameters from a list. Parameters with only two possible settings automatically switch to the opposite setting when selected. To access the Operation Screen of a displayed Meter, move cursor to the Meter and press the ENTER Key.

#### A. SCREEN PARAMETERS

The following index includes screen parameters and screen parameter attributes. Possible settings are listed where parameters can be changed from the operation screen.

ITEM	DESCRIPTION
------	-------------

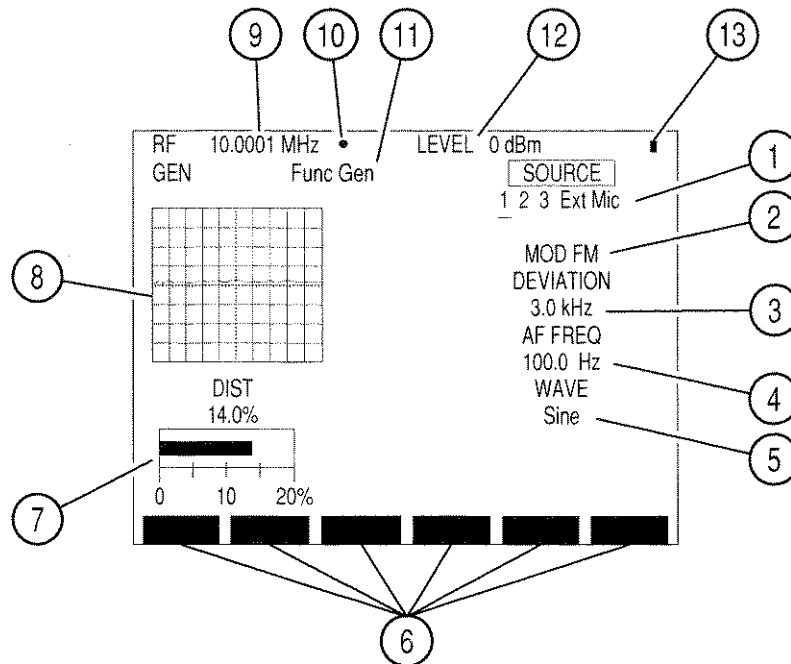

03407003

#### 1. Modulation Sources

Selects Sources and their Modulation. 1 is AF Generator 1, 2 is AF Generator 2, 3 is Signaling Formats, "Ext" is external signals received at the EXT MOD IN Connector and "Mic" is external sources received at the MIC/ACC Connector. Underline indicates last activated Source. Select AM, FM, PM or OFF for Modulation.

**NOTE:** Except for FM and PM, mixing Modulation types are allowed. Selecting FM for any source changes PM sources to FM. Selecting PM changes FM sources to PM. Sources that are AM or OFF are unaffected.

## ITEM

## DESCRIPTION

**NOTE:** Source 2 and 3 can be active simultaneously except when Source 3 is generating an Audio Signaling Code.

2. Modulation Type

Readout only. Readout indicates last activated Source Modulation Type. Indicates FM, AM, PM or OFF.

3. Modulation Level

Selects Modulation Level. Range is 0.0 to 100.0 kHz for FM Modulation, 0% to 90% for AM Modulation or 0.0 to 10.0 radians for PM Modulation.

**NOTE:** When Ext Source is selected, Modulation Level setting assumes the modulating signal applied to the EXT MOD IN Connector is 3.54 VRMS. Modulation Level settings are set higher for lower EXT MOD IN Connector input voltages to achieve the same modulation level as per the following equation:

$$\begin{array}{rcccl} \text{Modulation} & & \text{EXT MOD IN} & & \text{Actual} \\ \text{Level setting} & \times & \text{Connector} & \div & \text{Modulation} \\ \text{(kHz, \%, rad)} & & \text{Input (VRMS)} & & \text{Level} \\ & & & & 3.54 \end{array} =$$

4. AF FREQ

Appears if Source 1 or 2 is the last selected Source. Selects AF frequency. Range is from 0.0 to 40000.0 Hz.

5. WAVE

Appears if Source 1 or 2 is the last selected Source. Selects Wave Form. Select Sine, Square, Ramp, Triangle, Pulse, +1 Lvl, 0 Lvl or -1 Lvl.

6. Soft Function Keys

Soft Function Keys for RF Generator Operation Screen are covered in 3-3-1B.

7. Distortion/SINAD/AF Level/DMM Meter

Displays selected meter. Meter is selected using "Meters" Soft Function Key F4. Accessing Meter Callout displays Meters Operation Screen. Meter displayed as a digital readout if Scope or Analyzer is full size.

8. Oscilloscope or Spectrum Analyzer

Displays Oscilloscope or Spectrum Analyzer Operation. Use "Disp" Soft Function Key F1 to display full size or 1/4 size Oscilloscope, full size or 1/4 size Spectrum Analyzer or set to "None" for no display.

ITEM	DESCRIPTION
9. <u>RF Generator Frequency/Cellular Channel</u>	Selects frequency or cellular channel of RF signal generated. See Figure 3-3. <b>NOTE:</b> Frequency Callout turns yellow when Phase Lock is lost. To restore Frequency Callout after regaining Phase Lock, reselect the RF Generator Operation Mode.
10. <u>10 MHz External Reference Light</u>	Blue asterisk appears when 10 MHz External Reference signal is applied to the 10 MHz REFERENCE IN Connector.
11. <u>Oscilloscope Input</u>	Appears with Oscilloscope on. Select SINAD/BER, Func Gen, Ext Mod, AC, DC or GND.
12. <u>RF Generator Level</u>	If RF Generator Level Units are set to dBm, select from -137.0 to 0.0 dBm. If RF Generator Level Units are set to Volts, select from 0.031 $\mu$ V to 0.224 V. <b>NOTE:</b> The output of the RF Generator is routed to the T/R Connector (6).
13. <u>Scan Mode Indicator</u>	Blue dot appears when Scanning has been activated by either the GO or SGL STEP TEST CONTROL Keys (28). This indicator stays active until either the STOP TEST CONTROL Key (28) is pressed or the RF Generator Screen is exited. This indicator aids the user in determining when the instrument is scanning, and is useful if long pause times or scan rates are in process.

**Direct & Frequency Scan Modes**

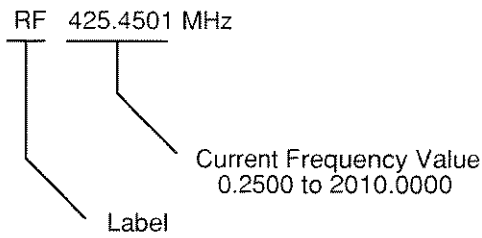

**Frequency List & Frequency List Scan Modes**

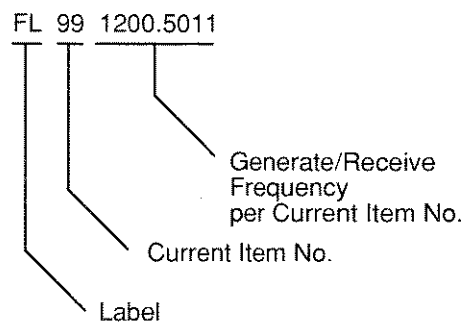

**Channel Mode\*\***

**NADC\* Format**

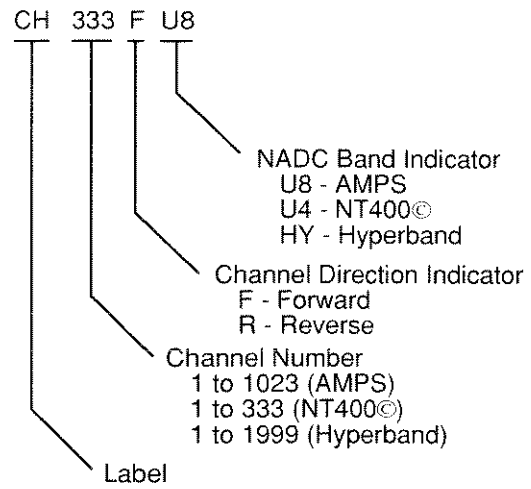

\* NADC - North American Digital Cellular

**NAMPS Format**

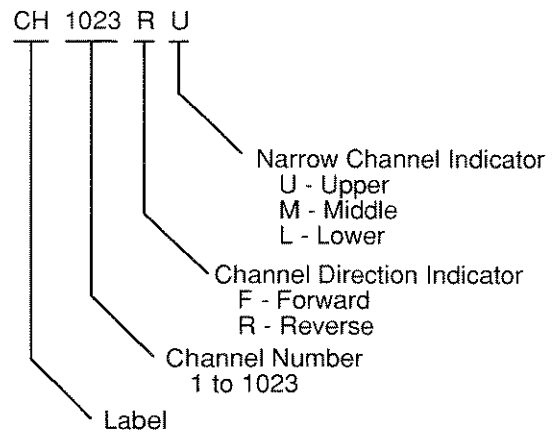

**E-TACS Format**

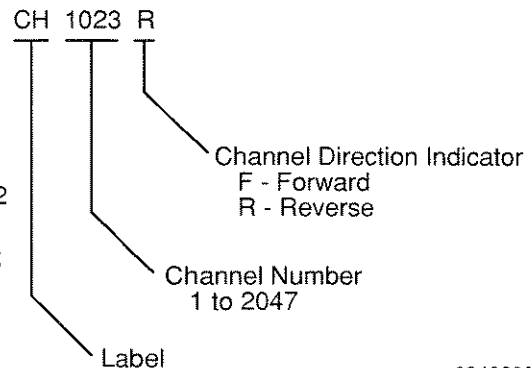

\*\* To select channel format, press "Chan" Soft Function Key F2 on the Setup Menu for the RF Generator, Receiver, Duplex, Duplex Transmitter and Duplex Receiver Operation screens; F1 for the Spectrum Analyzer screen.

03402001

Figure 3-3 RF Frequency / Cellular Channel Display Area

If Source 3 is the last activated Source, the Operation Screen appears as follows:

ITEM	DESCRIPTION
------	-------------

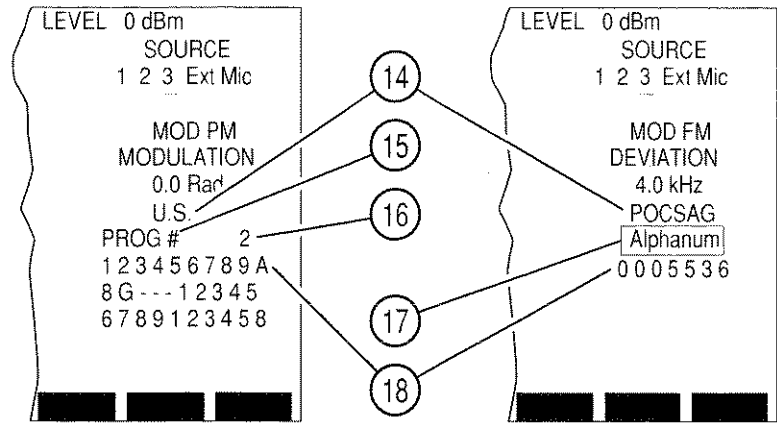

03407004

14. Signaling Code Display

- Displays DTMF if DTMF is the selected Signaling Format.
- Accesses Audio Code if Audio Signaling Format is active. Select from:

CCIR	EEA	U.S.(EIA)
ZVEI	DDZVEI (ZVEI 2)	DZVEI (ZVEI 3)
NATEL	EURO	5/6 Tone Seq
CCIRH	CCIRH4	User Defined

- Accesses Digital Code if Digital Signaling Format is active. Select from:

DCS	DCS INV	POCSAG
-----	---------	--------

- Accesses RCC Code if RCC Signaling Format is active. Select from:

IMTS	MTS	2805
Tone Rem		

**NOTE:** Signaling Format Type is set from the RF Generator Menu.

15. DIRECT ENTRY/PROG #

Accessing Callout toggles it to the other function. Select PROG # to generate a programmed sequence. Select DIRECT ENTRY to allow sequence entry from the Operation Screen. Press GO TEST CONTROL Key to continuously generate a sequence. Press STOP TEST CONTROL Key to stop generating the sequence. Press SGL STEP CONTROL Key to generate the sequence once.

16. Program Number

Does not appear if DIRECT ENTRY is active. Up to 16 sequences can be programmed.

## ITEM

## DESCRIPTION

17. POCSAG or Tone Remote Callout

Accesses POCSAG or Tone Remote Function. For POCSAG, select one of the following:

Tone - 1 beep  
Tone - 4 beeps  
Alpha lower  
Alpha special

Tone - 2 beeps  
Numeric  
Alpha upper

Tone - 3 beeps  
Numeric seq  
Alphanumeric

For Tone Remote, select one of the following:

2050 (Monitor)  
1750 (R2 Mute)  
1450 (Repeater On)  
1150 (Wild Card 2 On)

1950 (F1)  
1650 (R2 Unmute)  
1350 (Wild Card 1 On)  
1050 (Wild Card 2 Off)

1850 (F2)  
1550 (Repeater Off)  
1250 (Wild Card 1 Off)

18. Tone Sequence Listing

Displays coded sequence. If DIRECT ENTRY is selected, accessing allows entry of sequence unless POCSAG or Tone Remote is in use.

## B. SOFT FUNCTION KEYS

The following index lists the Soft Function Key sets available for the RF Generator Operation Screen.

ITEM	DESCRIPTION
------	-------------

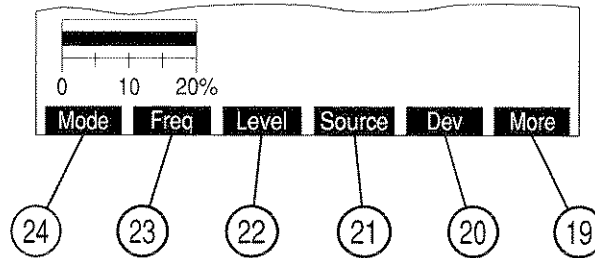

03407005

### 19. "More"/"ESC" Soft Function Key F6

"ESC" appears while parameters are accessed for editing. Allows edit procedure to be canceled without changing parameter. "More" displays additional sets of Soft Function Keys.

### 20. "Dev"/"Mod" Soft Function Key F5

Appears if Modulation is not "OFF." Selects Modulation Level, with a range of 0 to  $\pm 100$  kHz for FM, 0% to 90% for AM or 0.0 to 10.0 radians for PM.

### 21. "Source" Soft Function Key F4

Selects Modulation Source. Select OFF, AM, FM or PM for each Source.

### 22. "Level" Soft Function Key F3

Selects RF Generator Signal Level. Select from -137.0 to 0.0 for dBm Level Units. Select from 0.031  $\mu$ V to 0.224 V for voltage Level Units.

**NOTE:** The output of the RF Generator is routed to the T/R Connector (6).

### 23. "Freq" Soft Function Key F2

Selects RF Generator Frequency or Cellular Channel. See Figure 3-3.



24. "Mode" Soft Function Key F1

Selects RF Generator Operation Mode. Select Direct (normal operation), Channel, Freq Scan, Freq List, or Freq List Scan. If Channel Mode is selected, select Cellular Channel Format using "Chan" Soft Function Key F2 from the RF Generator Menu. Freq Scan Mode allows for scanning while in this screen. Independent scan parameters are specified in the RF Generator Setup Menu. When in Freq List or Freq List Scan Mode, the RF Generator Screen shares a common frequency list (See 3-3-1c.) with screens specified in 3-3-2, 3-3-4 and 3-3-5.

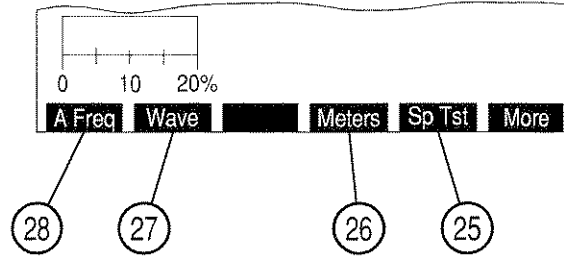

03407006

25. "Sp Tst" Soft Function Key F5

Displays Dual Mode IS-136 Cellular Menu.

26. "Meters" Soft Function Key F4

Displays submenu of available Meters. Select SINAD, DIST (Distortion), AF LVL or DMM.

**NOTE:** SINAD, Distortion and AF Level Meters measure only SINAD/BER IN Connector Input. DMM measures only DMM Connector Input.

27. "Wave" Soft Function Key F2

Appears if Source 1 or 2 is the last selected Source. Selects Wave Form. Select Sine, Square, Ramp, Triangle, Pulse, +1 Lvl, 0 Lvl or -1 Lvl.

28. "A Freq" Soft Function Key F1

Appears if Source 1 or 2 is the last selected Source. Selects AF Frequency. Select from 0.0 to 40000.0 Hz.

## ITEM

## DESCRIPTION

The following set of Soft Function Keys are accessed when a full size Spectrum Analyzer is used:

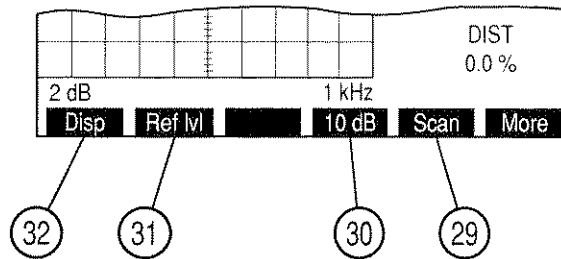

8617028

29. "Scan" Soft Function Key F5

Selects Spectrum Analyzer Scan Width. Select from the following:

(0 kHz) Zero Scan	1 kHz	2 kHz
5 kHz	10 kHz	20 kHz
50 kHz	100 kHz	200 kHz
500 kHz	1 MHz	

30. "10 dB/2 dB" Soft Function Key F4

Selects Units/Division Factor. Toggles between 10 and 2 dB/div.

31. "Ref lvl" Soft Function Key F2

Appears when 2 dB/div scale is active. Adjusts vertical trace position on Spectrum Analyzer.

32. "Disp" Soft Function Key F1

Accesses menu listing Oscilloscope and Spectrum Analyzer displays. Select full or 1/4 size displays for Oscilloscope or Spectrum Analyzer or select none.

The following set of Soft Function Keys are accessed when an Oscilloscope is in use:

ITEM	DESCRIPTION
------	-------------

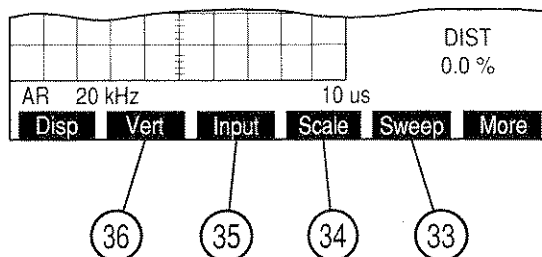

8617034

33. "Sweep" Soft Function Key F5

Appears with full size Oscilloscope. Selects Oscilloscope Sweep Rate. Select one of the following:

- |             |             |             |
|-------------|-------------|-------------|
| 1 $\mu$ s   | 2 $\mu$ s   | 5 $\mu$ s   |
| 10 $\mu$ s  | 20 $\mu$ s  | 50 $\mu$ s  |
| 100 $\mu$ s | 200 $\mu$ s | 500 $\mu$ s |
| 1 ms        | 2 ms        | 5 ms        |
| 10 ms       | 20 ms       | 50 ms       |
| 100 ms      |             |             |

34. "Scale" Soft Function Key F4

Appears with full size Oscilloscope except for SINAD/BER Oscilloscope Input. For AC, DC or GND Oscilloscope Input, select one of the following:

- |            |            |            |
|------------|------------|------------|
| 1 mV/div   | 2 mV/div   | 5 mV/div   |
| 10 mV/div  | 20 mV/div  | 50 mV/div  |
| 100 mV/div | 200 mV/div | 500 mV/div |
| 1 V/div    | 2 V/div    | 5 V/div    |
| 10 V/div   | 20 V/div   | 50 V/div   |

For Func Gen or Ext Mod Oscilloscope Input, select one of the following:

- |            |         |           |
|------------|---------|-----------|
| 500 mV/div | 1 V/div | 2.5 V/div |
|------------|---------|-----------|

Oscilloscope Scale is fixed at 4 V/div for SINAD/BER Oscilloscope Input.

35. "Input" Soft Function Key F3

Selects Oscilloscope Input. Select one of the following:

- |           |          |         |
|-----------|----------|---------|
| SINAD/BER | Func Gen | Ext Mod |
| AC        | DC       | GND     |

36. "Vert" Soft Function Key F2

Appears with full size Oscilloscope. Adjusts vertical trace position on Oscilloscope grid. When Oscilloscope Trace is adjusted below Oscilloscope display, an arrow appears on the right bottom edge of the display. When Oscilloscope Trace is adjusted above Oscilloscope display, an arrow appears on the right top edge of the display.

### C. RF GENERATOR MENU

When the RF Generator Operation Screen is displayed on the color display, pressing SETUP Key accesses the RF Generator Menu.

MENU ITEM	DESCRIPTION
-----------	-------------

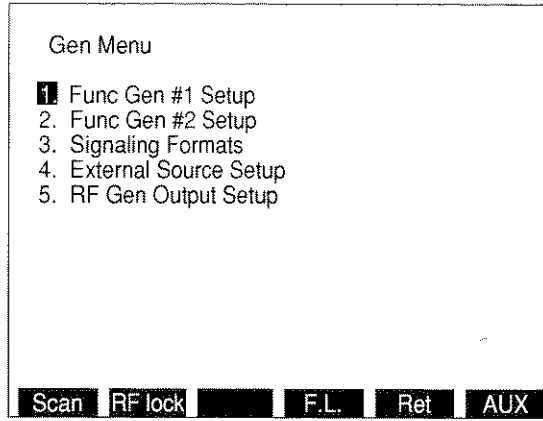

8616001

1. Func Gen #1 Setup

Displays Function Generator #1 Menu.

2. Func Gen #2 Setup

Displays Function Generator #2 Menu.

3. Signaling Formats

Displays Signaling Format Menu featuring DTMF, Audio, Digital and RCC.

4. External Source Setup

Displays External Source Setup Menu.

5. RF Gen Output Setup

Displays RF Generator Setup Menu.

The following set of Soft Function Keys are available with the RF Generator Menu.

ITEM	DESCRIPTION
------	-------------

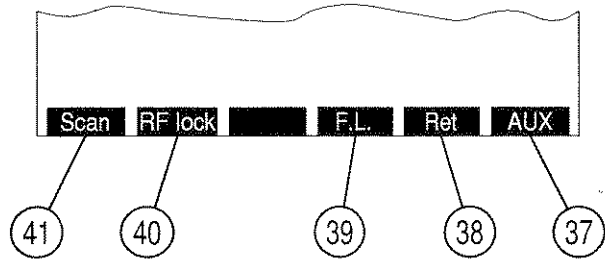

03407007

37. "AUX"/"ESC" Soft Function Key F6

"ESC" appears while parameters are accessed for editing. Allows edit procedure to be canceled without changing parameter. "AUX" displays Auxiliary Functions Menu.

38. "Ret" Soft Function Key F5

Returns operation to RF Generator Operation Screen.

39. "F.L." Soft Function Key F4

Displays the Frequency List Setup Screen.

ITEM	DESCRIPTION
------	-------------

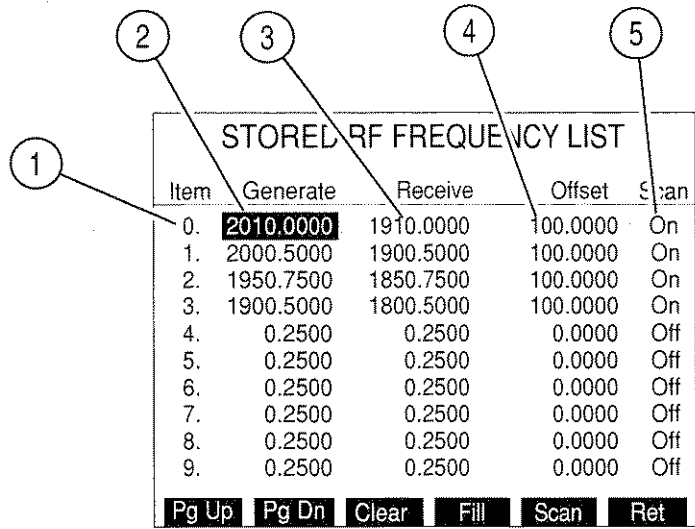

03416001

1. Item

Identifies each line in the RF Frequency List. There are 100 (0 to 99) lines with 10 on the screen at a time.

ITEM	DESCRIPTION
2. <u>Generate</u>	The column of frequencies for the RF Generator and Duplex Receiver operations. Use FIELD SELECT Keys (1) to move cursor to an item line in the Generate column and press ENTER Key to activate data field. Use DATA ENTRY Keypad (29) to enter desired frequency and press ENTER Key.
3. <u>Receive</u>	The column of frequencies for the Receiver and Duplex Transmitter operations. Use FIELD SELECT Keys (1) to move cursor to an item line in the Receive column and press ENTER Key to activate data field. Use DATA ENTRY Keypad (29) to enter desired frequency and press ENTER Key.
4. <u>Offset</u>	The column which specifies or reflects the difference between Generate and Receive frequency columns. If a value is entered into this column, the value in the Generate column is changed to maintain the difference between Generate and Receiver frequencies specified. The difference between Generate and Receive frequencies is equal to Generate minus Receive. Use FIELD SELECT Keys (1) to move cursor to an item line in the Offset column and press ENTER Key to activate data field. Use DATA ENTRY Keypad (29) to enter desired frequency and press ENTER Key.
5. <u>Scan</u>	Used for Frequency List Scan Mode only. Item lines are skipped during scanning if Scan is turned off. Use FIELD SELECT Keys (1) to move cursor to an item line in the Scan column and press ENTER Key to toggle between On or Off.

The following set of Soft Function Keys are available with the Frequency List Setup Screen:

ITEM	DESCRIPTION
11	Pg Up
10	Pg Dn
9	Clear
8	Fill
7	Scan
6	Ret

8616019

6. "Ret" Soft Function Key F6

Returns to last operation screen accessed.

ITEM	DESCRIPTION
7. <u>"Scan" Soft Function Key F5</u>	<p>Displays the RF Generate Frequency Scan List Menu.</p> <ul style="list-style-type: none"> <li data-bbox="347 352 542 382">● <u>Scan Rate</u></li> </ul> <p>This is the rate at which the Generator hops to the next frequency. Range is 0.02 to 99.99 sec.</p>
8. <u>"Fill" Soft Function Key F4</u>	<p>When pressed, fills or repeats the frequency value selected by the cursor for each of the items below the cursor and in the same column.</p>
9. <u>"Clear" Soft Function Key F3</u>	<p>Returns the selected element of the Generate, Receive, Offset or Scan columns to the default value. Generate and Receive frequencies are returned to 0.2500 MHz. Offset frequencies are returned to zero. Scan is returned to OFF.</p>
10. <u>"Pg Dn" Soft Function Key F2</u>	<p>When pressed, displays the following page of 10 item lines in the Stored RF Frequency List.</p>
11. <u>"Pg Up" Soft Function Key F1</u>	<p>When pressed, displays the previous page of 10 item lines in the Stored RF Frequency List.</p>

ITEM

DESCRIPTION

40. "RF lock"/"Chan" Soft Function Key F2

- "RF lock" Soft Function Key F2 is displayed for Direct RF Generator Format. Activates RF Lock Function, locking RF Generator Frequency to Receiver RF Frequency and Analyzer RF Frequency. Last frequency entered from among the frequencies locked is the frequency locked on. "RF lock" appears in red when RF Lock Function is active.
- "Chan" Soft Function Key F2 is displayed for Channel RF Generator Format. Displays RF Generator Channel Format Menu.

41. "Scan" Soft Function Key F1

Displays RF Generator Frequency Scan Menu.

MENU ITEM

DESCRIPTION

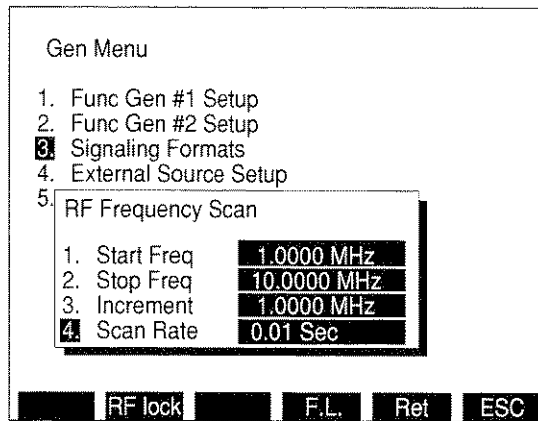

8610333

1. Start Freq

Selects starting frequency for RF Frequency Scan. Range is from 0.2500 to 2010.0000 MHz.

2. Stop Freq

Selects upper limit frequency for RF Frequency Scan. Range is from 0.2500 to 2010.0000 MHz.

3. Increment

Selects increment between scanned frequencies. Range is from 0.0000 to 2010.0000 MHz.

4. Scan Rate

Selects time period for each generated frequency. Range is from 0.02 to 99.99 sec.



Selecting "1. Func Gen #1 Setup" displays the Function Generator #1 Setup Menu.

MENU ITEM	DESCRIPTION
-----------	-------------

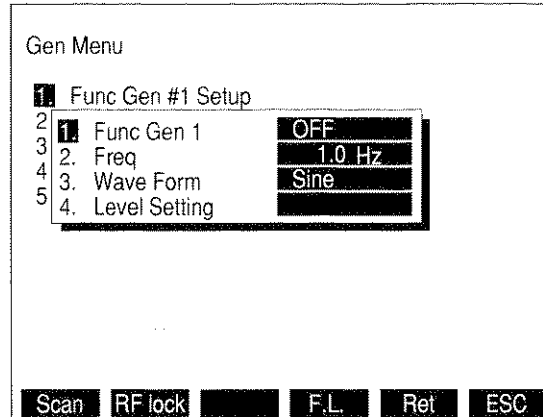

8610334

1. Func Gen 1

Selects Function Generator Modulation Type. Choose AM, FM, PM or OFF.

**NOTE:** Except for FM and PM, mixing Modulation types are allowed. Selecting FM for any source changes PM sources to FM. Selecting PM changes FM sources to PM. Sources that are AM or OFF are unaffected.

2. Freq

Selects Function Generator Frequency. Range is from 0.0 to 40000.0 Hz.

3. Wave Form

Selects Function Generator Wave Form. Choose Sine, Square, Ramp, Triangle, Pulse, +1 Lvl, 0 Lvl or -1 Lvl.

4. Level Setting

Appears only when Function Generator is On. Selects Function Generator Modulation Level. Range is from 0.0 to 100.0 kHz for FM Deviation, 0% to 90% for AM Modulation and 0.0 to 10.0 radians for PM Modulation.

Accessing "2. Func Gen #2 Setup" displays the Function Generator #2 Menu. Function Generator #2 parameters are identical to those of Function Generator #1.

When "3. Signaling Formats" is selected on the Generator Menu, the following menu appears on the color display:

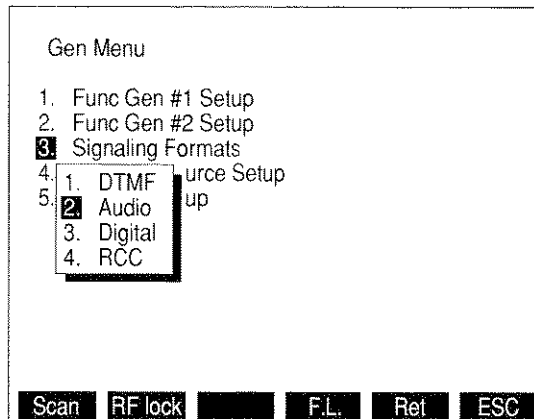

8610335

If DTMF is selected, the DTMF Format Menu appears on the screen:

ITEM	DESCRIPTION
42	Id
43	Timing
44	Sequence
45	Mod
46	

Id	Timing	Sequence	Mod	
1	User	1234567890ABCD12	FM	4.0
2	Std	---	OFF	
3	Std	---	OFF	
4	Std	---	OFF	
5	Std	---	OFF	

03416002

42. Id

Program Identification number. Used to select a specific sequence from the Operation Screen while using the Program feature. Select 1 to 16.

43. Timing

Selects Std (standard) or User (user defined). If User is selected, two data fields appear allowing entry of desired Mark Timing and Space Timing. Range of both is 25 to 9999 ms.

44. Sequence

Selects the desired sequence of up to 15 tones using digits 0 through 9, letters A through D, # character and the \* character.

ITEM	DESCRIPTION
------	-------------

45. Mod Type

Selects AM, FM, PM or OFF for the DTMF modulation.

46. Mod Level

Modulation Level range is 0.0 to 10.0 kHz for FM, 0.0% to 12.5% for AM or 0.0 to 1.5 radians for PM.

If Audio is selected as the Signaling Format, the RF Generator Audio Signaling Format Menu appears on the screen listing 12 Audio Signaling Codes:

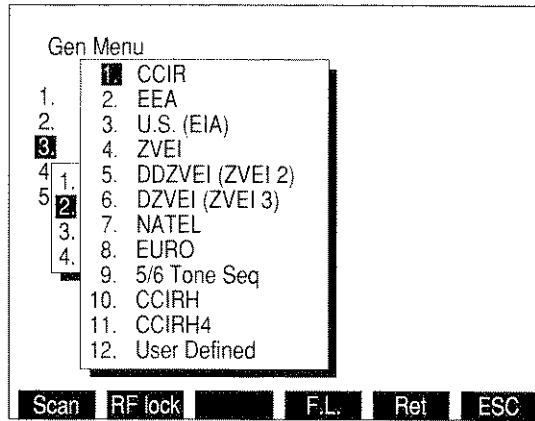

8610337

Selecting an Audio Code displays the Audio Code Sequence Menu:

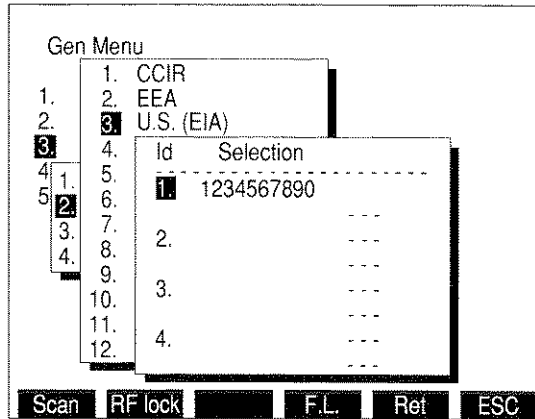

8610338

Select an Id number from 1 to 16. Enter a sequence up to 30 tones in length using the characters 0 through 9, A, G, R and - (signifying a blank space).

Selecting "12. User Defined" for the Audio Code displays the Audio Code User Defined Menu:

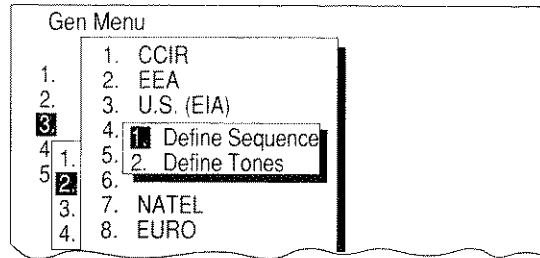

8610159

Selecting "2. Define Tones" displays a menu used to define the desired tones.

ITEM DESCRIPTION

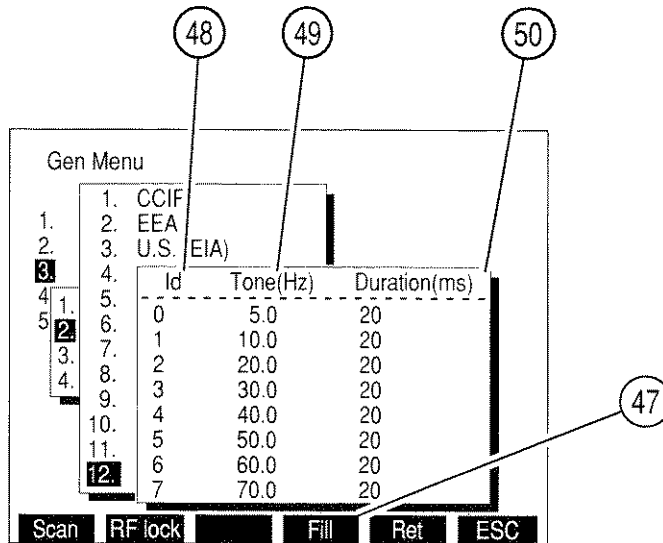

03416003

47. "Fill" Soft Function Key F4

When a Tone or Duration is highlighted, pressing "Fill" Soft Function Key F4 changes all entries below and in the same column to the value highlighted.

48. Id

Identification Number representing the tone to be defined. Range of characters for the Id is 0 to 9 and A to T. Defining the tone consists of setting the frequency and duration of the tone.

49. Tone(Hz)

Set "Tone(Hz)" to frequency of desired tone. Range is 0.0 to 9999.9 Hz.

50. Duration(ms)

Set "Duration(ms)" to duration of desired tone. Range is 20 to 9999 ms.

Selecting "Define Sequence" displays the RF Generator Audio Code Sequence Menu. User Defined sequences are selected as other Audio Codes using this menu.

If Digital is selected as the Signaling Format, the Digital Code Menu appears:

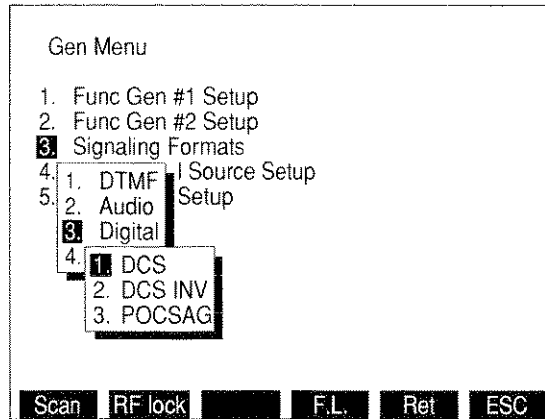

8610339

Selecting DCS or DCS INV displays the DCS Code Menu:

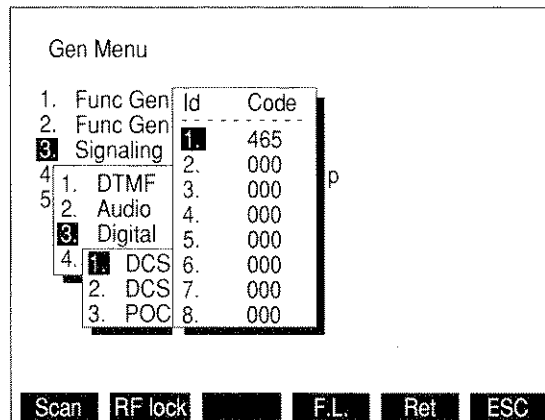

8610340

After selecting the Id number (1 to 16), a 3 digit DCS Code is entered.

Selecting POCSAG from the Digital Code Menu displays the POCSAG Menu:

MENU ITEM	DESCRIPTION
-----------	-------------

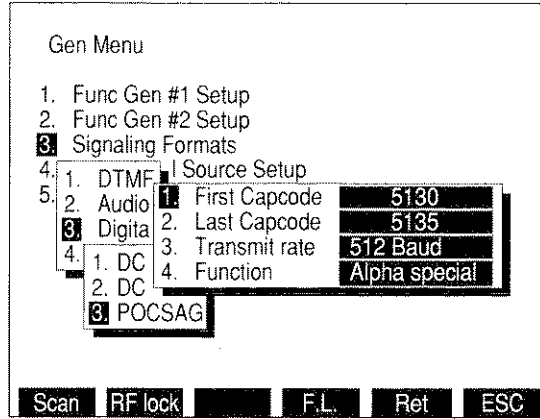

8616004

1. First Capcode

Selects beginning Capcode of sequence. Range of Capcodes is 1 to 2097151. Sequence generated consists of Capcodes from First Capcode through Last Capcode.

2. Last Capcode

Selects ending Capcode of Capcode sequence. Range of Capcodes is 1 to 2097151. Sequence generated consists of Capcodes from First Capcode through Last Capcode.

3. Transmit rate

Selects Transmit Rate submenu. Choose 512 Baud or 1200 Baud.

4. Function

Displays POCSAG Function submenu. Choose one of the following:

Tone - 1 beep	Tone - 2 beeps	Tone - 3 beeps
Tone - 4 beeps	Numeric	Numeric seq
Alpha lower	Alpha upper	Alphanumeric
Alpha special		

If RCC is selected for the Signaling Format, the RCC Code Menu appears:

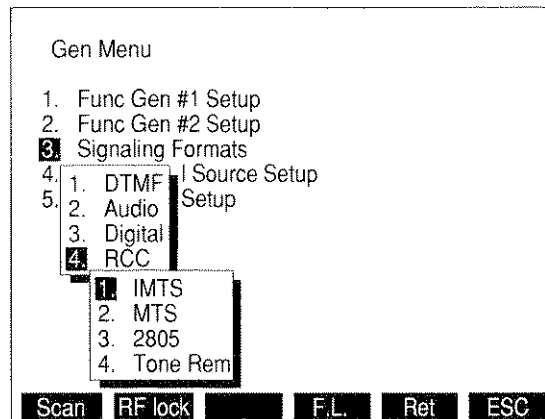

8610341

Selecting IMTS, MTS or 2805 displays the following menu:

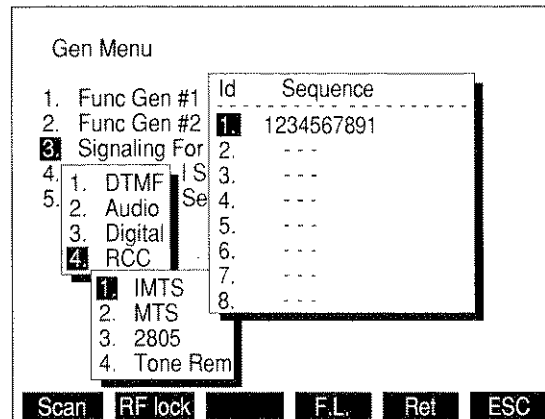

8610342

After selecting an Id, select the sequence to be generated using characters 1 through 9.

If 2805 is selected, "Tone" Soft Function Key F3 appears. Accessing F3 displays the 2805 Tone Freq data field allowing this frequency to be changed. Range of Tone Freq is 0.0 to 40000.0 Hz.

Selecting Tone Rem displays the Tone Remote Function Menu. Select one of the following:

- |                       |                        |                        |
|-----------------------|------------------------|------------------------|
| 2050 (Monitor)        | 1950 (F1)              | 1850 (F2)              |
| 1750 (R2 Mute)        | 1650 (R2 Unmute)       | 1550 (Repeater Off)    |
| 1450 (Repeater On)    | 1350 (Wild Card 1 On)  | 1250 (Wild Card 1 Off) |
| 1150 (Wild Card 2 On) | 1050 (Wild Card 2 Off) |                        |

When "4. External Source Setup" is selected on the Generator Menu, the following menu appears on the color display:

MENU ITEM	DESCRIPTION
-----------	-------------

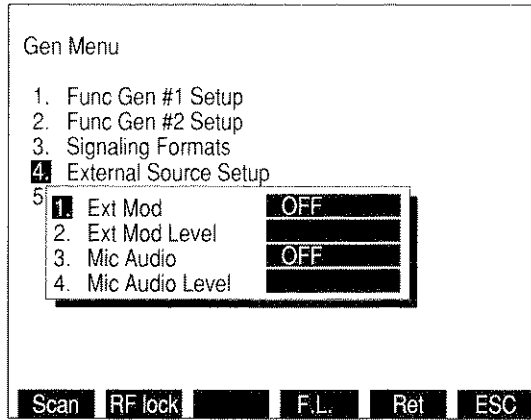

8610343

1. Ext Mod

Select FM, AM, PM or OFF for the External Modulation Type.

2. Ext Mod Level

Selects External Modulation Level. Select from 0.0 to 100.0 kHz for FM, 0% to 90% for AM or 0.0 to 10.0 radians for PM. Field is blank if set to OFF.

**NOTE:** External Modulation Level setting assumes the modulating signal applied to the EXT MOD IN Connector is 3.54 VRMS. For lower input voltages, Modulation Level setting is set higher to achieve the modulation level desired as per the following equation:

$$\begin{array}{rcccl} \text{Modulation} & & \text{EXT MOD IN} & & \text{Actual} \\ \text{Level setting} & \times & \text{Connector} & \div & \text{Modulation} \\ \text{(kHz, \%, rad)} & & \text{Input (VRMS)} & & \text{Level} \\ & & & & 3.54 \end{array} =$$

3. Mic Audio

Select FM, AM, PM or OFF for Microphone Input Modulation Type.

4. Mic Audio Level

Selects Microphone Input Modulation Level. Select from 0.0 to 100.0 kHz for FM, 0% to 90% for AM or 0.0 to 10.0 radians for PM. Field is blank if set to OFF.



When "5. RF Generator Setup" is selected on the Generator Menu, the RF Generator Setup Menu appears on the color display:

MENU ITEM DESCRIPTION

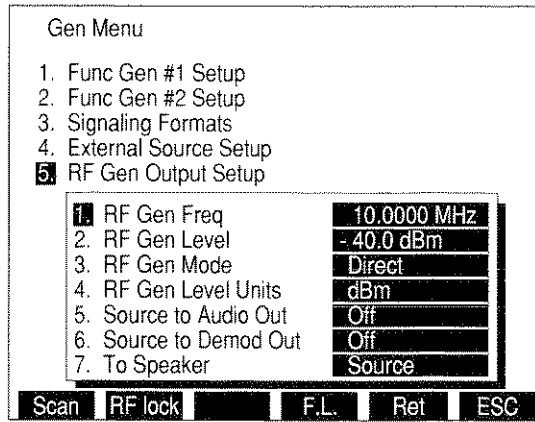

03416118

1. RF Gen Freq

Selects RF Generator Frequency or Cellular Channel. For a Frequency Mode, select from 0.2500 to 2010.0000 MHz. For Channel Mode, select from 1 to 2047, depending on channel format.

2. RF Gen Level

Selects RF Generator Output Level. If RF Generator Level Units are set to dBm, range is from -137.0 to 0.0 dBm. If RF Generator Level Units are set to Volts, range is from 0.031  $\mu$ V to 0.224 V.

**NOTE:** The output of the RF Generator is routed to the T/R Connector (6).

3. RF Gen Mode

Selects RF Generator Mode. Displays RF Gen Mode Submenu. Allows selection of Direct (normal operation), Channel, Freq Scan, Freq List or Freq List Scan. Freq Scan Mode allows for scanning while in the RF Generate Operation Screen. Independent scan parameters are specified in the Stored RF Frequency List, accessible by means of "F.L." Soft Function Key F4. When in Freq List or Freq List Scan Mode, the RF Generator Operation Screen shares a common frequency list with the Receive, Duplex, Duplex Transmitter and Duplex Receiver Operation Screens.

MENU ITEM

DESCRIPTION

"Chan" Soft Function Key F2 appears when Channel Mode is selected. When the "Chan" Soft Function Key F2 is selected, the RF Generator Channel Format Menu appears listing available Cellular Channel Formats:

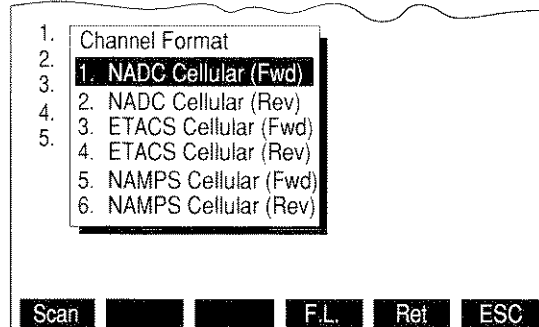

03416004

If an NADC Cellular channel format is selected, the NADC Cellular format menu appears:

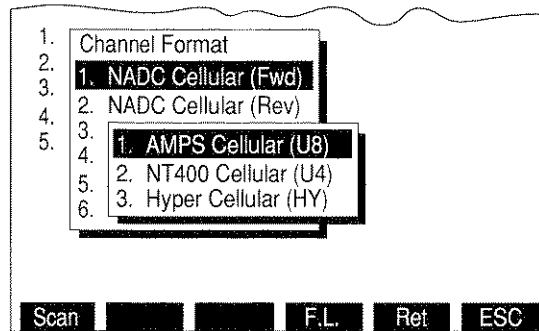

03416005

The operator may select AMPS, NT400© or Hyperband channel format.

4. RF Gen Level Units

Selects RF Generator Output Level Units. Toggles units to dBm or Volts.

5. Source to Audio Out

Sets routing of selected Source to AUDIO OUT Connector. Accessing toggles routing On or Off.

6. Source to Demod Out

Sets routing of selected Source to DEMOD OUT Connector. Accessing toggles routing On or Off.

7. To Speaker

Displays menu listing signals to be routed to Speaker. Select None, Source, SINAD/BER or Ext Mod/DTMF.

**NOTE:** Routing the Source to the Speaker disables SINAD and Distortion Meters.

### 3-3-2 RECEIVE OPERATION SCREEN

Pressing RCVR MODE Key accesses Receive Operating Screen. The operation of the Receiver may be controlled by changing Screen Parameters, using Soft Function Keys or Setup Menu.

The following Screen Parameters portion identifies the operation screen parameters that are edited, the value range available and/or usage of each feature. When editing, use the FIELD SELECT Keys to move the cursor to the parameter to be edited and press ENTER Key to access the data field. Use the DATA ENTRY Keypad to enter numerical data. Use the DATA SCROLL Spinner or DATA SCROLL ↑ and ↓ Keys to select parameters from a list. Parameters with only two possible settings automatically toggle to the opposite setting when selected. To access the Operation Screen of a displayed Meter, move cursor to the Meter and press the ENTER Key.

#### A. SCREEN PARAMETERS

The following index includes screen parameters and screen parameter attributes. Possible settings are listed where parameters can be changed from the operation screen.

ITEM	DESCRIPTION
------	-------------

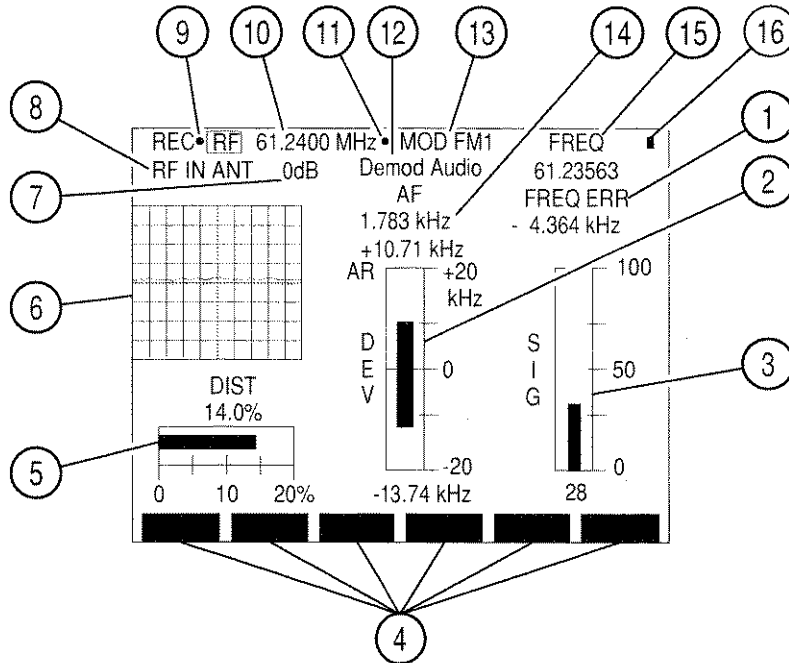

03416006

#### 1. FREQ ERR

Display for Frequency Error Counter. Frequency Error Counter indicates difference between received frequency and Receive Frequency setting.

#### 2. Deviation Meter/Modulation Meter/Phase Meter

Appears for all modulation types except BFO. Selects Deviation Meter for FM Modulation, Modulation Meter for AM Modulation, or Phase Meter for PM Modulation.

ITEM	DESCRIPTION
------	-------------

3. Signal Strength Meter/Power Meter

Displays Signal Strength Meter (if ANTENNA IN Connector is selected as Receiver Input Source) or Power Meter (if T/R Connector is selected as Receiver Input Source).

4. Soft Function Keys

Soft Function Keys for the Receive Operation Screen are covered in 3-3-2B.

5. Distortion/SINAD/Deviation (RMS)/Phase (RMS) Meter/DMM

Appears for all modulation types except BFO. Meter is selected using "Meters" Soft Function Key.

6. Oscilloscope/Spectrum Analyzer/Decode Display

Use "Disp" Soft Function Key to display full size or 1/4 size Oscilloscope, full size or 1/4 size Spectrum Analyzer or set to Decode for the Decode Display. Meters are reduced to digital readouts when a full size display is selected.

7. Receiver Input Attenuation Level

Selects RF Input Attenuation Level. Select one of the following:

0 dB	5 dB	10 dB
15 dB	20 dB	25 dB
30 dB	LNA*	

\*LNA (Low Noise Amplifier) has the same attenuation as 0 dB, but LNA has a lower noise figure. (**NOTE:** LNA is the preferred option for doing off-the-air applications.)

8. Receiver Input Source

Selects "ANT" (ANTENNA IN) or "T/R" Connector. If "ANT" is selected, the Signal Strength Meter is displayed. If "T/R" is selected, the Power Meter is displayed.

9. Squelch Indicator Light

Green dot appears when squelch is broken.

10. Receiver Frequency/Cellular Channel

Selects frequency or cellular channel of RF signal received. See Figure 3-3.

**NOTE:** Frequency Callout turns yellow when Phase Lock is lost. To restore Frequency Callout after regaining Phase Lock, reselect the Receiver Operation Mode.

11. 10 MHz External Reference Light

Blue asterisk appears when 10 MHz External Reference Signal is applied to the 10 MHz REFERENCE IN Connector.

## ITEM

## DESCRIPTION

12. Oscilloscope Input/Analyzer Reference Level

If an Oscilloscope is displayed, select Oscilloscope Input from Rcvr IF, Demod Audio, RF Pwr Lvl, SINAD/BER, Func Gen, Ext Mod, AC, DC or GND. If a full size Analyzer is displayed, field shows the Analyzer Reference Level. Field is blank otherwise.

13. Receiver Modulation Type

Selects Receiver Modulation Type. Table 3-2 lists available modulation types and parameters.

MODE	RECEIVER IF BANDWIDTH	AUDIO BANDWIDTH (POST DETECTION FILTER)	RECOMMENDED USE
FM1	30 kHz	3 kHz	Land mobile radios at low modulation rates.
FM2	30 kHz	10 kHz	Land mobile radios at moderate modulation rates.
FM3	300 kHz	20 kHz	Commercial FM transmitters or wide-deviation FM transmitters at medium modulation rates.
FM4	300 kHz	75 kHz	Commercial FM transmitters or wide-deviation FM transmitters at high modulation rates.
AM1	2.9 kHz	3.0 kHz	Off the air AM monitoring.
AM2	30 kHz	10 kHz	Direct-connection AM monitoring.
PM	30 kHz	3.0 kHz	Used to demodulate phase modulated signals.
BFO	-	-	Used to generate tone for testing Continuous Wave carriers.
User Defined	3 kHz 30 kHz 300 kHz	All Pass, C weight Low Pass (0.1 to 30 kHz) High Pass (0.5 to 20 kHz) Bandpass (0.5 to 30 kHz)	General purpose usage as defined by user.

Table 3-2 Receiver Modulation Type Parameters

ITEM	DESCRIPTION
14. <u>Receive Audio Frequency Counter</u>	Displays Audio Frequency Received. Readout only.
15. <u>RF Frequency Meter</u>	Displays RF Frequency Received. Readout only.
16. <u>Scan Mode Indicator</u>	Blue dot appears when Scanning has been activated by either the GO or SGL STEP TEST CONTROL Keys (28). This indicator stays active until either the STOP TEST CONTROL Key (28) is pressed or the Receiver Screen is exited. This indicator aids the user in determining when the instrument is scanning, and is useful if long pause times or scan rates are in process.

## B. SOFT FUNCTION KEYS

The following index lists Soft Function Keys available for the Receiver Operation Screen:

ITEM	DESCRIPTION
------	-------------

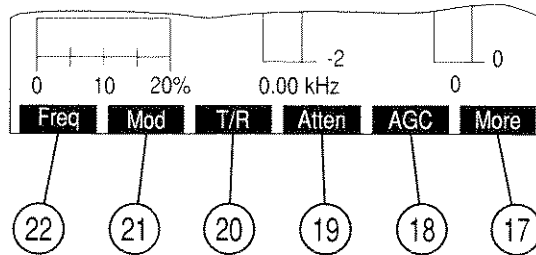

03416007

### 17. "More"/"ESC" Soft Function Key F6

"ESC" appears while parameters are accessed for editing. Allows edit procedure to be canceled without changing parameter. "More" displays additional sets of Soft Function Keys.

### 18. "AGC" Soft Function Key F5

Appears when Automatic Gain Control is set to Manual. Adjusts the AGC using the DATA SCROLL Spinner.

**NOTE:** To view the current setting of manual AGC, see the Receiver Menu.

### 19. "Atten" Soft Function Key F4

Selects RF Input Attenuation Level. Select one of the following:

0 dB	5 dB	10 dB
15 dB	20 dB	25 dB
30 dB	LNA*	

\*LNA (Low Noise Amplifier) has the same attenuation as 0 dB, but LNA has a lower noise figure. (**NOTE:** LNA is the preferred option for doing off-the-air applications.)

### 20. "T/R" or "Ant" Soft Function Key F3

Selects Receiver Input Source. Access toggles Source to T/R Connector or Ant (ANTENNA IN) Connector.

### 21. "Mod" Soft Function Key F2

Selects Receiver Modulation Type. Choose one of the following:

AM1	AM2	FM1
FM2	FM3	FM4
BFO	PM	User Defined

**NOTE:** See Table 3-2 for description of modulation types. User Defined Modulation parameters are set from Receiver Menu.

### 22. "Freq" Soft Function Key F1

Selects Receiver Frequency or Cellular Channel. See Figure 3-3.

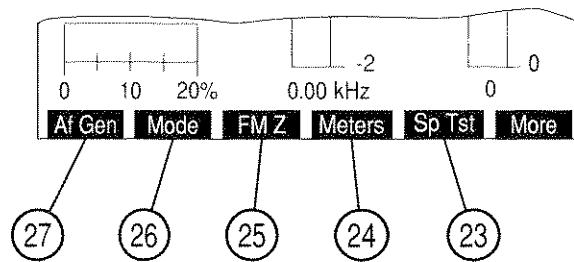

03416008

23. "Sp Tst" Soft Function Key F5

Accesses Dual Mode IS-136 Cellular Menu.

24. "Meters"/"Dist"/"Modul"/"Tune" Soft Function Key F4

- For FM or PM Modulation, "Meters" appears. Pressing F4 displays menu listing available meters. Selects Distortion, SINAD, Deviation (RMS), Phase (RMS) or DMM.
- For AM Modulation, "Modul" or "Dist" appears. Pressing F4 toggles between Modulation and Distortion Meter. DMM meter is also displayed with either selection.
- For BFO Modulation, "Tune" appears. Pressing F4 accesses TUNE and tunes the receiver higher or lower in 125 Hz steps.

25. "FM Z"/"DMM" Soft Function Key F3

- For FM Modulation, "FM Z" appears. Access to zero the Deviation Meter.
- For BFO Modulation, "DMM" appears. Access to display DMM Meter. DMM Meter appears as a digital meter only.

26. "Mode" Soft Function Key F2

Displays menu listing the Receiver Operation Modes. Select Direct (normal operation), Channel, Freq Scan, Freq List or Freq List Scan. If Channel Mode is selected, select Cellular Channel Format using "Chan" Soft Function Key F2 from the Receiver Menu. Freq Scan Mode allows for scanning while in this screen. Independent scan parameters are specified in the Receive Setup Menu. When in Freq List or Freq List Scan Mode, the RF Generator Screen shares a common frequency list (See 3-3-2c.) with screens specified in 3-3-1, 3-3-4 and 3-3-5.



## ITEM

DESCRIPTION

---

27. "Af Gen" Soft Function Key F1

Allows access to Function Generator frequencies and output level.

- Selecting F1 Freq displays a data field allowing the entry of Function Generator #1 Frequency. Range is from 0.0 to 40000.0 Hz.
- Selecting F2 Freq displays a data field allowing the entry of Function Generator #2 Frequency. Range is from 0.0 to 40000.0 Hz.
- Selecting Level displays a data field allowing the entry of Function Generator Output Level. Range is from 0.0000 to 3.1000 V.

**NOTE:** When the AF Gen is in Boost Mode, F2 Freq is inaccessible and the Level Range is from 0.0000 to 4.0000 V.

The following set of Soft Function Keys are accessed when a full size Spectrum Analyzer is displayed.

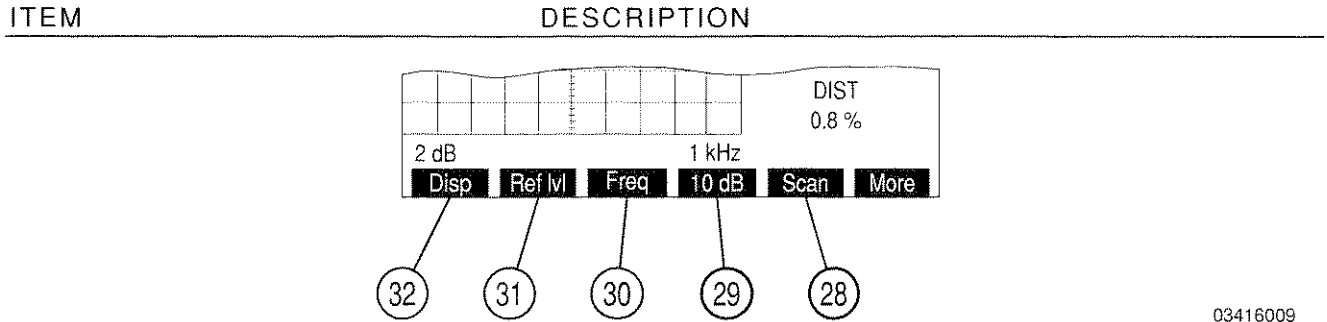

03416009

28. "Scan" Soft Function Key F5

Selects Spectrum Analyzer Scan Width. Selects Zero Scan (0 kHz) or one of the following:

- |         |         |         |
|---------|---------|---------|
| 1 kHz   | 2 kHz   | 5 kHz   |
| 10 kHz  | 20 kHz  | 50 kHz  |
| 100 kHz | 200 kHz | 500 kHz |
| 1 MHz   |         |         |

29. "10 dB"/"2 dB" Soft Function Key F4

Toggles the Units/Division Factor to 2 or 10 dB/div.

30. "Freq" Soft Function Key F3

Selects Receiver Frequency. Range is from 0.2500 to 2010.0000 MHz.

31. "Ref lvl" Soft Function Key F2

Appears when using 2 dB/div scale. Selects the Spectrum Analyzer Reference Level. Range is from +10 to -94 dB.

32. "Disp" Soft Function Key F1

Displays menu listing Oscilloscope and Spectrum Analyzer displays. Select full or 1/4 size displays for Oscilloscope or Spectrum Analyzer. Select Decode to display code being decoded.

ITEM	DESCRIPTION
------	-------------

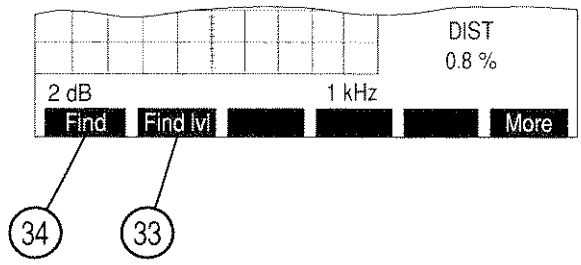

03416010

33. "Find lvl" Soft Function Key F2

Sets Find Reference Level used in the Find Function. When accessed, a red horizontal marker appears displaying the Find Reference Level.

34. "Find" Soft Function Key F1

When activated, finds the first frequency containing a signal with an amplitude greater than the Find Reference Level. Range of the Find Function is 4.0000 to 2010.0000 MHz.

The following set of Soft Function Keys are accessed when an Oscilloscope is displayed:

ITEM	DESCRIPTION
------	-------------

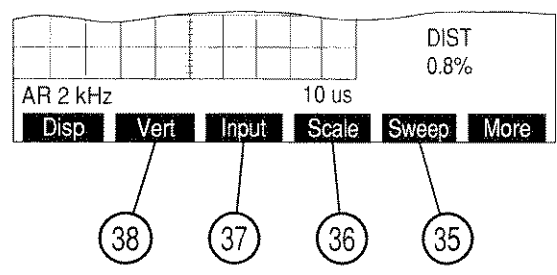

03416011

35. "Sweep" Soft Function Key F5

Selects Oscilloscope Sweep Rate. Appears with full size Oscilloscope except for Rcvr IF Oscilloscope Input. Choose from the following:

- |             |             |             |
|-------------|-------------|-------------|
| 1 $\mu$ s   | 2 $\mu$ s   | 5 $\mu$ s   |
| 10 $\mu$ s  | 20 $\mu$ s  | 50 $\mu$ s  |
| 100 $\mu$ s | 200 $\mu$ s | 500 $\mu$ s |
| 1 ms        | 2 ms        | 5 ms        |
| 10 ms       | 20 ms       | 50 ms       |
| 100 ms      |             |             |

## ITEM

## DESCRIPTION

36. "Scale" Soft Function Key F4

Selects Oscilloscope Scale. Appears with full size Oscilloscope, except when the Oscilloscope Input is SINAD/BER, Rcvr IF, RF Pwr Lvl or Demod Audio (with Receiver Modulation other than FM). For AC, DC or GND Oscilloscope Input, select one of the following:

1 mV/div	2 mV/div	5 mV/div
10 mV/div	20 mV/div	50 mV/div
100 mV/div	200 mV/div	500 mV/div
1 V/div	2 V/div	5 V/div
10 V/div	20 V/div	50 V/div

For Func Gen or Ext Mod Oscilloscope Input, select one of the following:

500 mV/div	1 V/div	2.5 V/div
------------	---------	-----------

For Demod Audio Oscilloscope Input with FM Modulation, select one of the following:

2 kHz/div	4 kHz/div	10 kHz/div
20 kHz/div	Autorange	

Oscilloscope Scale is fixed at 13% MOD and 5 RAD for Oscilloscope Input set to Demod Audio with Modulation set to AM and PM, respectively.

Oscilloscope Scale is blank for Oscilloscope Input set to Demod Audio with Modulation set to OFF or BFO.

Oscilloscope Scale is fixed at 4 V/div and blank for Oscilloscope Input SINAD/BER and Rcvr IF, respectively.

For RF Pwr Lvl Oscilloscope Input, Oscilloscope scale is replaced with 100 mW Rng or 50 W Rng. Power Meter Ranges\* of 20, 50 or 100 mW set Oscilloscope Scale to 100 mW Rng. All other Power Meter Ranges\* set Oscilloscope Scale to 50 W Rng.

\* RF Power Meter works with two primary ranges: 100 mW and 50 W. The field labeled "Range" on the Power Meter Operation screen also represents the current meter scale used within the primary ranges.

37. "Input" Soft Function Key F3

Selects Oscilloscope Input. Choose one of the following:

Rcvr IF	Demod Audio	RF Pwr Lvl
SINAD/BER	Func Gen	Ext Mod
AC	DC	GND

38. "Vert" Soft Function Key F2

Appears with full size Oscilloscope. Adjusts vertical trace position of Oscilloscope. When Oscilloscope Trace is adjusted below Oscilloscope display, an arrow appears on the right bottom edge of the display. When Oscilloscope Trace is adjusted above Oscilloscope display, an arrow appears on the right top edge of the display.

The following set of Soft Function Keys are accessed when Decode Option is selected:

ITEM	DESCRIPTION
------	-------------

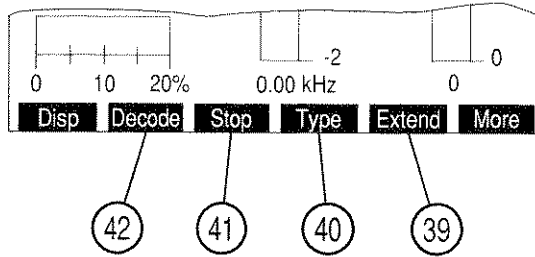

03416012

39. "Extend"/"Input" Soft Function Key F5

Appears except when DTMF is signaling format.

- If DCS or DCS INV is the selected code, "Input" appears. Pressing F5 displays menu listing available Decode Input Sources. Select Demod Audio, SINAD/BER (with Input inverted) or Ext Mod.
- If Audio or POCSAG is the selected code, "Extend" appears. Pressing F5 displays the Extend Screen.

40. "Type" Soft Function Key F4

Appears except when DTMF is signaling format. Selects code to be decoded.

- If Audio is the selected Signaling Format, choose one of the following:

CCIR	EAA	U.S.(EIA)
ZVEI	DDZVEI (ZVEI 2)	DZVEI (ZVEI 3)
NATEL	EURO	5/6 Tone Seq
CCIRH	CCIRH4	User Defined

**NOTE:** RF Generator Audio User Defined Tones are used for decoding.

- If Digital is the selected Signaling Format. Choose one of the following:

DCS	DCS INV	POCSAG
-----	---------	--------

41. "Stop" Soft Function Key F3

Appears when Decode Function is active. Stops the Decode Function.

42. "Decode" Soft Function Key F2

Activates Decode Function. Decode Soft Function Key turns red while decoding.

If Audio is the Signaling Format, the Extend Screen appears as follows:

ITEM	DESCRIPTION
48	Audio Frq
49	Tones Decod. Err %
50	Tones Decod. Dur
51	CCIR #
52	CCIR Frq
47	Input
46	Decode
45	Stop
44	Type
43	Ret

#	Audio Frq	Tones Decod. Err %	Tones Decod. Dur	CCIR #	CCIR Frq	Err %	Dur
1	1158	3.2	98				
2	1167	2.5	99				
3	1298	1.8	101				
4	1406	3.5	98				
5	1475	2.0	98				

03416013

43. "Ret" Soft Function Key F5

Returns to the Receiver Operation Screen.

44. "Type" Soft Function Key F4

Selects the Audio Code to be decoded. Choose one of the following:

CCIR	EEA	U.S.(EIA)
ZVEI	DDZVEI (ZVEI 2)	DZVEI (ZVEI 3)
NATEL	EURO	5/6 Tone Seq
CCIRH	CCIRH4	User Defined

**NOTE:** If User Defined is selected, RF Generator Audio User Defined Tones are used for decoding.

45. "Stop" Soft Function Key F3

Appears when Decode Function is active. Stops the Decode Function.

46. "Decode" Soft Function Key F2

Activates Decode Function. "Decode" appears red when active.

47. "Input" Soft Function Key F1

Displays menu listing available Decode Input Sources. Select Demod Audio, SINAD/BER (with Input inverted) or Ext Mod.

ITEM	DESCRIPTION
------	-------------

- 48. #  
Displays Audio Code Digits received.
- 49. Frq  
Displays received frequency for each Audio Code Digit in Hz.
- 50. Err %  
Displays Frequency Error of received frequency in percentage of ideal Audio Code Digit frequency.
- 51. Dur  
Displays duration of each Audio Code Digit in ms.
- 52. Audio Code  
Selects Audio Code decoded.

If POCSAG is the Signaling Format, the Extend Screen appears as follows:

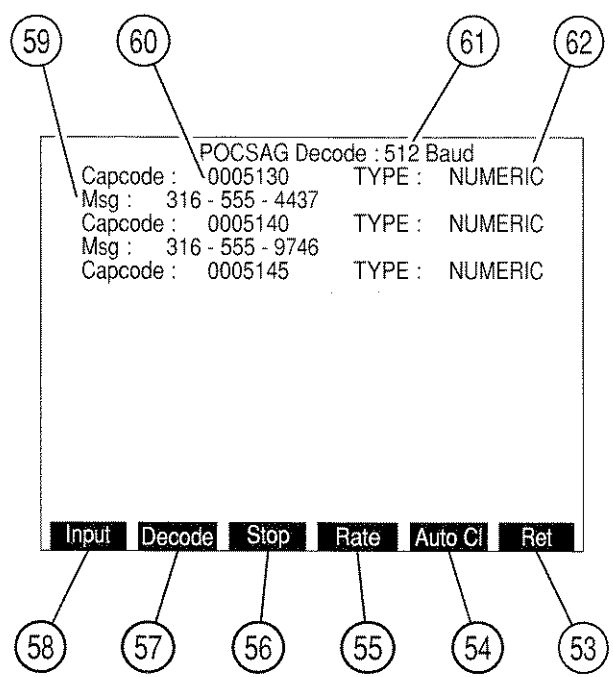

03416014

- 53. "Ret" Soft Function Key F6  
Returns to the Receiver Operation Screen.

ITEM	DESCRIPTION
54. <u>"Auto CI" Soft Function Key F5</u>	Enables/Disables automatic screen clear. If enabled, clears full Extend Screen upon receiving next POCSAG word. If disabled, reception stops when Extend Screen is full. "Auto CI" appears in red when enabled.
55. <u>"Rate" Soft Function Key F4</u>	Selects the POCSAG rate received. Toggles between 512 Baud or 1200 Baud.
56. <u>"Stop" Soft Function Key F3</u>	Appears when Decode Function is active. Stops the Decode Function.
57. <u>"Decode" Soft Function Key F2</u>	Activates Decode Function. "Decode" appears red while decoding.
58. <u>"Input" Soft Function Key F1</u>	Displays menu listing available Decode Input Sources. Select Demod Audio, SINAD/BER (with Input inverted) or Ext Mod.
59. <u>Msg</u>	Displays message received.
60. <u>Capcode</u>	Displays Capcode number received.
61. <u>POCSAG Rate</u>	Displays POCSAG Rate that is decoded. Toggles between 512 Baud and 1200 Baud using "Rate" Soft Function Key F4.
62. <u>POCSAG Function Type</u>	Displays POCSAG Function received.



### C. RECEIVER MENU

When the Receive Operation Screen is displayed, press SETUP Key to access the Receiver Menu. Many Receive Operating Screen Parameters are also edited from the Receiver Menu or one of the submenus.

MENU ITEM	DESCRIPTION
-----------	-------------

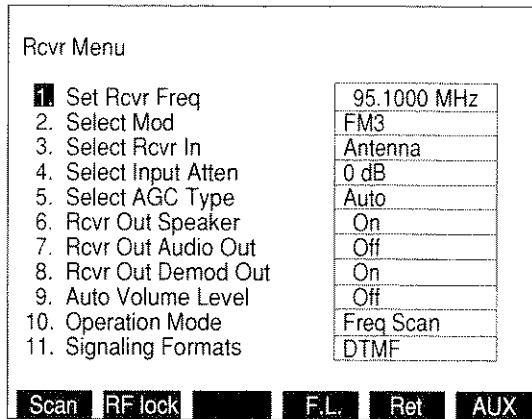

8610345

#### 1. Set Rcvr Freq

Select Receiver Frequency or Cellular Channel. For a Frequency Mode, select 0.2500 to 2010.0000 MHz. For Channel Mode, select 1 to 2047, depending on channel format.

#### 2. Select Mod

Selects Receiver Modulation Type. Select one of the following:

AM1	AM2	FM1
FM2	FM3	FM4
BFO	PM	User Defined

**NOTE:** See Table 3-2 for description of modulation types.

#### 3. Select Rcvr In

Selects Receiver Input Source. Toggles between Antenna (ANTENNA IN) or T/R Connector.

#### 4. Select Input Atten

Selects RF Input Attenuation Level. Select one of the following:

0 dB	5 dB	10 dB
15 dB	20 dB	25 dB
30 dB	LNA*	

\*LNA (Low Noise Amplifier) has the same attenuation as 0 dB, but LNA has a lower noise figure. (**NOTE:** LNA is the preferred option for doing off-the-air applications.)

#### 5. Select AGC Type

Selects AGC Type Menu.

MENU ITEM	DESCRIPTION
6. <u>Rcvr Out Speaker</u>	Sets Receiver Output routing to Speaker. Toggles between on and off.
7. <u>Rcvr Out Audio Out</u>	Sets Receiver Output routing to AUDIO OUT Connector. Toggles between on and off.
8. <u>Rcvr Out Demod Out</u>	Sets Receiver Output routing to DEMOD OUT Connector. Toggles between on and off.
9. <u>Auto Volume Level</u>	Toggles Automatic Volume Level between on or off.
10. <u>Operation Mode</u>	Displays menu listing the Receiver Operation Modes. Allows selection of Direct (normal operation), Channel, Freq Scan, Freq List or Freq List Scan. Freq Scan Mode allows for scanning while in the Receiver Operation Screen. Independent scan parameters are specified in the Stored RF Frequency List, accessible by means of "F.L." Soft Function Key F4. When in Freq List or Freq List Scan Mode, the Receiver Operation Screen shares a common frequency list with the RF Generator, Duplex, Duplex Transmitter and Duplex Receiver Operation Screens.
11. <u>Signaling Formats</u>	Displays menu featuring DTMF, Audio and Digital Functions. Select Format to decode. Selecting Audio displays the Audio Code Menu. Selecting Digital displays the Digital Code Menu.

The following set of Soft Function Keys are available with the Receiver Menu.

ITEM	DESCRIPTION
63.	"AUX"/"ESC" Soft Function Key F6

03416015

63. "AUX"/"ESC" Soft Function Key F6
- "ESC" appears while parameters are accessed for editing. Allows edit procedure to be canceled without changing parameter. "AUX" displays Auxiliary Functions Menu.
64. "Ret" Soft Function Key F5
- Returns operation to Receiver Operation Screen.

ITEM

DESCRIPTION

65. "F.L." Soft Function Key F4

Accesses the Stored RF Frequency List

ITEM

DESCRIPTION

Item	Generate	Receive	Offset	Span
0.	2010.0000	1910.0000	100.0000	On
1.	2000.5000	1900.5000	100.0000	On
2.	1950.7500	1850.7500	100.0000	On
3.	1900.5000	1800.5000	100.0000	On
4.	0.2500	0.2500	0.0000	Off
5.	0.2500	0.2500	0.0000	Off
6.	0.2500	0.2500	0.0000	Off
7.	0.2500	0.2500	0.0000	Off
8.	0.2500	0.2500	0.0000	Off
9.	0.2500	0.2500	0.0000	Off

Pg Up Pg Dn Clear Fill Scan Ret

03416001

1. Item

Identifies each line in the RF Frequency List. There are 100 (0 to 99) lines with 10 on the screen at a time.

2. Generate

The column of frequencies for the RF Generator and Duplex Receiver operations. Use FIELD SELECT Keys (1) to move cursor to an item line in the Generate column and press ENTER Key to activate data field. Use DATA ENTRY Keypad (29) to enter desired frequency and press ENTER Key. Range is 0.2500 to 2010.0000 MHz.

3. Receive

The column of frequencies for the Receiver and Duplex Transmitter operations. Use FIELD SELECT Keys (1) to move cursor to an item line in the Receive column and press ENTER Key to activate data field. Use DATA ENTRY Keypad (29) to enter desired frequency and press ENTER Key. Range is 0.2500 to 2010.0000 MHz.

ITEM	DESCRIPTION
------	-------------

4. Offset

The column which specifies or reflects the difference between Generate and Receive frequency columns. If a value is entered into this column, the value in the Generate column is changed to maintain the difference between Generate and Receiver frequencies specified. The difference between Generate and Receive frequencies is equal to Generate minus Receive. Use FIELD SELECT Keys (1) to move cursor to an item line in the Offset column and press ENTER Key to activate data field. Use DATA ENTRY Keypad (29) to enter desired frequency and press ENTER Key.

5. Scan

Used for Frequency List Scan Mode only. Item lines are skipped during scanning if Scan is turned off. Use FIELD SELECT Keys (1) to move cursor to an item line in the Scan column and press ENTER Key to toggle between On or Off.

The following set of Soft Function Keys are available with the Stored RF Frequency List Screen

ITEM	DESCRIPTION
------	-------------

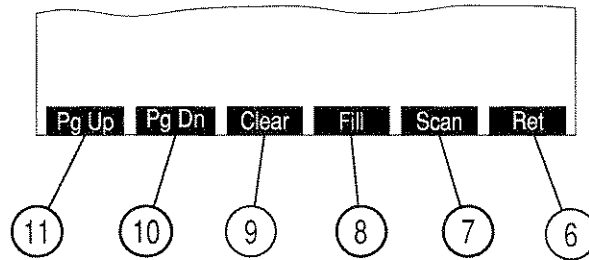

8616019

6. "Ret"/"ESC" Soft Function Key F6

"ESC" appears while parameters are accessed for editing. Allows edit procedure to be canceled without changing parameter. "Ret" returns operation to Receiver Operation Screen.

ITEM	DESCRIPTION
7. <u>"Scan" Soft Function Key F5</u>	<p>Displays the RF Receive Frequency Scan List Menu.</p> <ul style="list-style-type: none"> <li data-bbox="396 348 558 375">● <u>Squelch</u></li> </ul> <p style="margin-left: 40px;">Toggles Squelch between on or off.</p> <ul style="list-style-type: none"> <li data-bbox="396 464 591 491">● <u>Scan Rate</u></li> </ul> <p style="margin-left: 40px;">Selects time period for receiver to sit on a frequency unless squelch is broken. Range is from 0.02 to 99.99 sec.</p> <ul style="list-style-type: none"> <li data-bbox="396 606 613 634">● <u>Pause Time</u></li> </ul> <p style="margin-left: 40px;">Selects time period for receiver to sit on a frequency if squelch is broken. Range is from 0.0 to 99.9 sec. If 0.0 is selected, receiver sits on frequency as long as squelch is broken.</p>
8. <u>"Fill" Soft Function Key F4</u>	<p>Changes all the frequencies below a selected frequency to the value in either the Generate and Receive columns.</p>
9. <u>"Clear" Soft Function Key F3</u>	<p>Returns the selected element of the Generate, Receive, Offset or Scan columns to the default value. Generate and Receive frequencies are returned to 0.2500 MHz. Offset frequencies are returned to zero. Scan is returned to Off.</p>
10. <u>"Pg Dn" Soft Function Key F2</u>	<p>Displays the following page of 10 frequency listings.</p>
11. <u>"Pg Up" Soft Function Key F1</u>	<p>Displays the preceding page of 10 frequency listings.</p>

ITEM	DESCRIPTION
------	-------------

66. "RF lock"/"Chan" Soft Function Key F2

- "RF lock" Soft Function Key F2 activates the RF Lock Function, locking the Receiver RF Frequency to the RF Generator Frequency and the Analyzer RF Frequency. The last frequency entered from among the three frequencies locked is the frequency locked on. The letters "RF lock" appear in red when the RF Lock Function is active.
- "Chan Soft Function Key F2 is displayed for Channel Receiver Operation Mode. Displays Receiver Channel Format Menu.

67. "Scan" Soft Function Key F1

Displays the Receiver RF Frequency Scan Menu.

MENU ITEM	DESCRIPTION
-----------	-------------

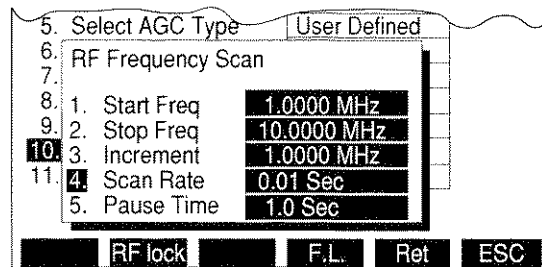

8610346

1. Start Freq

Selects lower limit frequency for scan. Range is from 0.2500 to 2010.0000 MHz.

**NOTE:** Start frequency must be less than Stop frequency for Scan to operate.

2. Stop Freq

Selects upper limit frequency for scan. Range is from 0.2500 to 2010.0000 MHz.

3. Increment

Selects increment between frequencies to be scanned. Range is from 0.0000 to 2010.0000 MHz.

4. Scan Rate

Selects time period for receiver to sit on a frequency unless squelch is broken. Range is from 0.02 to 99.99 sec.

5. Pause Time

Selects time period for receiver to sit on a frequency if squelch is broken. Range is from 0.0 to 99.9 sec. If 0.0 is selected, receiver sits on frequency as long as squelch is broken.

If "2. Select Mod" is selected and "User Defined" is selected as the Modulation Type, the User Defined Modulation Menu appears:

MENU ITEM	DESCRIPTION
-----------	-------------

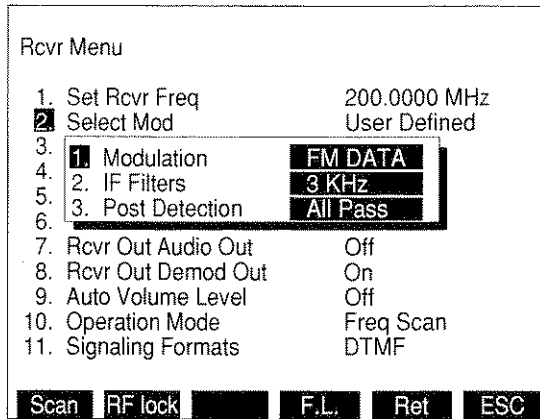

8610347

1. Modulation

Selects User Defined Modulation Type. Choose one of the following:

FM	AM	BFO
PM	FM DATA	

2. IF Filters

Selects User Defined IF Filter. Choose 3, 30 or 300 kHz.

3. Post Detection

Selects Post Detection Filter. Choose All Pass, Low-Pass, High-Pass, Bandpass or C Wt Pass. If Low-Pass, High-Pass and Bandpass are selected, a data field appears to allow the cutoff frequencies to be entered. The ranges of the allowable cutoff frequencies are:

Low-Pass	100 Hz to 30 kHz
High-Pass	500 Hz to 20 kHz
Bandpass low cutoff	500 Hz to 20 kHz
Bandpass high cutoff	100 Hz to 30 kHz

When "5. Select AGC Type" is selected on the Receiver Menu, the following menu appears:

MENU ITEM DESCRIPTION

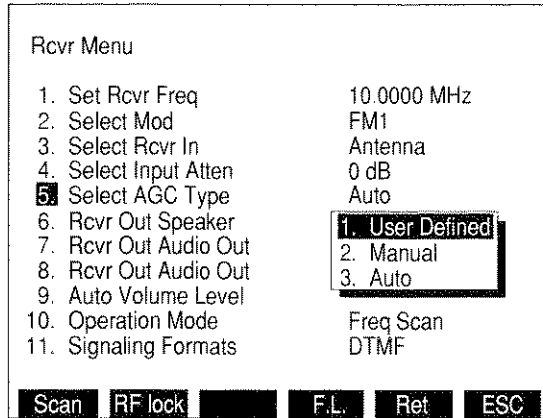

8610348

1. User Defined

Displays User Defined AGC Menu. Table 3-3 list the User Defined AGC Types and their parameters.

AGC TYPE	ATTACK TIME	RELEASE TIME	RECOMMENDED USE
Measurement	500 ms	3 sec	AM signals
Speech	40 ms	3 sec	Off the air monitoring
Data	40 ms	300 ms	Low speed data
High Speed	4 ms	4 ms	High speed data
Type 1	40 ms	40 ms	General purpose as defined by user
Type 2	500 ms	500 ms	General purpose as defined by user
Type 3	3 sec	3 sec	General purpose as defined by user

Table 3-3 User Defined AGC Type Parameters

2. Manual

Selects Receiver AGC Level. Range is 1 to 255. 1 corresponds to minimum IF gain, 255 corresponds to maximum IF gain.

3. Auto

AGC is automatically adjusted.



MENU ITEM

DESCRIPTION

If "10. Operation Mode" is selected, the Receiver Operation Mode Menu appears:

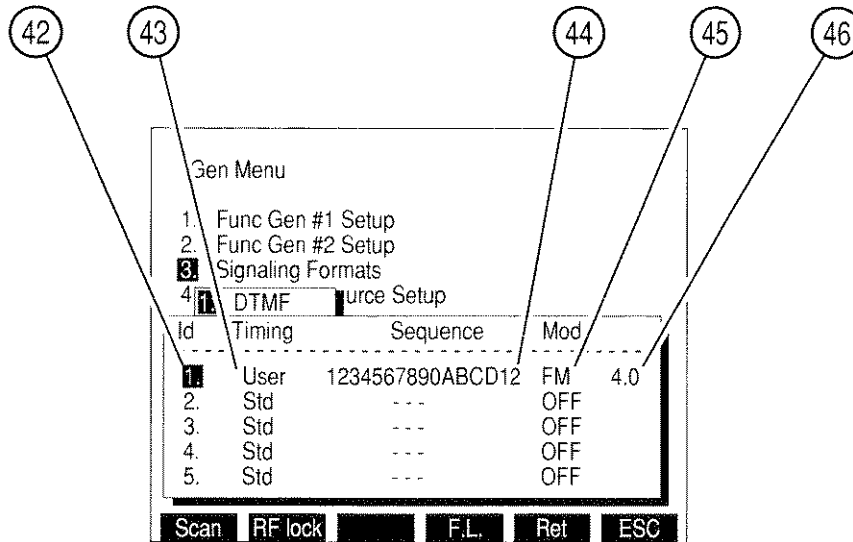

03416002

Selects Receiver Format. Displays Receiver Format Submenu. Allows selection of Direct (normal operation), Channel, Freq Scan, Freq List or Freq List Scan. Freq Scan Mode allows for scanning while in the Receiver Operation Screen. Independent scan parameters are specified in the Stored RF Frequency List, accessible by means of "F.L." Soft Function Key F4. When in Freq List or Freq List Scan Mode, the Receiver Operation Screen shares a common frequency list with the RF Generator, Duplex, Duplex Transmitter and Duplex Receiver Operation Screens.

"Chan" Soft Function Key F2 appears when Channel Mode is selected. When the "Chan" Soft Function Key F2 is selected, the Receiver Channel Format Menu appears listing available Cellular Channel Formats:

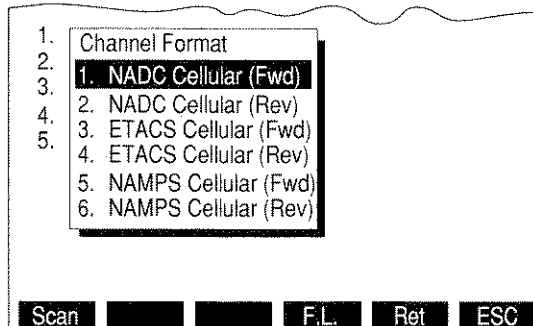

03416004

If an NADC Cellular channel format is selected, the NADC Cellular format menu appears:

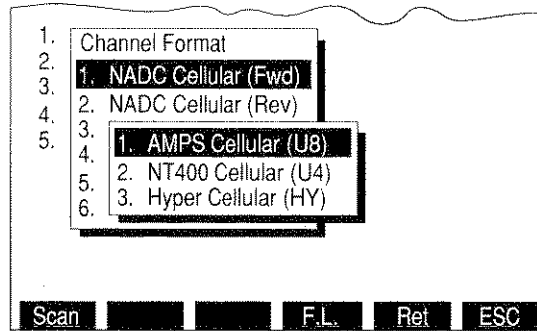

03416005

The operator may select AMPS, NT400<sup>®</sup> or Hyperband channel format.

If "11. Signaling Formats" is selected, the Receiver Signaling Format Menu is displayed. If Audio is selected as the Signaling Format, the Audio Code Menu appears allowing the selection of a Audio Code.

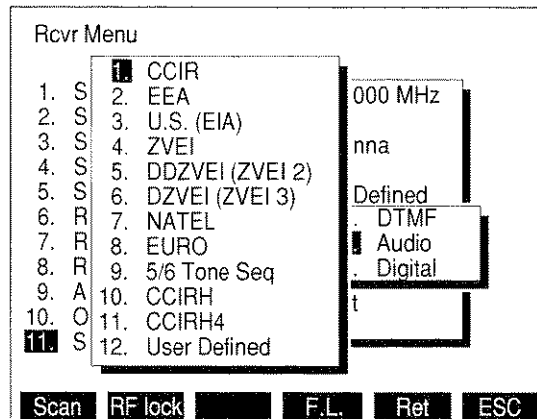

8610349

Selecting User Defined displays menu used to define the desired tones.

ITEM	DESCRIPTION																											
	<p>Rcvr Menu</p> <table border="1"> <thead> <tr> <th>Id</th> <th>Tone(Hz)</th> <th>Duration(ms)</th> </tr> </thead> <tbody> <tr><td>0</td><td>5.0</td><td>20</td></tr> <tr><td>1</td><td>10.0</td><td>20</td></tr> <tr><td>2</td><td>20.0</td><td>20</td></tr> <tr><td>3</td><td>30.0</td><td>20</td></tr> <tr><td>4</td><td>40.0</td><td>20</td></tr> <tr><td>5</td><td>50.0</td><td>20</td></tr> <tr><td>6</td><td>60.0</td><td>20</td></tr> <tr><td>7</td><td>70.0</td><td>20</td></tr> </tbody> </table> <p>Scan RF lock Fill Ref ESC</p>	Id	Tone(Hz)	Duration(ms)	0	5.0	20	1	10.0	20	2	20.0	20	3	30.0	20	4	40.0	20	5	50.0	20	6	60.0	20	7	70.0	20
Id	Tone(Hz)	Duration(ms)																										
0	5.0	20																										
1	10.0	20																										
2	20.0	20																										
3	30.0	20																										
4	40.0	20																										
5	50.0	20																										
6	60.0	20																										
7	70.0	20																										

03416016

68. "Fill" Soft Function Key F4

When a Tone or Duration is highlighted, pressing "Fill" Soft Function Key F4 changes all entries below and in the same column to the value highlighted.

69. Id

Identification Number representing the tone to be defined. Range of characters for the Id is 0 to 9 and A to T. Defining the tone consists of setting the frequency and duration of the tone.

70. Tone(Hz)

Set "Tone(Hz)" to frequency of desired tone. Range is 0.0 to 9999.9 Hz.

71. Duration(ms)

Set "Duration(ms)" to duration of desired tone. Range is 20 to 9999 ms.

If Digital is selected as the Signaling Format, the Digital Code Menu is displayed allowing the selection of a Digital Code.

Rcvr Menu

1. Set Rcvr Freq	10.0000 MHz
2. Select Mod	User Defined
3. Select Rcvr In	Antenna
4. Select Input Atten	0 dB
5. Select AGC Type	Auto
6. Rcvr Out Speaker	On
7. Rcvr Out Audio Out	Off
8. Rcvr Out Demod Out	Off
9. Auto Volume L	1. DCS
10. Operation Mod	2. DCS INV
11. Signaling Form	3. POCSAG

Scan RF lock Ret AUX

8610165

### 3-3-3 DUPLEX OPERATION SCREEN

All features available with the RF Generator and Receiver are available in Duplex Mode as well as the ability to use an offset frequency to test communication equipment capable of generating and receiving simultaneously on different frequencies. While in the Duplex mode, the IFR-1900 utilizes the RF Generator and Receiver as in their individual modes, but features separate screen settings.

Pressing DPLX MODE Key accesses Duplex Operation Screen. The Duplex Transmitter tests Transmitting UUTs and functions as a Receiver. The Duplex Receiver tests receiving UUTs and functions as a RF Generator. The operation of the Duplex Transmitter and Duplex Receiver may be controlled by changing Screen Parameters, using Soft Function Keys or Setup Menus.

The following Screen Parameters portion identifies the operation screen parameters that are edited, the value range available and/or usage of each feature. When editing, use the FIELD SELECT Keys to move the cursor to the parameter to be edited and press the ENTER Key to access the data field. Use the DATA ENTRY Keypad to enter numerical data. Use the DATA SCROLL Spinner or DATA SCROLL ↑ and ↓ Keys to select parameters from a list. Parameters with two settings automatically switch to the opposite setting when selected. To access the Operation Screen of a displayed Meter, move cursor to the Meter and press the ENTER Key.

All available Soft Function Keys are displayed on one screen.

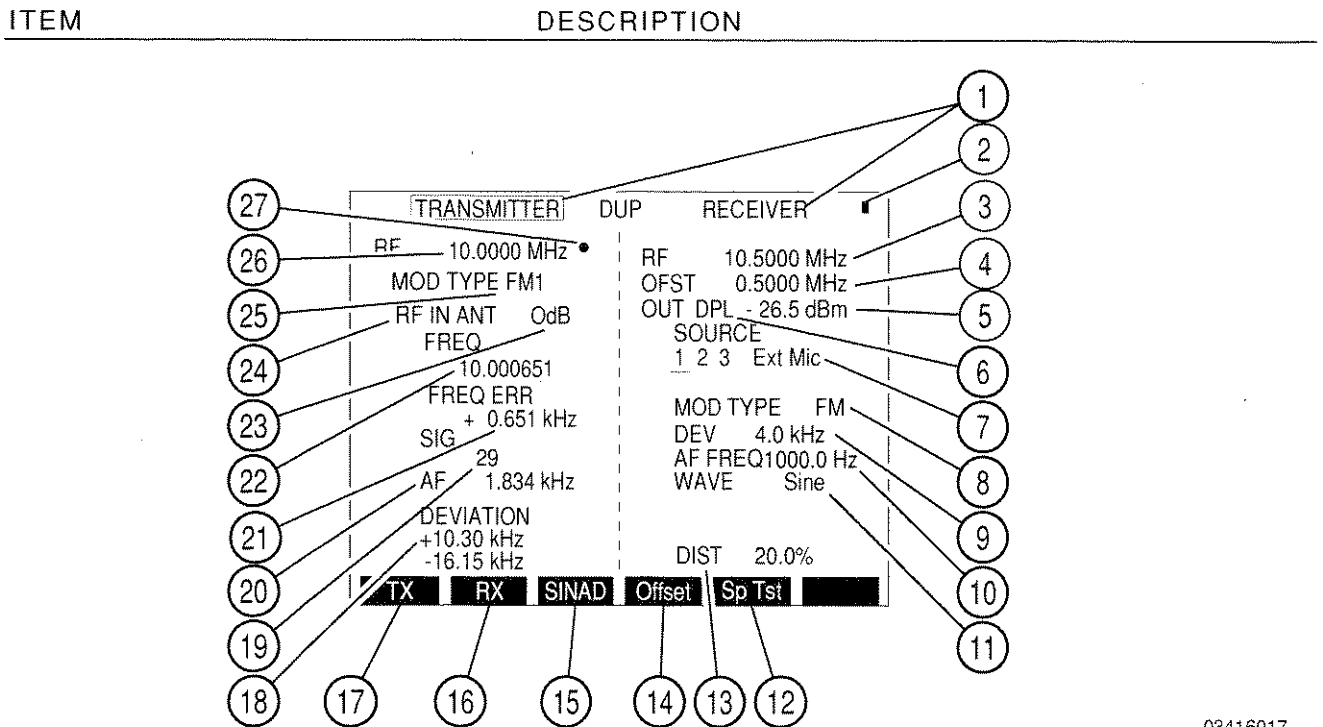

03416017

#### 1. Duplex Screen Labels

With cursor at any left side screen location, press SETUP Key to access Duplex Transmitter Menu. With cursor at any right side screen location, press SETUP Key to access Duplex Receiver Menu.

## ITEM

## DESCRIPTION

2. Scan Mode Indicator

Blue dot appears when Scanning has been activated by either the GO or SGL STEP TEST CONTROL Keys (28). This indicator stays active until the STOP TEST CONTROL (28) Key is pressed or the Duplex Operation Screen is exited. This indicator aids the user in determining when the instrument is scanning and is useful if long pause times or scan rates are in process.

3. Duplex Receiver Frequency/Cellular Channel

Selects frequency or cellular channel of RF signal generated. See Figure 3-3.

Either the Receiver Frequency or the Offset Frequency is the editable frequency at any one time. The parameter that is not editable automatically changes so the Offset Frequency added to the Transmitter Frequency is always equal to the Receiver Frequency.

4. Duplex Offset Frequency

Selects frequency from -1009.7499 to 1009.7499 MHz (when in lower frequency range) or -1000.0000 to 1000.0000 MHz (when in upper frequency range) (**See Note Below**). Either the Receiver Frequency or the Offset Frequency is the editable parameter at any one time. The parameter that is "display-only" automatically changes so that the Offset Frequency added to the Transmitter Frequency is always equal to the Receiver Frequency.

**NOTE:** The Duplex Operation functions within the following two RF ranges:

Lower	0.2500 to 1009.9999 MHz
Upper	1010.0000 to 2010.0000 MHz

The operation of the Duplex Transmitter and Duplex Receiver is limited to one RF range at a time. For example, when entering a valid frequency value in the Duplex Transmitter outside the current range, the frequency value in the Duplex Receiver is automatically forced to the same frequency and vice versa.

5. Duplex Receiver Output Level

Selects Duplex Receiver Output Level. The RF Output range for corresponding output connector and units is as follows:

UNITS	OUTPUT CONNECTOR	
	T/R	DPL (DUPLEX)
dBm	-137.0 to 0.0 dBm	-120.0 to 10.0 dBm
Volts	0.031 $\mu$ V to 0.224 V	0.224 $\mu$ V to 0.707 V

ITEM	DESCRIPTION
6. <u>Duplex Receiver Output Connector</u>	Selects "DPL" (DUPLEX OUT) or "T/R" as the Duplex Receiver Output Connector.
7. <u>Duplex Receiver Source</u>	Underline indicates last selected Source. Selects AM, FM, PM or OFF. <b>NOTE:</b> Except for FM and PM, mixing Modulation types are allowed. Selecting FM for any source changes PM sources to FM. Selecting PM changes FM sources to PM. Sources that are AM or OFF are unaffected.
8. <u>Duplex Receiver Modulation Type</u>	Readout only. Readout indicates the last selected modulation type. Readout shows FM, PM, AM or OFF.
9. <u>Duplex Receiver Modulation Level</u>	Appears only if Modulation is set to FM, PM or AM. Range is from 0.0 to 100.0 kHz for FM, 0.0 to 10.0 radians for PM or 0% to 90% for AM.
10. <u>AF FREQ</u>	Appears when 1 or 2 is the last selected Source. Selects AF frequency. Range is from 0.0 to 40000.0 Hz.
11. <u>WAVE</u>	Appears when 1 or 2 is the last selected Source. Selects Wave Form. Select Sine, Square, Ramp, Triangle, Pulse, +1 Lvl, 0 Lvl or -1 Lvl.
12. <u>"Sp Tst" Soft Function Key F5</u>	Accesses Dual Mode IS-136 Cellular Menu.
13. <u>Distortion/SINAD Meter Readout</u>	Displays Distortion Meter, SINAD Meter or OFF Operation. Definition shown for Soft Function Key F3 is the next selection activated when F3 is pressed. <b>NOTE:</b> SINAD and Distortion Meter measure SINAD/BER IN Connector Input only.
14. <u>"Offset"/"R Freq"/"G Lock" Soft Function Key F4</u>	Selects Offset or Duplex Receiver Frequency as the editable field. "G Lock" appears when both the Duplex Transmitter and Duplex Receiver are in Frequency List Scan operation mode. When "G Lock" is selected, Duplex Transmitter is slaved to Duplex Receiver Scan Rate during Frequency List Scanning. <b>NOTE:</b> "Offset"/"R Freq" are not available in channel mode. <b>NOTE:</b> "G Lock" is not available in Duplex Transmitter Operation Screen (3-3-4), but continues to function if "G Lock" was previously engaged in either Duplex Operation or Duplex Receiver Operation Screen.

ITEM	DESCRIPTION									
15. <u>"Dist"/"SINAD"/"Modul"/"Off" Soft Function Key F3</u>	<p>Selects Distortion, SINAD or Modulation Meter.</p> <p><b>NOTE:</b> Although two Meters may be displayed at one time, only one is active.</p>									
16. <u>"RX" Soft Function Key F2</u>	Displays Duplex Receiver Operation Screen.									
17. <u>"TX" Soft Function Key F1</u>	Displays Duplex Transmitter Operation Screen.									
18. <u>Modulation/Deviation/Phase Meter or TUNE</u>	<ul style="list-style-type: none"> <li>● For AM Modulation, Modulation Meter is displayed. Modulation Meter operation alternates with Distortion and SINAD Meter by pressing Soft Function Key F3.</li> <li>● For FM Modulation, Deviation Meter is displayed.</li> <li>● For PM Modulation, Phase Meter is displayed.</li> <li>● For BFO, TUNE appears. Accessing TUNE allows Receiver tuning in 125 Hz steps using DATA SCROLL ↑ and ↓ Keys.</li> </ul>									
19. <u>Signal Strength Meter or Power Meter</u>	Displays Signal Strength Meter (if ANTENNA IN is selected for Input Connector) or Power Meter (if T/R is selected for Input Connector). Meters are accessed through the Meter Callouts or the Meter Menu.									
20. <u>Duplex Transmitter AF Meter Readout</u>	Displays Audio Frequency received. AF Meter Operation Screen is accessed through the meter callout or the Meter Menu.									
21. <u>Frequency Error Meter</u>	Displays difference between frequency setting and frequency received. Frequency Error Meter Operation Screen is accessed through the meter callout or Meter Menu.									
22. <u>Frequency Meter Display</u>	Displays frequency actually received. Frequency Meter Operation Screen is accessed through the meter callout or the Meter Menu.									
23. <u>Duplex Transmitter Input Attenuation Level</u>	Selects RF Input Attenuation Level. Select one of the following:									
	<table style="margin-left: 40px;"> <tr> <td>0 dB</td> <td>5 dB</td> <td>10 dB</td> </tr> <tr> <td>15 dB</td> <td>20 dB</td> <td>25 dB</td> </tr> <tr> <td>30 dB</td> <td>LNA*</td> <td></td> </tr> </table>	0 dB	5 dB	10 dB	15 dB	20 dB	25 dB	30 dB	LNA*	
0 dB	5 dB	10 dB								
15 dB	20 dB	25 dB								
30 dB	LNA*									
	*LNA (Low Noise Amplifier) has the same attenuation as 0 dB, but LNA has a lower noise figure. ( <b>NOTE:</b> LNA is the preferred option for doing off-the-air applications.)									

ITEM

DESCRIPTION

24. Duplex Transmitter Input Connector

Selects "ANT" (ANTENNA IN) or "T/R" Connector. "ANT" selects the Signal Strength Meter. "T/R" selects the Power Meter.

25. Duplex Transmitter Modulation Type

Select one of the following:

- |     |     |              |
|-----|-----|--------------|
| FM1 | FM2 | FM3          |
| FM4 | AM1 | AM2          |
| BFO | PM  | User Defined |

**NOTE:** See Table 3-2 for description of modulation types.

26. Duplex Transmitter Frequency/Cellular Channel

Selects frequency or cellular channel of RF signal received. See Figure 3-3.

27. 10 MHz External Reference Light

Blue asterisk appears when 10 MHz External Reference Signal is applied to the 10 MHz REFERENCE IN Connector.

If 3 is the last selected Duplex Receiver Source, Operation Screen appears as follows:

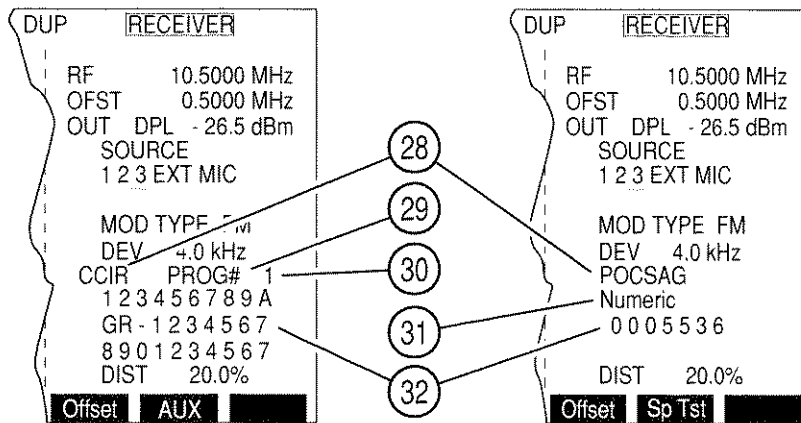

03416018



ITEM	DESCRIPTION
------	-------------

28. Signaling Code Display

- Displays DTMF if DTMF is the selected Signaling Format.
- Accesses Audio Code if Audio Signaling Format is active. Select from:

CCIR	EEA	U.S.(EIA)
ZVEI	DDZVEI(ZVEI 2)	DZVEI (ZVEI 3)
NATEL	EURO	5/6 Tone Seq
CCIRH	CCIRH4	User Defined
- Accesses Digital Code if Digital Signaling Format is active. Select from:

DCS	DCS INV	POCSAG
-----	---------	--------
- Accesses RCC Code if RCC Signaling Format is active. Select from:

IMTS	MTS	2805
Tone Rem		

29. DIRECT ENTRY/PROG #

Accessing callout toggles to the function not shown. Select PROG # to generate a programmed sequence. Select DIRECT ENTRY to allow sequence entry from Operation Screen. Press GO TEST CONTROL Key to generate sequence continuously. Press SGL STEP TEST CONTROL Key to generate sequence once. Press STOP TEST CONTROL Key to stop generating sequence.

30. Program Number

Appears if PROG # is selected. Up to 16 sequences can be programmed.

31. POCSAG or Tone Remote

Accesses POCSAG or Tone Remote Function. For POCSAG, select one of the following:

Tone - 1 beep	Tone - 2 beeps	Tone - 3 beeps
Tone - 4 beeps	Numeric	Numeric seq
Alpha lower	Alpha upper	Alphanumeric
Alpha special		

For Tone Remote, select one of the following:

2050 (Monitor)	1950 (F1)	1850 (F2)
1750 (R2 Mute)	1650 (R2 Unmute)	1550 (Repeater Off)
1450 (Repeater On)	1350 (Wild Card 1 On)	1250 (Wild Card 1 Off)
1150 (Wild Card 2 On)	1050 (Wild Card 2 Off)	

32. Tone Sequence Listing

Displays coded sequence. If DIRECT ENTRY is selected, accessing allows entry of sequence unless POCSAG or Tone Remote are in use.

### 3-3-4 DUPLEX TRANSMITTER OPERATION SCREEN

With the Duplex Operation Screen displayed, press "TX" Soft Function Key F1 to access the Duplex Transmitter Operation Screen. The operation of the Duplex Transmitter may be controlled by changing Screen Parameters, using Soft Function Keys or Setup Menu.

The following Screen Parameters portion identifies the operation screen parameters that are edited, the value range available and/or usage of each feature. When editing, use FIELD SELECT Keys to move the cursor to the parameter to be edited and press ENTER Key to access the data field. Use the DATA ENTRY Keypad to enter numerical data, Use the DATA SCROLL Spinner or DATA SCROLL ↑ and ↓ Keys to select the parameters from a list. Parameters with only two settings automatically toggle to the opposite setting when selected. To access the Operation Screen of a displayed Meter, move cursor to the Meter and press the ENTER Key.

#### A. SCREEN PARAMETERS

ITEM	DESCRIPTION
1	Frequency Meter Display
2	Scan Mode Indicator
3	FREQ ERR
4	SIG
5	DE V
6	TX- [RF] 10.0000 MHz • MOD FM1
7	DIST 14.0%
8	AF 1.783 kHz +10.71 kHz
9	LVL - 20 dBm
10	RF IN ANT 0dB
11	TX- [RF]
12	10.0000 MHz
13	MOD FM1
14	FREQ 10.003813
15	Demod Audio
16	AF 1.783 kHz +10.71 kHz
17	FREQ ERR +3.813 kHz
18	SIG 28

03416019

#### 1. Frequency Meter Display

Displays received Duplex Transmitter Frequency. Frequency Meter Operation Screen is accessed through the Meter Callout or the Meter Menu.

#### 2. Scan Mode Indicator

Blue dot appears when Scanning has been activated by the GO or SGL STEP TEST CONTROL Keys (28). This indicator stays active until the STOP TEST CONTROL Key (28) is pressed or the Duplex Transmitter Screen is exited. This indicator aids the user in determining when the instrument is scanning, and is useful if long pause times or scan rates are in process.

## ITEM

## DESCRIPTION

3. Frequency Error Meter Display

Displays difference between received UUT frequency and Duplex Transmitter Frequency Setting. Frequency Error Meter Operation Screen is accessed through the Meter Callout or the Meter Menu.

4. Signal Strength Meter or Power Meter

Displays Signal Strength Meter (if "ANT" is selected as Duplex Transmitter Input) or Power Meter (if "T/R" is selected as Duplex Transmitter Input). Meter Operation Screens are accessed through Meter Callouts.

5. Deviation Meter/Modulation Meter/Phase Meter

Appears for all modulation types except BFO. Displays Deviation Meter (for FM Modulation), Phase Meter (for PM Modulation) or Modulation Meter (for AM Modulation).

6. Soft Function Keys

Duplex Transmitter Soft Function Keys are covered in 3-3-4B.

7. Selected Meter/TUNE Adjustment

- For AM Modulation, select Distortion or Modulation Meter using Soft Function Key F4.
- For FM or PM Modulation, select Distortion, SINAD, Deviation (RMS) or Phase (RMS) Meter using "Meters" Soft Function Key F4.
- For BFO Modulation, the TUNE Adjustment Callout is displayed allowing adjustment in 125 Hz steps using the DATA SCROLL ↑ and ↓ Keys.

8. Signaling Format, Oscilloscope or Spectrum Analyzer

Displays Decode, Oscilloscope or Spectrum Analyzer operation. When full size display, Distortion/SINAD, Deviation/Modulation and Signal Strength/Power Meters display as digital readouts. Selected using "Disp" Soft Function Key F1.

9. Duplex Receiver Output Level

Displayed in top right corner of screen when Oscilloscope or Analyzer are shown full size. The Duplex Receiver Output range for corresponding output connector and units is as follows:

UNITS	OUTPUT CONNECTOR	
	T/R	DPL (DUPLEX)
dBm	-137.0 to 0.0 dBm	-120.0 to 10.0 dBm
Volts	0.031 $\mu$ V to 0.224 V	0.224 $\mu$ V to 0.707 V

ITEM	DESCRIPTION
------	-------------

10. Duplex Transmitter Input Attenuation

Selects RF Input Attenuation Level. Select one of the following:

0 dB	5 dB	10 dB
15 dB	20 dB	25 dB
30 dB	LNA*	

\*LNA (Low Noise Amplifier) has the same attenuation as 0 dB, but LNA has a lower noise figure. (**NOTE:** LNA is the preferred option for doing off-the-air applications.)

11. Duplex Transmitter Input Connector

Selects "ANT" (ANTENNA IN) or "T/R" Connector for Duplex Transmitter Input Connector.

12. Duplex Transmitter Operation Screen Callout

Label used for screen identification. Not an editable parameter.

13. Squelch Indicator Light

Green dot appears when squelch is broken,

14. Duplex Transmitter Frequency/Cellular Channel

Selects frequency or cellular channel of RF signal received. See Figure 3-3.

**NOTE:** The Duplex Operation functions within the following two RF ranges:

Lower	0.2500 to 1009.9999 MHz
Upper	1010.0000 to 2010.0000 MHz

The operation of the Duplex Transmitter and Duplex Receiver is limited to one RF range at a time. For example, when entering a valid frequency value in the Duplex Transmitter outside the current range, the frequency value in the Duplex Receiver is automatically forced to the same frequency and vice versa.

15. 10 MHz External Reference Light

Blue asterisk appears when 10 MHz External Reference Signal is applied to the 10 MHz REFERENCE IN Connector.

16. Oscilloscope Input

Appears with Oscilloscope. Select Receive IF, Demod Audio, RF Power Input, SINAD/BER, Function Generator, External Audio, AC, DC or GND.

ITEM	DESCRIPTION
------	-------------

---

17. Duplex Transmitter Modulation Type

Select one of the following:

- |     |     |              |
|-----|-----|--------------|
| FM1 | FM2 | FM3          |
| FM4 | AM1 | AM2          |
| BFO | PM  | User Defined |

**NOTE:** See Table 3-2 for description of modulation types. User Defined parameters are set from Duplex Transmitter Menu.

18. Audio Frequency Meter

Displays Audio Frequency received. AF Meter Operation Screen is accessed through the Meter Callout or through the Meter Menu.

## B. SOFT FUNCTION KEYS

The following index lists the Soft Function Keys available for the Duplex Transmitter Operation Screen:

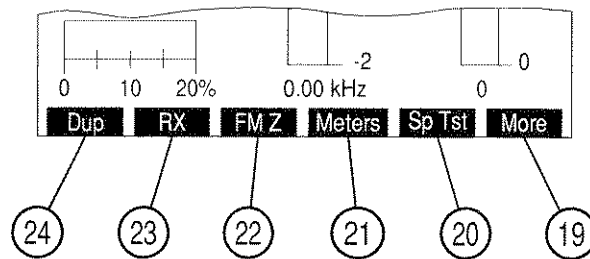

03416020

ITEM	DESCRIPTION
19.	<u>"More"/"ESC" Soft Function Key F6</u>  "ESC" appears while parameters are accessed for editing. Allows edit procedure to be canceled without changing parameter. "More" displays additional sets of Soft Function Keys.
20.	<u>"Sp Tst" Soft Function Key F5</u>  Displays the Dual Mode IS-136 Cellular Menu.
21.	<u>"Meters"/"Dist"/"Modul"/"Tune" Soft Function Key F4</u> <ul style="list-style-type: none"><li>● For AM Modulation, select Distortion or Modulation Meter. Pressing F4 toggles which meter is displayed.</li><li>● For FM or PM Modulation, displays submenu allowing the selection of the Distortion, SINAD, Deviation (RMS) or Phase (RMS) Meter.</li><li>● For BFO Modulation, selects the TUNE Adjustment Callout allowing adjustment in 125 Hz steps using the DATA SCROLL ↑ and ↓ Keys.</li></ul>
22.	<u>"FM Z" Soft Function Key F3</u>  Appears with FM Modulation. Zeroes Deviation Meter.
23.	<u>"RX" Soft Function Key F2</u>  Displays Duplex Receiver Operation Screen.
24.	<u>"Dup"/"AGC" Soft Function Key F1</u>  "AGC" Soft Function Key F5 appears for manual AGC. Allows adjustment of Receiver AGC Level from the Receiver Operation Screen. When AGC is not set to manual, "Dup" Soft Function Key F5 appears. Displays Duplex Operation Screen.

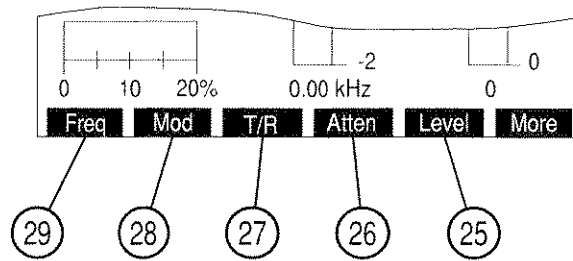

03416021

25. "Level" Soft Function Key F5

Selects Duplex Receiver Output Level. The Duplex Receiver Output range for corresponding output connector and units is as follows:

UNITS	OUTPUT CONNECTOR	
	T/R	DPL (DUPLEX)
dBm	-137.0 to 0.0 dBm	-120.0 to 10.0 dBm
Volts	0.031 $\mu$ V to 0.224 V	0.224 $\mu$ V to 0.707 V

26. "Atten" Soft Function Key F4

Selects RF Input Attenuation Level. Select one of the following:

0 dB	5 dB	10 dB
15 dB	20 dB	25 dB
30 dB	LNA*	

\*LNA (Low Noise Amplifier) has the same attenuation as 0 dB, but LNA has a lower noise figure. (**NOTE:** LNA is the preferred option for doing off-the-air applications.)

27. "T/R" or "Ant" Soft Function Key F3

Toggles Duplex Transmitter Input Connector between T/R and ANTENNA IN Connector.

28. "Mod" Soft Function Key F2

Selects Duplex Transmitter Modulation Type. Select one of the following:

FM1	FM2	FM3
FM4	AM1	AM2
BFO	PM	User Defined

**NOTE:** See Table 3-2 for description of modulation types.

29. "Freq" Soft Function Key F1

Selects Duplex Transmitter Frequency or Cellular Channel. See Figure 3-3.

The following Soft Function Keys appear when full size Spectrum Analyzer is displayed:

ITEM	DESCRIPTION
------	-------------

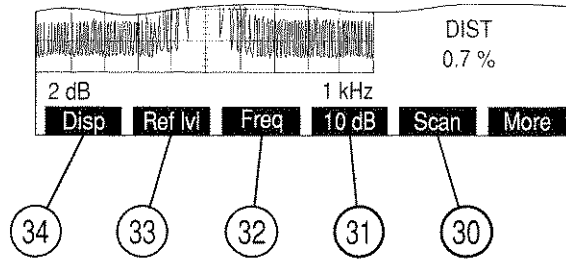

03416022

30. "Scan" Soft Function Key F5

Appears with full size Spectrum Analyzer. Selects Spectrum Analyzer Scan Width. Select from Zero Scan (0 kHz) or:

- |         |         |         |
|---------|---------|---------|
| 1 kHz   | 2 kHz   | 5 kHz   |
| 10 kHz  | 20 kHz  | 50 kHz  |
| 100 kHz | 200 kHz | 500 kHz |
| 1 MHz   |         |         |

31. "10 dB/2 dB" Soft Function Key F4

Appears with full size Spectrum Analyzer. Toggles Units/Division Factor between 10 and 2 dB/div.

32. "Freq" Soft Function Key F3

Selects Duplex Transmitter Frequency or Cellular Channel. See Figure 3-3.

33. "Ref lvl" Soft Function Key F2

Appears with full size Spectrum Analyzer with 2 dB vertical scale. Adjusts vertical grid position of the Spectrum Analyzer Trace.

34. "Disp" Soft Function Key F1

Submenu appears listing Oscilloscope, Spectrum Analyzer and Decode displays. Select desired display using DATA ENTRY Keypad.



ITEM

DESCRIPTION

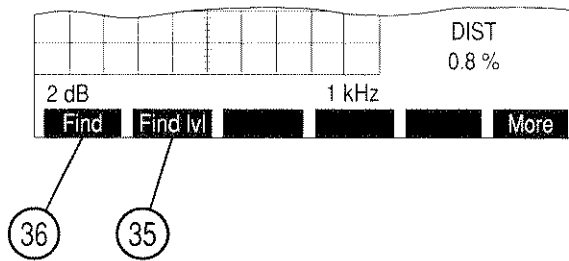

03416023

35. "Find lvl" Soft Function Key F2

Sets Find Reference Level used in the Find Function. When accessed, a red horizontal marker appears displaying the Find Reference Level.

36. "Find" Soft Function Key F1

Finds the first frequency containing a signal with an amplitude greater than the Find Reference Level. Range of the frequencies is 4.0000 to 2010.0000 MHz.

The following set of Soft Function Keys appear when the Oscilloscope is displayed:

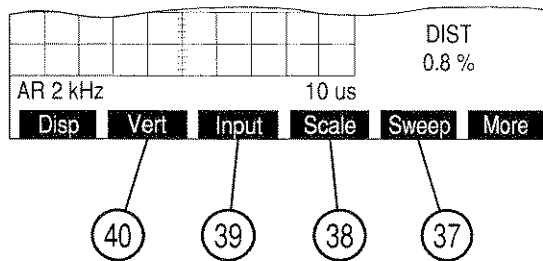

03416024

37. "Sweep" Soft Function Key F5

Appears with full size Oscilloscope, except when "Rcvr IF" is the Oscilloscope Input. Select one of the following:

- |             |             |             |
|-------------|-------------|-------------|
| 1 $\mu$ s   | 2 $\mu$ s   | 5 $\mu$ s   |
| 10 $\mu$ s  | 20 $\mu$ s  | 50 $\mu$ s  |
| 100 $\mu$ s | 200 $\mu$ s | 500 $\mu$ s |
| 1 ms        | 2 ms        | 5 ms        |
| 10 ms       | 20 ms       | 50 ms       |
| 100 ms      |             |             |

## ITEM

## DESCRIPTION

38. "Scale" Soft Function Key F4

Selects Oscilloscope Scale. Appears with full size Oscilloscope, except when the Oscilloscope Input is SINAD/BER, Rcvr IF, RF Pwr Lvl or Demod Audio (with Receiver Modulation other than FM). For AC, DC or GND Oscilloscope Input, select one of the following:

1 mV/div	2 mV/div	5 mV/div
10 mV/div	20 mV/div	50 mV/div
100 mV/div	200 mV/div	500 mV/div
1 V/div	2 V/div	5 V/div
10 V/div	20 V/div	50 V/div

For Func Gen or Ext Mod Oscilloscope Input, select one of the following:

500 mV/div	1 V/div	2.5 V/div
------------	---------	-----------

For Demod Audio Oscilloscope Input with FM Modulation, select one of the following:

2 kHz/div	4 kHz/div	10 kHz/div
20 kHz/div	Autorange	

Oscilloscope Scale is fixed at 13% MOD and 5 RAD for Oscilloscope Input set to Demod Audio with Modulation set to AM and PM, respectively.

Oscilloscope Scale is blank for Oscilloscope Input set to Demod Audio with Modulation set to OFF or BFO.

Oscilloscope Scale is fixed at 4 V/div and blank for Oscilloscope Input SINAD/BER and Rcvr IF, respectively.

For RF Pwr Lvl Oscilloscope Input, Oscilloscope scale is replaced with 100 mW Rng or 50 W Rng. Power Meter Ranges\* of 20, 50 or 100 mW set Oscilloscope Scale to 100 mW Rng. All other Power Meter Ranges\* set Oscilloscope Scale to 50 W Rng.

\* RF Power Meter works with two primary ranges: 100 mW and 50 W. The field labeled "Range" on the Power Meter Operation screen also represents the current meter scale used within the primary ranges.

39. "Input" Soft Function Key F3

Selects Oscilloscope Input. Select one of the following:

Rcvr IF	Demod Audio	RF Pwr Lvl
SINAD/BER	Func Gen	Ext Mod
AC	DC	GND

40. "Vert" Soft Function Key F2

Appears with full size Oscilloscope. Adjusts vertical Trace position of oscilloscope. When Oscilloscope Trace is adjusted below Oscilloscope display, an arrow appears on the right bottom edge of the display. When Oscilloscope Trace is adjusted above Oscilloscope display, an arrow appears on the right top edge of the display.

The following set of Soft Function Keys are accessed when the Decode is selected using "Disp" Soft Function Key F1.

ITEM	DESCRIPTION
------	-------------

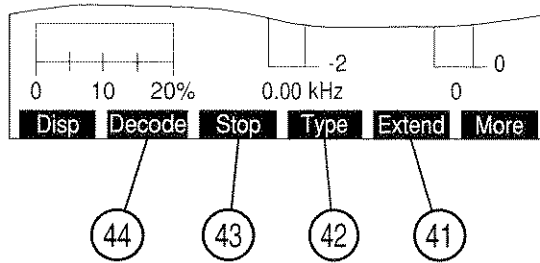

03416025

41. "Extend"/"Input" Soft Function Key F5

Appears except when DTMF is signaling code.

- If DCS or DCS INV is the selected code, "Input" appears. Pressing F5 displays menu listing available Decode Input Sources. Select Demod Audio, SINAD/BER (with Input inverted) or Ext Mod.
- If Audio or POCSAG is the selected code, "Extend" appears. Pressing F5 displays the Extend Screen.

42. "Type" Soft Function Key F4

Appears except when DTMF is signaling code. Selects code to be decoded.

- If Audio is the selected Signaling Format, choose one of the following:

CCIR	EEA	U.S.(EIA)
ZVEI	DDZVEI (ZVEI 2)	DZVEI (ZVEI 3)
NATEL	EURO	5/6 Tone Seq
CCIRH	CCIRH4	User Defined

- If Digital is the selected Signaling Format, choose one of the following:

DCS	DCS INV	POCSAG
-----	---------	--------

43. "Stop" Soft Function Key F3

Appears when Decode Function is active. Stops the Decode Function.

44. "Decode" Soft Function Key F2

Activates Decode Function. Decode appears in red while decoding.

If Audio is the Signaling Format, the Extend Screen appears as follows:

ITEM	DESCRIPTION
50	#
51	Audio Frq
52	Tones Decod. Err % Dur
53	CCIR #
54	CCIR Frq Err % Dur
49	Input
48	Decode
47	Stop
46	Type
45	Ret

#	Audio Frq	Tones Decod. Err %	Dur	CCIR #	CCIR Frq	CCIR Err %	CCIR Dur
1	1158	3.2	98				
2	1167	2.5	99				
3	1298	1.8	101				
4	1406	3.5	98				
5	1475	2.0	98				

03416026

45. "Ret" Soft Function Key F5

Returns to the Duplex Transmitter Operation Screen.

46. "Type" Soft Function Key F4

Selects the Audio code to be decoded. Choose one of the following:

- |       |                 |                |
|-------|-----------------|----------------|
| CCIR  | EEA             | U.S.(EIA)      |
| ZVEI  | DDZVEI (ZVEI 2) | DZVEI (ZVEI 3) |
| NATEL | EURO            | 5/6 Tone Seq   |
| CCIRH | CCIRH4          | User Defined   |

47. "Stop" Soft Function Key F3

Appears when Decode Function is active. Stops the Decode Function.

48. "Decode" Soft Function Key F2

Activates Decode Function. "Decode" appears red while decoding.

49. "Input" Soft Function Key F1

Displays menu listing available Decode Input Sources. Select Demod Audio, SINAD/BER (with Input inverted) or Ext Mod.

50. #

Displays Audio Code Digits received.

ITEM	DESCRIPTION
51. <u>Frg</u>	Displays received frequency for each Audio Code Digit in Hz.
52. <u>Err %</u>	Displays Frequency Error of received frequency in percentage of ideal Audio Code Digit frequency.
53. <u>Dur</u>	Displays duration of each Audio Code Digit in ms.
54. <u>Audio Code Type</u>	Displays the Audio Code decoded.

If POCSAG is the Signaling Format, the Extend Screen appears as follows:

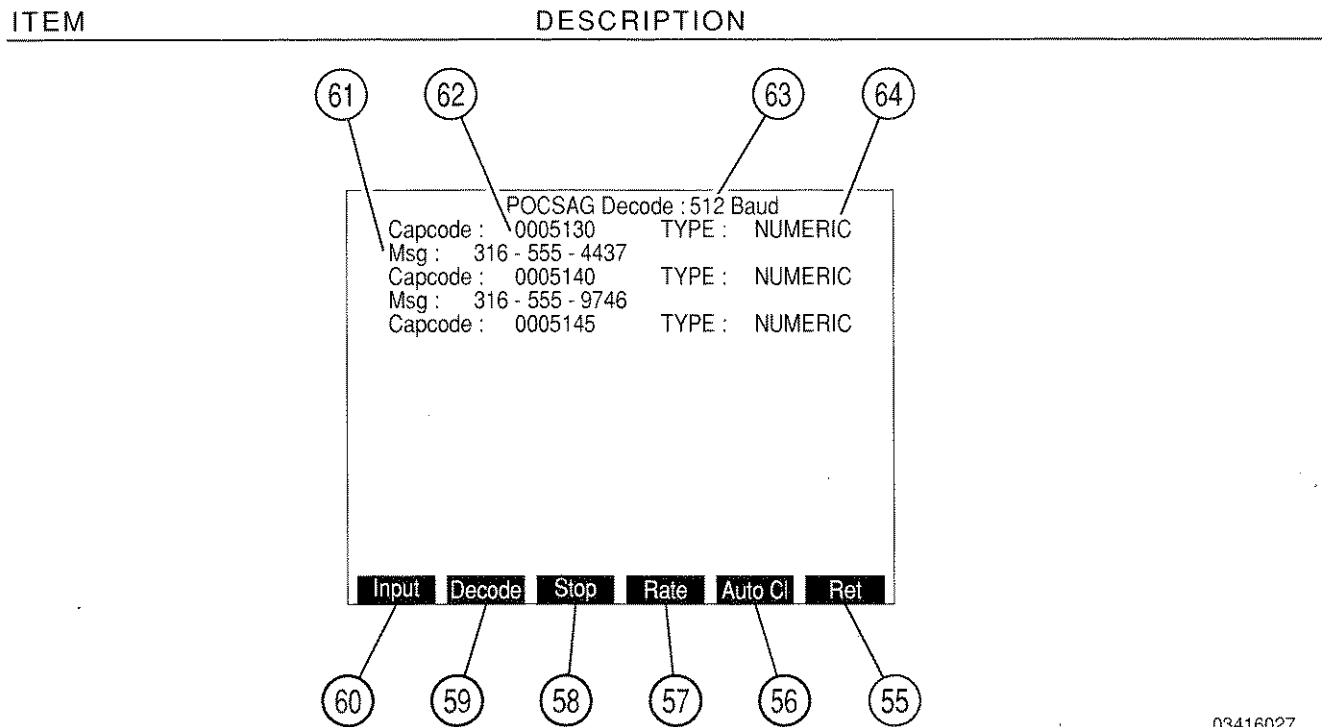

03416027

55. "Ret" Soft Function Key F6  
Returns to the Duplex Transmitter Operation Screen.
56. "Auto Cl" Soft Function Key F5  
Enables/Disables automatic screen clear. If enabled, clears full Extend Screen upon receiving next POCSAG word. If disabled, reception stops when Extend Screen is full. "Auto Cl" appears in red when enabled.

ITEM	DESCRIPTION
57. <u>"Rate" Soft Function Key F4</u>	Selects the POCSAG rate received. Toggles between 512 Baud or 1200 Baud.
58. <u>"Stop" Soft Function Key F3</u>	Appears when Decode Function is active. Stops the Decode Function.
59. <u>"Decode" Soft Function Key F2</u>	Activates Decode Function. "Decode" appears red while decoding.
60. <u>"Input" Soft Function Key F1</u>	Displays menu listing available Decode Input Sources. Select Demod Audio, SINAD/BER (with Input inverted) or Ext Mod.
61. <u>Msg</u>	Displays message received.
62. <u>Capcode</u>	Displays Capcode number received.
63. <u>POCSAG Rate</u>	Displays POCSAG Rate decoded. Toggles between 512 Baud and 1200 Baud using "Rate" Soft Function Key F4.
64. <u>POCSAG Function Type</u>	Displays POCSAG Function received.

### C. DUPLEX TRANSMITTER MENU

When the Duplex Transmitter Operation Screen is displayed, press the SETUP Key to access the Duplex Transmitter Menu:

MENU ITEM DESCRIPTION

Duplex Transmitter Menu	
1. Set Rcvr Freq	95.1000 MHz
2. Select Mod	FM3
3. Select Rcvr In	Antenna
4. Select Input Atten	0 dB
5. Select AGC Type	Auto
6. Rcvr Out Speaker	On
7. Rcvr Out Audio Out	Off
8. Rcvr Out Demod Out	On
9. Auto Volume Level	Off
10. Operation Mode	Direct
11. Signaling Formats	DTMF

Scan F.L. Ret AUX

8610350

#### 1. Set Rcvr Freq

Selects Duplex Transmitter Frequency or Cellular Channel. For a Frequency Mode, select 0.2500 to 2010.0000 MHz. For Channel Mode, select 1 to 2047, depending on channel format.

#### 2. Select Mod

Selects Duplex Transmitter Modulation Type. Select one of the following:

FM1	FM2	FM3
FM4	AM1	AM2
BFO	PM	User Defined

**NOTE:** See Table 3-2 for description of modulation types.

#### 3. Select Rcvr In

Selects Duplex Transmitter Input Connector. Select "Antenna" or "T/R."

#### 4. Select Input Atten

Selects RF Input Attenuation Level. Select one of the following:

0 dB	5 dB	10 dB
15 dB	20 dB	25 dB
30 dB	LNA*	

\*LNA (Low Noise Amplifier) has the same attenuation as 0 dB, but LNA has a lower noise figure. (**NOTE:** LNA is the preferred option for doing off-the-air applications.)

#### 5. Select AGC Type

Displays "Select AGC Type" Menu.

MENU ITEM	DESCRIPTION
6. <u>Rcvr Out Speaker</u>	Sets Duplex Transmitter Output routing to Speaker. Toggles between On or Off.
7. <u>Rcvr Out Audio Out</u>	Sets Duplex Transmitter Output routing to AUDIO OUT Connector. Toggles between On or Off.
8. <u>Rcvr Out Demod Out</u>	Sets Duplex Transmitter Output routing to DEMOD OUT Connector. Toggles between On or Off.
9. <u>Auto Volume Level</u>	Toggles Automatic Volume Level between On or Off.
10. <u>Operation Mode</u>	Displays menu listing the Duplex Transmitter Operation Modes. Select Direct (normal operation), Channel, Freq Scan, Freq List or Freq List Scan. If Channel Mode is selected, select Cellular Channel Format using "Chan" Soft Function Key F2 from the Duplex Transmitter Menu. Freq Scan Mode allows for scanning while in this screen. Independent scan parameters are specified in the Receive Setup Menu. When in Freq List or Freq List Scan Mode, the RF Generator Screen shares a common frequency list (See 3-3-2c.) with screens specified in 3-3-1, 3-3-4 and 3-3-5.
11. <u>Signaling Formats</u>	Displays menu featuring DTMF, Audio and Digital Functions. Selects Format to decode. Selecting Audio displays the Audio Signaling Menu. Selecting Digital displays the Digital Code Menu.

The following set of Soft Function Keys are available with the Duplex Transmitter Menu.

ITEM	DESCRIPTION

03416028

65. "AUX"/"ESC" Soft Function Key F6
- "ESC" appears while parameters are accessed for editing. Allows edit procedure to be canceled without changing parameter. "AUX" displays Auxiliary Functions Menu.



## ITEM

## DESCRIPTION

66. "Ret" Soft Function Key F5

Returns operation to Duplex Transmitter Operation Screen.

67. "F.L." Soft Function Key F4

Accesses the Stored RF Frequency List.

## ITEM

## DESCRIPTION

Item	Generate	Receive	Offset	Scan
0.	2010.0000	1910.0000	100.0000	On
1.	2000.5000	1900.5000	100.0000	On
2.	1950.7500	1850.7500	100.0000	On
3.	1900.5000	1800.5000	100.0000	On
4.	0.2500	0.2500	0.0000	Off
5.	0.2500	0.2500	0.0000	Off
6.	0.2500	0.2500	0.0000	Off
7.	0.2500	0.2500	0.0000	Off
8.	0.2500	0.2500	0.0000	Off
9.	0.2500	0.2500	0.0000	Off

Pg Up | Pg Dn | Clear | Fill | Scan | Ret

03416001

1. Item

Identifies each line in the RF Frequency List. There are 100 (0 to 99) lines with 10 in view on the screen at a time.

2. Generate

The column of frequencies for the RF Generator and Duplex Receiver operations. Use FIELD SELECT Keys (1) to move cursor to an item line in the Generate column and press ENTER Key to activate data field. Use DATA ENTRY Keypad (29) to enter desired frequency and press ENTER Key.

3. Receive

The column of frequencies for the Receiver and Duplex Transmitter operations. Use FIELD SELECT Keys (1) to move cursor to an item line in the Receive column and press ENTER Key to activate data field. Use DATA ENTRY Keypad (29) to enter desired frequency and press ENTER Key.

4. Offset

The column which specifies or reflects the difference between Generate and Receive frequency columns. If a value is entered into this column, the value in the Generate column is changed to maintain the difference between Generate and Receiver frequencies specified. The difference between Generate and Receive frequencies is equal to Generate minus Receive. Use FIELD SELECT Keys (1) to move cursor to an item line in the Offset column and press ENTER Key to activate data field. Use DATA ENTRY Keypad (29) to enter desired frequency and press ENTER Key.

5. Scan

Used for Frequency List Scan Mode only. Item lines is skipped during scanning if Scan is turned Off. Use FIELD SELECT Keys (1) to move cursor to an item line in the Scan column and press ENTER Key to toggle between On or Off.

68. "Scan" Soft Function Key F1

Displays RF Frequency Scan Menu.

● Start Freq

Selects lower limit frequency for scan. Range is from 0.2500 to 2010.0000 MHz.

**NOTE:** Start frequency must be less than Stop frequency for Scan to operate.

● Stop Freq

Selects upper limit frequency for scan. Range is from 0.2500 to 2010.0000 MHz.

● Increment

Selects increment between frequencies to be scanned. Range is from 0.0000 to 2010.0000 MHz.

● Scan Rate

Selects time period for Duplex Transmitter to sit on a frequency unless squelch is broken. Range is from 0.02 to 99.99 sec.

● Pause Time

Selects time period for Duplex Transmitter to sit on a frequency if squelch is broken. Range is from 0.0 to 99.9 sec. If 0.0 is selected, Duplex Transmitter sits on frequency as long as squelch is broken.

The following set of Soft Function Keys are available with the Stored RF Frequency List Screen.

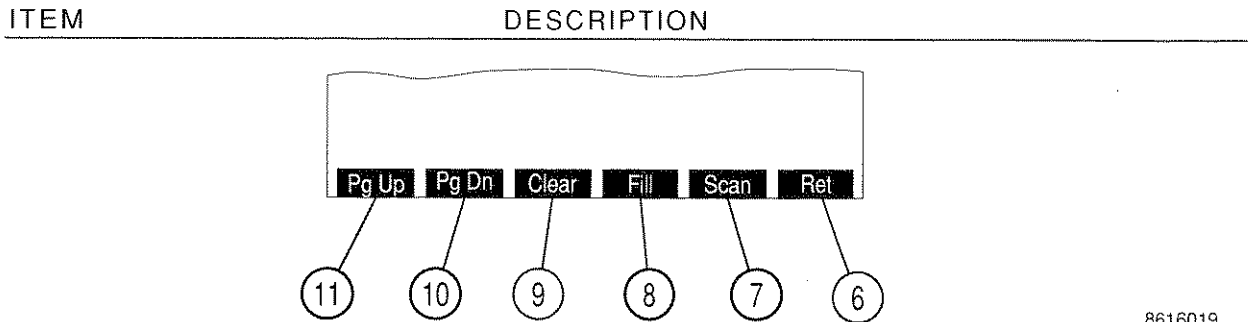

8616019

6. "Ret"/"ESC" Soft Function Key F6

"ESC" appears while parameters are accessed for editing. Allows edit procedure to be canceled without changing parameter. "Ret" returns operation to Duplex Transmitter Operation Screen.

7. "Scan" Soft Function Key F5

Displays the RF Receive Frequency Scan List Menu

● Squelch

Toggles Squelch between On or Off.

● Scan Rate

Selects time period for Duplex Transmitter (receiver) to sit on a frequency unless squelch is broken. Range is from 0.02 to 99.99 sec.

● Pause Time

Selects time period for Duplex Transmitter (receiver) to sit on a frequency if squelch is broken. Range is from 0.0 to 99.9 sec. If 0.0 is selected, receiver sits on frequency as long as squelch is broken.

8. "Fill" Soft Function Key F4

Changes all the frequencies below a selected frequency to the value in the Generate and Receive columns.

9. "Clear" Soft Function Key F3

Returns the selected element of the Generate, Receive, Offset, or Scan columns to its default value. Generate and Receive frequencies are returned to 0.2500 MHz. Offset frequencies are returned to zero. Scan is returned to Off.

10. "Pg Dn" Soft Function Key F2

Displays the following page of 10 frequency listings.

ITEM	DESCRIPTION
------	-------------

11. "Pg Up" Soft Function Key F1

Displays the preceding page of 10 frequency listings.

If "2. Select Mod" is selected and "11. User Defined" is selected as the Modulation Type, the User Defined Modulation Menu appears:

MENU ITEM	DESCRIPTION
-----------	-------------

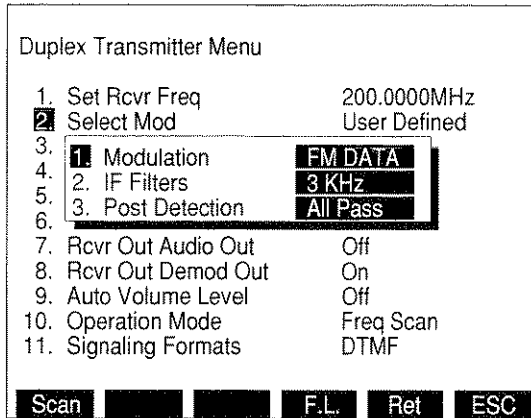

8610351

1. Modulation

Selects User Defined Modulation Type. Select one of the following:

FM	AM	BFO
PM	FM DATA	

2. IF Filters

Selects User Defined IF Filter. Select 3, 30 or 300 kHz.

3. Post Detection

Selects Post Detection Filter. Select All Pass, Low-Pass, High-Pass, Bandpass or C Wt Pass. When Low-Pass, High-Pass and Bandpass are selected, a data field appears to allow the cutoff frequencies to be entered. The ranges of the allowable cutoff frequencies are:

Low-Pass	100 Hz to 30 kHz
High-Pass	500 Hz to 20 kHz
Bandpass low cutoff	500 Hz to 20 kHz
Bandpass high cutoff	100 Hz to 30 kHz

When "5. Select AGC Type" is selected on the Duplex Transmitter Menu, the following Menu appears:

MENU ITEM

DESCRIPTION

MENU ITEM	DESCRIPTION
Duplex Transmitter Menu	
1. Set Rcvr Freq	10.0000 MHz
2. Select Mod	FM1
3. Select Rcvr In	Antenna
4. Select Input Atten	0 dB
5. Select AGC Type	Auto
6. Rcvr Out Speaker	1. User Defined
7. Rcvr Out Audio Out	2. Manual
8. Rcvr Out Audio Out	3. Auto
9. Auto Volume Level	
10. Operation Mode	Freq Scan
11. Signaling Formats	DTMF
Scan	
	F.L.
	Ret
	ESC

8610352

1. User Defined

Displays User Defined AGC Menu. Select Measurement, Speech, Data, High Speed, Type 1, Type 2 or Type 3. See Table 3-3 for description of User Defined AGC Types.

2. Manual

Selects Duplex Transmitter AGC Level. Range is from 1 to 255. 1 corresponds to minimum IF gain, 255 corresponds to maximum IF gain.

3. Auto

AGC is automatically adjusted.

MENU ITEM

DESCRIPTION

If "10. Operation Mode" is selected, the Duplex Transmitter Operation Mode Menu appears:

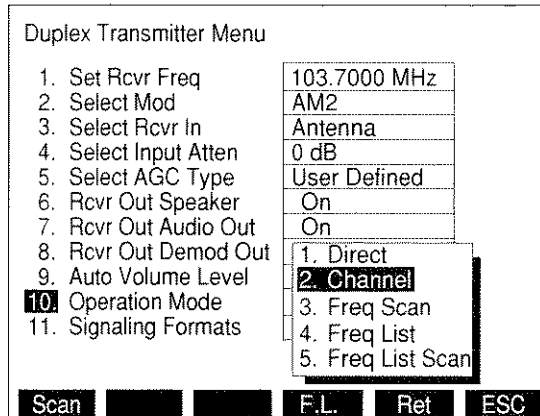

8610331

Selects Duplex Transmitter Format. Displays Operation Mode Submenu. Allows selection of Direct (normal operation), Channel, Freq Scan, Freq List or Freq List Scan. Freq Scan Mode allows for scanning while in the Duplex Transmitter Operation Screen. Independent scan parameters are specified in the Stored RF Frequency List, accessible by means of "F.L." Soft Function Key F4. When in Freq List or Freq List Scan Mode, the Duplex Transmitter Operation Screen shares a common frequency list with the RF Generator, Receiver, Duplex and Duplex Receiver Operation Screens.

"Chan" Soft Function Key F2 appears when Channel Mode is selected. When the "Chan" Soft Function Key F2 is selected, the Duplex Transmitter Channel Format Menu appears listing available Cellular Channel Formats:

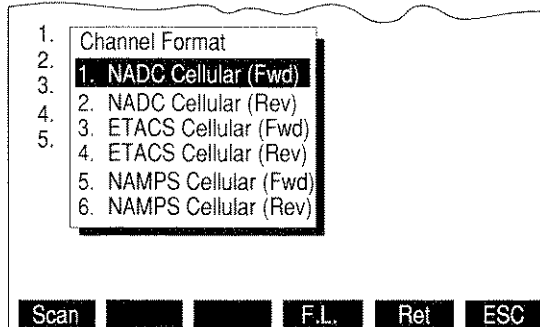

03416004

If an NADC Cellular channel format is selected, the NADC Cellular format menu appears:

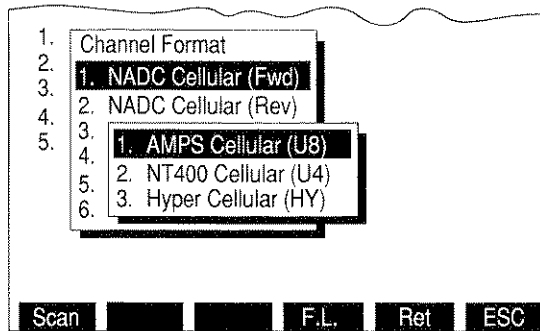

03416005

The operator may select AMPS, NT400© or Hyperband channel format.

If "11. Signaling Formats" is selected, the Duplex Transmitter Signaling Format Menu is displayed. If Audio is selected as the Signaling Format, the Audio Code Menu appears allowing selection of an Audio Code:

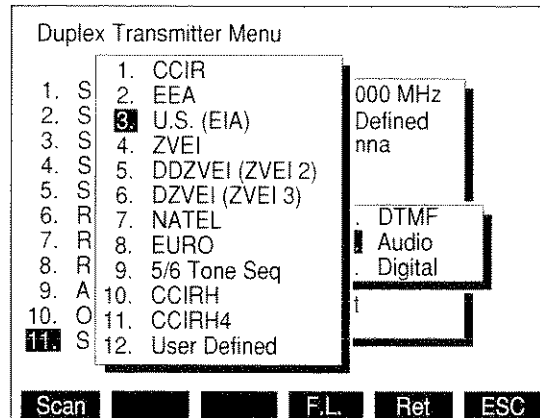

8610353

Selecting User Defined displays menu used to define the desired tones.

ITEM DESCRIPTION

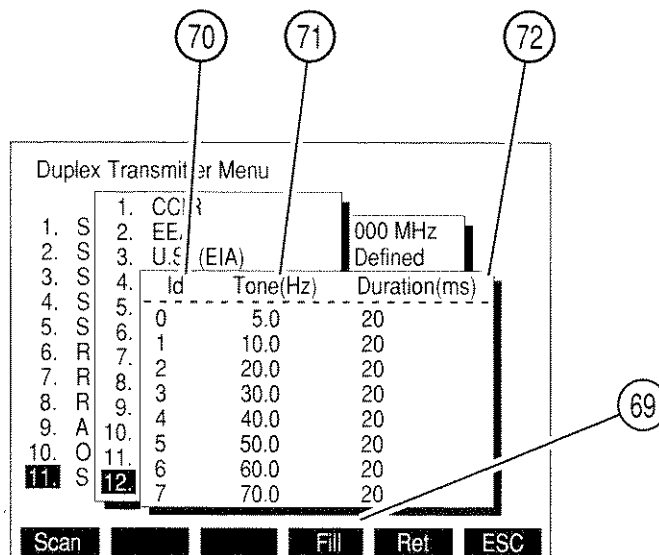

03416029

69. "Fill" Soft Function Key F4

When a Tone or Duration is highlighted, pressing "Fill" Soft Function Key F4 changes all entries below and in the same column to the value highlighted.

70. Id

Identification Number representing the tone to be defined. Range of characters for the Id is 0 to 9 and A to T. Defining the tone consists of setting the frequency and duration of the tone.

71. Tone(Hz)

Set "Tone(Hz)" to frequency of desired tone. Range is 0.0 to 9999.9 Hz.

ITEM

DESCRIPTION

72. Duration(ms)

Set "Duration(ms)" to duration of desired tone. Range is 20 to 9999 ms.

If Digital is selected as the Signaling Format, the Digital Code Menu appears allowing the selection of a Digital Code:

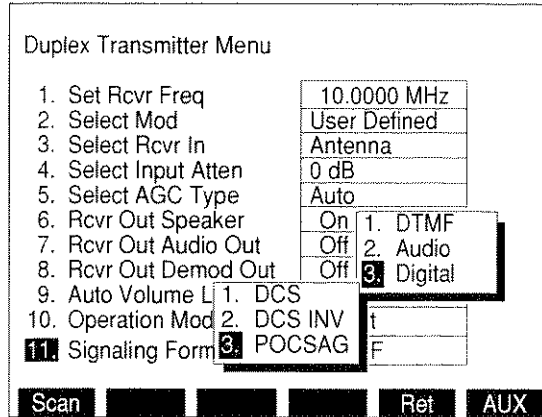

8610354



### 3-3-5 DUPLEX RECEIVER OPERATION SCREEN

With the Duplex Operation Screen displayed, press "RX" Soft Function Key F2 to access the Duplex Receiver Operation Screen. The operation of the Duplex Receiver may be controlled by changing Screen Parameters, using Soft Function Keys or Setup Menu.

The following Screen Parameters portion identifies the operation screen parameters that are edited, the value range available and/or usage of each feature. When editing, use FIELD SELECT Keys to move the cursor to the parameter to be edited and press ENTER Key to access the data field. Use the DATA ENTRY Keypad to enter numerical data, Use the DATA SCROLL Spinner or DATA SCROLL ↑ and ↓ Keys to select the parameters from a list. Parameters with only two settings automatically toggle to the opposite setting when selected. To access the Operation Screen of a displayed Meter, move cursor to the Meter and press the ENTER Key.

#### A. SCREEN PARAMETERS

ITEM DESCRIPTION

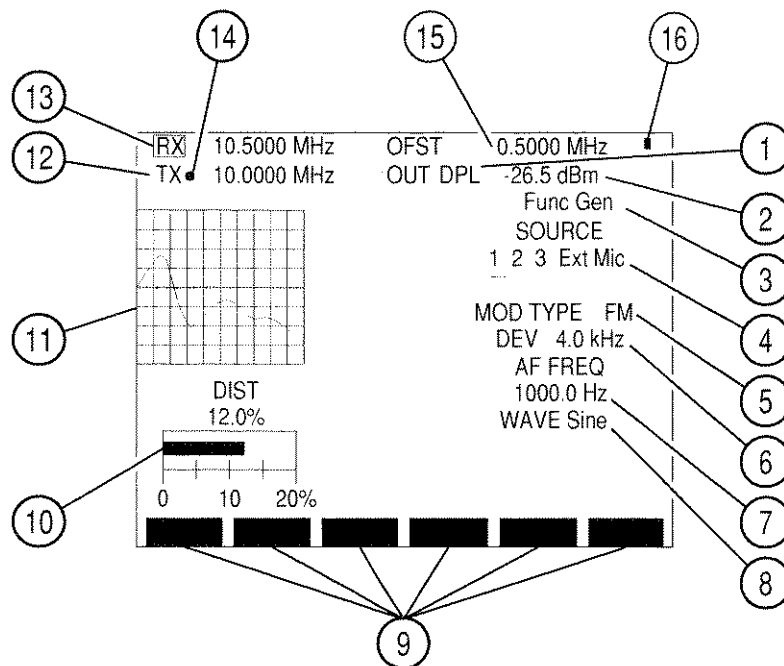

03416030

#### 1. Duplex Receiver Output Connector

Select "DPL" (DUPLEX OUT) or "T/R" Connector for Duplex Receiver Output.

#### 2. Duplex Receiver Output Level

The Duplex Receiver Output range for corresponding output connector and units is as follows:

UNITS	OUTPUT CONNECTOR	
	T/R	DPL (DUPLEX)
dBm	-137.0 to 0.0 dBm	-120.0 to 10.0 dBm
Volts	0.031 μV to 0.224 V	0.224 μV to 0.707 V

ITEM	DESCRIPTION							
3. <u>Oscilloscope Input</u>	Appears with Oscilloscope. Select SINAD/BER, Func Gen, Ext Mod, AC, DC or GND.							
4. <u>Duplex Receiver Modulation Source</u>	Underline indicates last selected Modulation Source. Select AM, FM, PM or OFF. <b>NOTE:</b> Except for FM and PM, mixing Modulation types are allowed. Selecting FM for any source changes PM sources to FM. Selecting PM changes FM sources to PM. Sources that are AM or OFF are unaffected. Source 2 and 3 can be active simultaneously, except when Source 3 is generating an Audio Signaling Code.							
5. <u>Duplex Receiver Modulation Type</u>	Readout only. Readout indicates last selected Source Modulation Type.							
6. <u>Duplex Receiver Modulation Level</u>	Appears if a source is active. Range is 0.0 to 100.0 kHz for FM Modulation, 0% to 90% for AM Modulation or 0.0 to 10.0 radians for PM Modulation. <b>NOTE:</b> When Ext Source is selected, Modulation Level setting assumes the modulating signal applied to the EXT MOD IN Connector is 3.54 VRMS. Modulation Level setting is set higher for lower EXT MOD IN Connector input voltages to achieve the same modulation level as per the following equation:							
	<table style="margin-left: auto; margin-right: auto;"> <tr> <td style="text-align: center;">Modulation Level setting (kHz, %, rad)</td> <td style="text-align: center;">×</td> <td style="text-align: center;">EXT MOD IN Connector Input (VRMS)</td> <td style="text-align: center;">÷</td> <td style="text-align: center;">3.54</td> <td style="text-align: center;">=</td> <td style="text-align: center;">Actual Modulation Level</td> </tr> </table>	Modulation Level setting (kHz, %, rad)	×	EXT MOD IN Connector Input (VRMS)	÷	3.54	=	Actual Modulation Level
Modulation Level setting (kHz, %, rad)	×	EXT MOD IN Connector Input (VRMS)	÷	3.54	=	Actual Modulation Level		
7. <u>AF FREQ</u>	Appears if 1 or 2 is the last selected Source. Selects Audio frequency for last selected Source. Range is 0.0 to 40000.0 Hz.							
8. <u>Duplex Receiver Wave Form</u>	Appears if 1 or 2 is the last selected Source. Select Sine, Square, Ramp, Triangle, Pulse, +1 Lvl, 0 Lvl or -1 Lvl.							
9. <u>Soft Function Keys</u>	Soft Function Keys for Duplex Receiver Operation Screen are covered in 3-3-5B.							
10. <u>Distortion/SINAD/AF LVL/DMM Meter</u>	Displays selected meter. Meter is selected using "Meters" Soft Function Key F4. Meters can be accessed through display or through the Meter Menu. Meter displayed as a digital readout if Oscilloscope or Spectrum Analyzer is full size. <b>NOTE:</b> SINAD, Distortion and AF Level Meters measure only SINAD/BER IN Connector Input. DMM measures only DMM Connectors Input.							

## ITEM

## DESCRIPTION

11. Oscilloscope or Spectrum Analyzer

Displays Oscilloscope or Spectrum Analyzer Operation. Use "Disp" Soft Function Key to display full size or 1/4 size Oscilloscope, full size or 1/4 size Spectrum Analyzer or set to None for no display.

12. Duplex Transmitter Frequency/Cellular Channel

Selects frequency or cellular channel of RF signal received. See Figure 3-3.

13. Duplex Receiver Frequency/Cellular Channel

Selects frequency or cellular channel of RF signal generated. See Figure 3-3.

Either the Duplex Receiver Frequency or the Offset Frequency is the editable frequency at any one time. The parameter that is not editable automatically changes so the Offset Frequency added to the Transmitter Frequency is equal to the Duplex Receiver Frequency.

**NOTE:** If the Offset Frequency is the editable frequency (RX is red) and Channel Mode is selected from the Duplex Receiver menu, the Duplex Receiver channel becomes editable.

14. Squelch Indicator Light

Green dot appears when squelch is broken.

15. Duplex Offset Frequency

Range is from -1009.7499 to 1009.7499 MHz (when in lower frequency range) or -1000.0000 to 1000.0000 MHz (when in upper frequency range) (**See Note Below**). Either the Duplex Receiver Frequency or the Offset Frequency is the editable parameter or "display-only" parameter at any one time. The parameter that is "display-only" automatically changes so that the Offset Frequency added to the Duplex Transmitter Frequency is always equal to the Duplex Receiver Frequency.

**NOTE:** The Duplex Operation functions within the following two RF ranges:

Lower	0.2500 to 1009.9999 MHz
Upper	1010.0000 to 2010.0000 MHz

The operation of the Duplex Transmitter and Duplex Receiver is limited to one RF range at a time. For example, when entering a valid frequency value in the Duplex Transmitter outside the current range, the frequency value in the Duplex Receiver is automatically forced to the same frequency and vice versa.

ITEM

DESCRIPTION

---

16. Scan Mode Indicator

Blue dot appears when Scanning has been activated by either the GO or SGL STEP TEST CONTROL Keys (28). This indicator stays active until either the STOP TEST CONTROL Key (28) is pressed or the Duplex Receiver Screen is exited. This indicator aids the user in determining when the instrument is scanning, and is useful if long pause times or scan rates are in process.

If 3 (Signaling Format) is selected as the Active Source, the Operation Screen appears as follows:

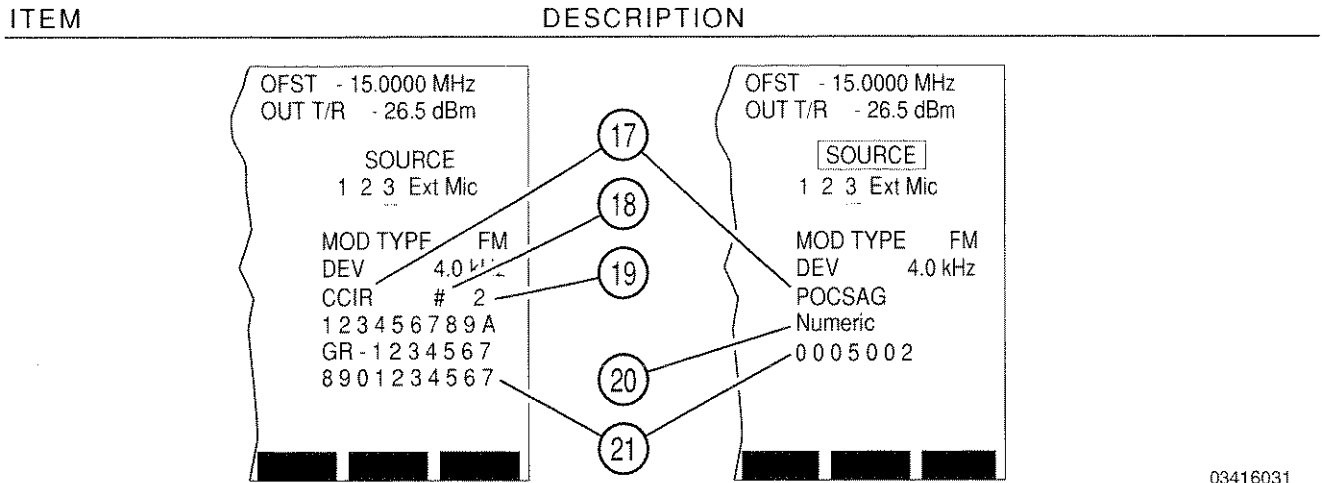

03416031

17. Signaling Code Display

- Displays DTMF if DTMF is the selected Signaling Format.
- Accesses Audio Code if Audio Signaling Format is active. Select from:
 

CCIR	EEA	U.S.(EIA)
ZVEI	DDZVEI (ZVEI 2)	DZVEI (ZVEI 3)
NATEL	EURO	5/6 Tone Seq
CCIRH	CCIRH4	User Defined
- Accesses Digital Code if Digital Signaling Format is active. Select from:
 

DCS	DCS INV	POCSAG
-----	---------	--------
- Accesses RCC Code if RCC Signaling Format is active. Select from:
 

IMTS	MTS	2805
Tone Rem		

18. # (PROGRAM #)/DIR (DIRECT ENTRY)

Accessing Callout toggles it to the function not shown. Select # (Program #) to generate a programmed sequence. Select DIR (Direct Entry) to allow sequence entry from the Operation Screen. Press GO TEST CONTROL Key to transmit sequence.

**NOTE:** When DTMF is Signaling Format, "#" becomes "PROGRAM #" and "DIR" becomes "DIRECT ENTRY."

19. Program Number

Appear except when DIRECT ENTRY is active. Up to 16 sequences can be programmed at a time.

## ITEM

DESCRIPTION

---

20. POCSAG or Tone Remote

Accesses POCSAG or Tone Remote Function. For POCSAG, select one of the following:

Tone - 1 beep  
Tone - 4 beep  
Alpha lower  
Alpha special

Tone - 2 beep  
Numeric  
Alpha upper

Tone - 3 beep  
Numeric seq  
Alphanumeric

For Tone Remote, select one of the following:

2050 (Monitor)  
1750 (R2 Mute)  
1450 (Repeater On)  
1150 (Wild Card 2 On)

1950 (F1)  
1650 (R2 Unmute)  
1350 (Wild Card 1 On)  
1050 (Wild Card 2 Off)

1850 (F2)  
1550 (Repeater Off)  
1250 (Wild Card 1 Off)

21. Tone Sequence Listing

Displays coded sequence. If DIRECT ENTRY is selected, accessing allows entry of sequence unless POCSAG or Tone Remote are in use.

## B. SOFT FUNCTION KEYS

The following index lists the sets of Soft Function Keys available for the Duplex Receiver Operation Screen. Whichever list is accessed last is the list that comes up first when the Duplex Receiver Operation Screen is next accessed.

ITEM	DESCRIPTION
------	-------------

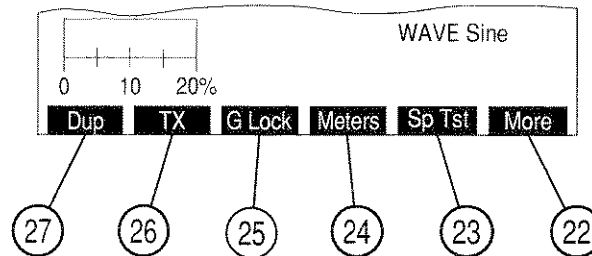

03416032

### 22. "More"/"ESC" Soft Function Key F6

"ESC" appears while parameters are accessed for editing. Allows edit procedure to be canceled without changing parameter. "More" displays additional sets of Soft Function Keys.

### 23. "Sp Tst" Soft Function Key F5

Displays Dual Mode IS-136 Cellular Menu.

### 24. "Meters" Soft Function Key F4

Displays menu listing available Meters. Select SINAD, DIST (Distortion), AF LVL or DMM.

**NOTE:** SINAD and Distortion Meters measure only SINAD/BER IN Connector Input. DMM measures only DMM Connector Input.

### 25. "G Lock" Soft Function Key F3

"G Lock" appears when both the Duplex Transmitter and Duplex Receiver are in Frequency List Scan operation mode. When "G Lock" is selected, Duplex Transmitter is slaved to Duplex Receiver Scan Rate during Frequency List Scanning.

**NOTE:** "G Lock" is not available in Duplex Transmitter Operation Screen (3-3-4), but continues to function if "G Lock" was previously engaged in either Duplex Operation or Duplex Receiver Operation Screen.

### 26. "TX" Soft Function Key F2

Displays Duplex Transmitter Operation Screen.

### 27. "Dup" Soft Function Key F1

Displays Duplex Operation Screen.

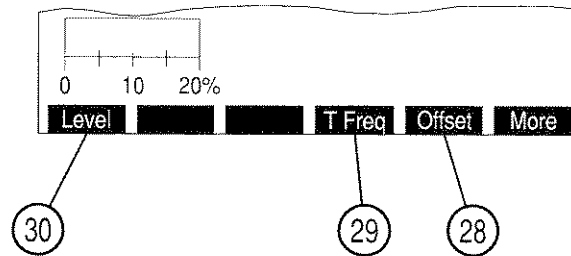

03416033

28. "Offset"/"R Freq" Soft Function Key F5

Toggles which frequency is editable (Offset or Duplex Receiver).

29. "T Freq" Soft Function Key F4

Selects Duplex Transmitter Frequency or cellular channel of RF signal received. For a Frequency Mode, select 0.2500 to 2010.0000 MHz. For a Channel Mode, select 1 to 2047, depending on channel format.

30. "Level" Soft Function Key F1

Selects Duplex Receiver Output Level. The Duplex Receiver Output range for corresponding output connector and units is as follows:

UNITS	OUTPUT CONNECTOR	
	T/R	DPL (DUPLEX)
dBm	-137.0 to 0.0 dBm	-120.0 to 7.0 dBm
Volts	0.031 $\mu$ V to 0.224 V	0.224 $\mu$ V to 0.707 V

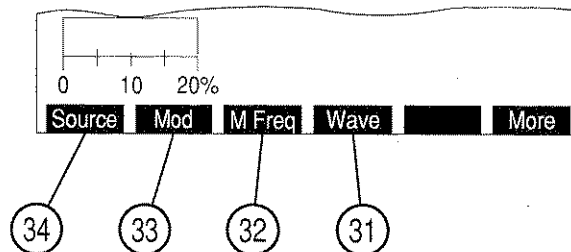

03416034

31. "Wave" Soft Function Key F4

Appears if Source 1 or 2 is the last selected Source. Selects Modulation Wave Form. Select Sine, Square, Ramp, Triangle, Pulse, +1 Lvl, 0 Lvl or -1 Lvl.

32. "M Freq" Soft Function Key F3

Appears if Source 1 or 2 is the last selected Source. Selects Modulation Audio Frequency. Range is 0.0 to 40000.0 Hz.



ITEM	DESCRIPTION
------	-------------

33. "Mod"/"Dev" Soft Function Key F2

Appears if Source 1 or 2 is the last selected Source. Selects Modulation Level. Range is 0% to 90% for AM Modulation, 0.0 to 100.0 kHz for FM Modulation, 0.0 to 10.0 radians for PM Modulation.

34. "Source" Soft Function Key F1

Edits Modulation Sources. Select AM, FM, PM or OFF.

The following set of Soft Function Keys are accessed with a full size Spectrum Analyzer Display:

ITEM	DESCRIPTION
------	-------------

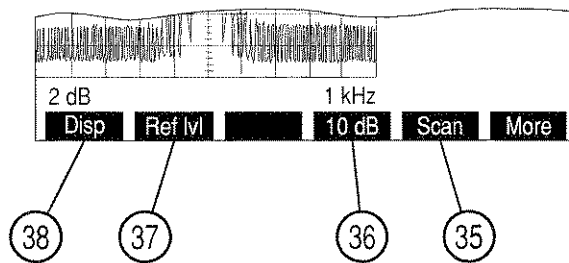

03416035

35. "Scan" Soft Function Key F5

Selects Analyzer Scan Width. Select Zero Scan (0 kHz) or:

- |         |         |         |
|---------|---------|---------|
| 1 kHz   | 2 kHz   | 5 kHz   |
| 10 kHz  | 20 kHz  | 50 kHz  |
| 100 kHz | 200 kHz | 500 kHz |
| 1 MHz   |         |         |

36. "10 dB"/"2 dB" Soft Function Key F4

Toggles Units/Division Factor between 10 and 2 dB/div.

37. "Ref lvl" Soft Function Key F2

Appears with 2 dB vertical scale. Adjusts vertical grid position of the Spectrum Analyzer Trace.

38. "Disp" Soft Function Key F1

Menu appears listing Oscilloscope displays, Spectrum Analyzer displays and None. Select desired display using DATA ENTRY Keypad.

The following set of Soft Function Keys are accessed when the Oscilloscope is displayed:

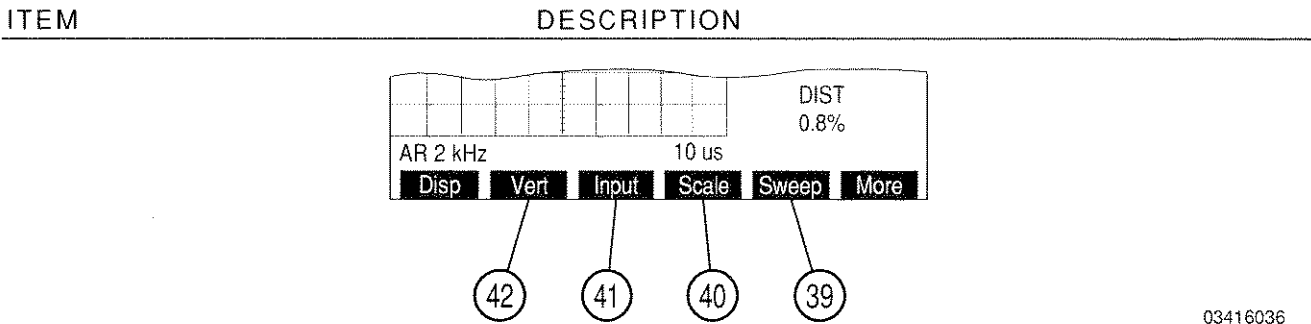

03416036

39. "Sweep" Soft Function Key F5

Appears with full size Oscilloscope except with "Rcvr IF" as Oscilloscope Input. Select one of the following:

- |             |             |             |
|-------------|-------------|-------------|
| 1 $\mu$ s   | 2 $\mu$ s   | 5 $\mu$ s   |
| 10 $\mu$ s  | 20 $\mu$ s  | 50 $\mu$ s  |
| 100 $\mu$ s | 200 $\mu$ s | 500 $\mu$ s |
| 1 ms        | 2 ms        | 5 ms        |
| 10 ms       | 20 ms       | 50 ms       |
| 100 ms      |             |             |

40. "Scale" Soft Function Key F4

Selects Oscilloscope Scale. Appears with full size Oscilloscope, except when the Oscilloscope Input is SINAD/BER, Rcvr IF, RF Pwr Lvl or Demod Audio (with Receiver Modulation other than FM). For AC, DC or GND Oscilloscope Input, select one of the following:

- |            |            |            |
|------------|------------|------------|
| 1 mV/div   | 2 mV/div   | 5 mV/div   |
| 10 mV/div  | 20 mV/div  | 50 mV/div  |
| 100 mV/div | 200 mV/div | 500 mV/div |
| 1 V/div    | 2 V/div    | 5 V/div    |
| 10 V/div   | 20 V/div   | 50 V/div   |

For Func Gen or Ext Mod Oscilloscope Input, select one of the following:

- |            |         |           |
|------------|---------|-----------|
| 500 mV/div | 1 V/div | 2.5 V/div |
|------------|---------|-----------|

For Demod Audio Oscilloscope Input with FM Modulation, select one of the following:

- |            |           |            |
|------------|-----------|------------|
| 2 kHz/div  | 4 kHz/div | 10 kHz/div |
| 20 kHz/div | Autorange |            |

Oscilloscope Scale is fixed at 13% MOD and 5 RAD for Oscilloscope Input set to Demod Audio with Modulation set to AM and PM, respectively.

Oscilloscope Scale is blank for Oscilloscope Input set to Demod Audio with Modulation set to OFF or BFO.

Oscilloscope Scale is fixed at 4 V/div and blank for Oscilloscope Input SINAD/BER and Rcvr IF, respectively.

## ITEM

## DESCRIPTION

For RF Pwr Lvl Oscilloscope Input, Oscilloscope scale is replaced with 100 mW Rng or 50 W Rng. Power Meter Ranges\* of 20, 50 or 100 mW set Oscilloscope Scale to 100 mW Rng. All other Power Meter Ranges\* set Oscilloscope Scale to 50 W Rng.

\* RF Power Meter works with two primary ranges: 100 mW and 50 W. The field labeled "Range" on the Power Meter Operation screen also represents the current meter scale used within the primary ranges.

41. "Input" Soft Function Key F3

Selects Oscilloscope Input. Choose one of the following:

SINAD/BER	Func Gen	Ext Mod
AC	DC	GND

42. "Vert" Soft Function Key F2

Appears with full size Oscilloscope. Adjusts vertical trace position on Oscilloscope. When Oscilloscope Trace is adjusted below Oscilloscope display, an arrow appears on the right bottom edge of the display. When Oscilloscope Trace is adjusted above Oscilloscope display, an arrow appears on the right top edge of the display.

### C. DUPLEX RECEIVER MENU

When the Duplex Receiver Operation Screen is displayed or when the cursor is on any parameter on the left side of the Duplex Operation Screen, press SETUP Key to access the Duplex Receiver Menu. Many Duplex Receiver Operating Screen parameters are edited from the Duplex Receiver Menu or one of its submenus.

MENU ITEM	DESCRIPTION
-----------	-------------

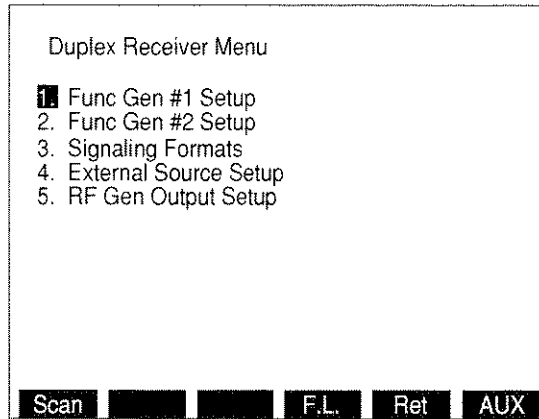

8616007

1. Func Gen #1 Setup  
Displays Func Gen #1 Setup Menu.
2. Func Gen #2 Setup  
Displays Func Gen #2 Setup Menu.
3. Signaling Formats  
Displays Signaling Format Menu featuring DTMF, Audio, Digital and RCC.
4. External Source Setup  
Displays External Source Setup Menu.
5. RF Gen Output Setup  
Displays RF Generator Setup Menu.

The following set of Soft Function Keys are available with the Duplex Receiver Menu:

ITEM	DESCRIPTION
------	-------------

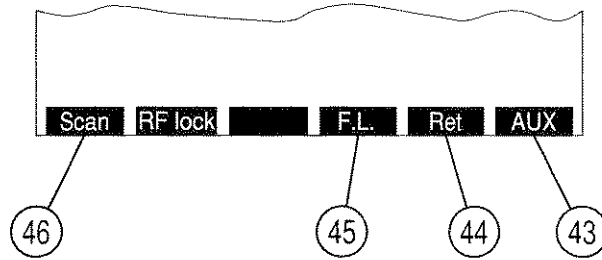

03416037

43. "AUX"/"ESC" Soft Function Key F6

"ESC" appears while parameters are accessed for editing. Allows edit procedure to be canceled without changing parameter. "AUX" displays Auxiliary Functions Menu.

44. "Ret" Soft Function Key F5

Returns operation to Duplex Receiver Screen.

45. "F.L." Soft Function Key F4

Displays the Frequency List Setup Screen.

ITEM	DESCRIPTION
------	-------------

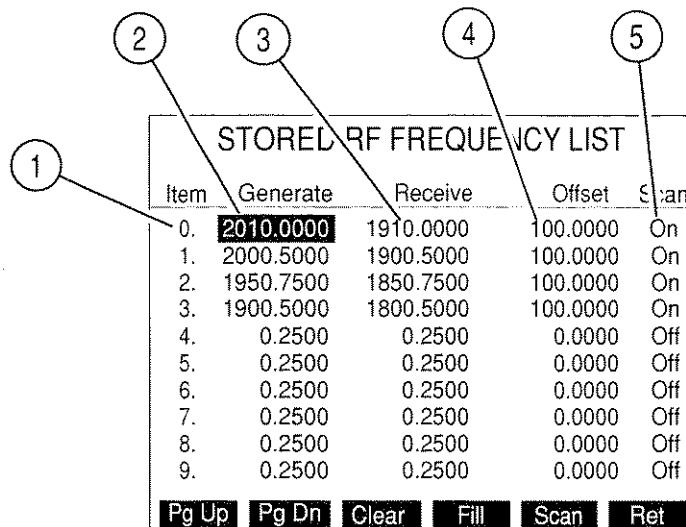

03416001

1. Item

Identifies each line in the RF Frequency List. There are 100 (0 to 99) lines with 10 on the screen at a time.

ITEM	DESCRIPTION
2. <u>Generate</u>	The column of frequencies for the RF Generator and Duplex Receiver operations. Use FIELD SELECT Keys (1) to move cursor to an item line in the Generate column and press ENTER Key to activate data field. Use DATA ENTRY Keypad (29) to enter desired frequency and press ENTER Key.
3. <u>Receive</u>	The column of frequencies for the Receiver and Duplex Transmitter operations. Use FIELD SELECT Keys (1) to move cursor to an item line in the Receive column and press ENTER Key to activate data field. Use DATA ENTRY Keypad (29) to enter desired frequency and press ENTER Key.
4. <u>Offset</u>	The column which specifies or reflects the difference between Generate and Receive frequency columns. If a value is entered into this column, the value in the Generate column is changed to maintain the difference between Generate and Receiver frequencies specified. The difference between Generate and Receive frequencies is equal to Generate minus Receive. Use FIELD SELECT Keys (1) to move cursor to an item line in the Offset column and press ENTER Key to activate data field. Use DATA ENTRY Keypad (29) to enter desired frequency and press ENTER Key.
5. <u>Scan</u>	Used for Frequency List Scan Mode only. Item lines are skipped during scanning if Scan is turned Off. Use FIELD SELECT Keys (1) to move cursor to an item line in the Scan column and press ENTER Key to toggle between On or Off.

The following set of Soft Function Keys are available with the Frequency List Setup Screen

ITEM	DESCRIPTION

8616019

6. "Ret"/"ESC" Soft Function Key F6
- "ESC" appears while parameters are accessed for editing. Allows edit procedure to be canceled without changing parameter. "Ret" returns operation to Duplex Receiver Operation Screen.

ITEM	DESCRIPTION
7. <u>"Scan" Soft Function Key F5</u>	<p>Displays the Duplex Receiver Frequency Scan List Menu.</p> <ul style="list-style-type: none"> <li data-bbox="347 348 540 375">● <u>Scan Rate</u></li> </ul> <p>This is the rate at which the Duplex Receiver hops to the next frequency. Range is 0.02 to 99.99 sec.</p>
8. <u>"Fill" Soft Function Key F4</u>	<p>When pressed, fills or repeats the frequency value selected by the cursor for each of items below the cursor and in the same column.</p>
9. <u>"Clear" Soft Function Key F3</u>	<p>Returns the selected element of the Generate, Receive, Offset or Scan columns to the default value. Generate and Receive frequencies are returned to 0.2500 MHz. Offset frequencies are returned to zero. Scan is returned to OFF.</p>
10. <u>"Pg Dn" Soft Function Key F2</u>	<p>When pressed, displays the following page of ten item lines in the Stored RF Frequency List.</p>
11. <u>"Pg Up" Soft Function Key F1</u>	<p>When pressed, displays the previous page of ten item lines in the Stored RF Frequency List.</p>

## ITEM

DESCRIPTION

---

46. "Scan" Soft Function Key F1

Displays Duplex Receiver Frequency Scan Menu.

● Start Freq

Selects starting frequency for RF Frequency Scan. Range is from 0.2500 to 2010.0000 MHz.

● Stop Freq

Selects upper limit frequency for RF Frequency Scan. Range is from 0.2500 to 2010.0000 MHz.

● Increment

Selects increment between scanned frequencies. Range is from 0.0000 to 2010.0000 MHz.

● Scan Rate

Selects time period for each generated frequency. Range is from 0.02 to 99.99 sec.



Selecting "1. Func Gen #1 Setup" displays the Function Generator #1 Setup Menu:

MENU ITEM DESCRIPTION

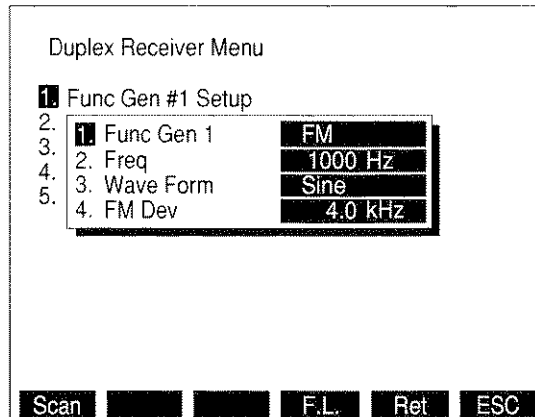

8610355

1. Func Gen 1

Selects Function Generator Modulation Type. Select AM, FM, PM or OFF.

2. Freq

Selects Function Generator Frequency. Range is 0.0 to 40000 Hz.

3. Wave Form

Selects Function Generator Wave Form. Select Sine, Square, Ramp, Triangle, Pulse, +1 Lvl, 0 Lvl, -1 Lvl.

4. Level Setting

Operational only when Function Generator is On. Selects Function Generator Modulation Level. Range is 0.0 to 100.0 kHz for FM Modulation, 0% to 90% for AM Modulation or 0.0 to 10.0 radians for PM Modulation.

Accessing "2. Func Gen #2 Setup" displays the Function Generator #2 Setup Menu. Function Generator #2 parameters are identical to those of Function Generator #1.

When "3. Signaling Formats" is selected on the Duplex Receiver Menu, the following menu appears on the color display:

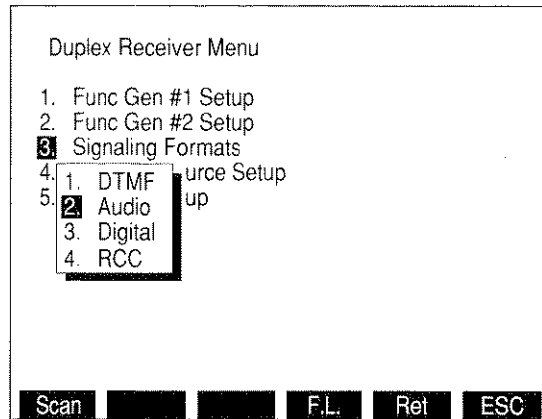

8610356

If "1. DTMF" is selected, the DTMF Format Menu appears on the screen:

ITEM DESCRIPTION

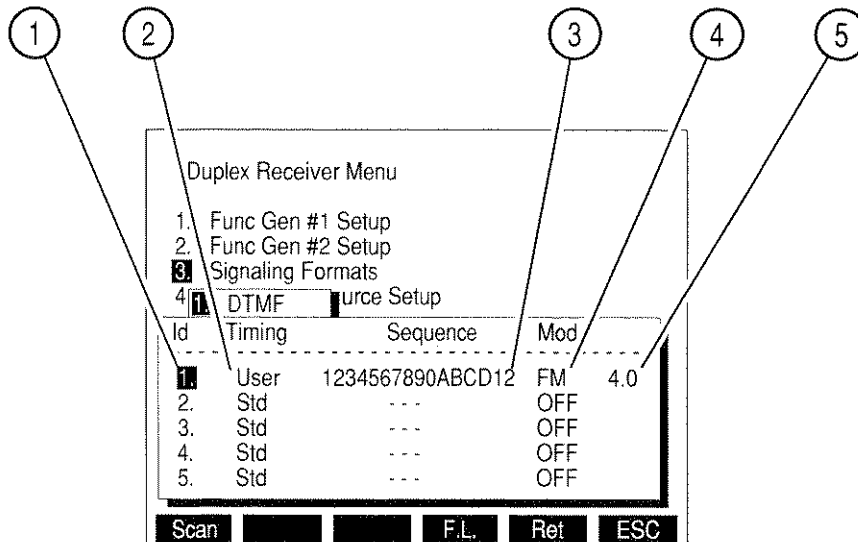

8607332

1. Id

Program Identification number. Used to select a specific sequence from the Operation Screen while using the Program feature.

2. Timing

Choose from Std (standard) or User (user defined). If User is selected, two data fields appear allowing entry of desired Mark Timing and Space Timing. Range of both is 25 to 9999 ms.

3. Sequence

Select the desired sequence of up to 15 tones using digits 0 through 9, letters A through D, # character and the \* character.

ITEM

DESCRIPTION

4. Mod Type

Select AM, FM, PM or OFF for the DTMF Modulation.

5. Mod Level

Modulation Level range is 0.0 to 10.0 kHz for FM, 0.0% to 12.5% for AM, 0.0 to 1.5 radians for PM.

If Audio is selected as the Signaling Format, the Audio Code Menu appears:

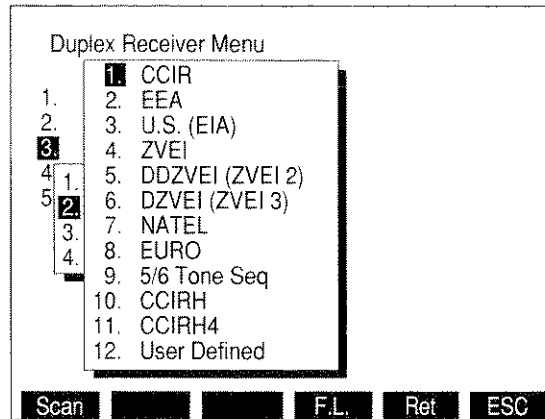

8610357

Selecting an Audio Code displays the Audio Code Sequence Menu:

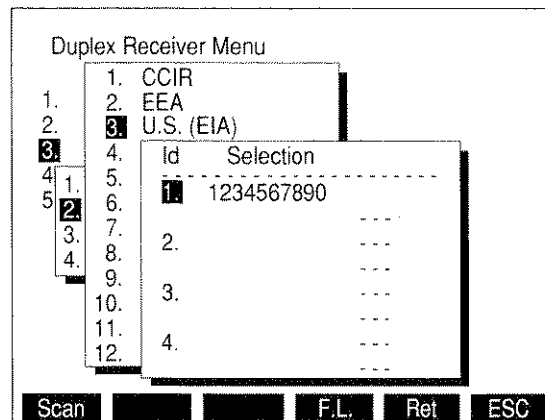

8610358

Select the Id number from 1 to 16. Enter a sequence up to 30 tones in length using the characters 0 through 9, A, G, R and - signifying a blank space.

Selecting "12. User Defined" for the Audio Code displays the Audio Code User Defined Menu:

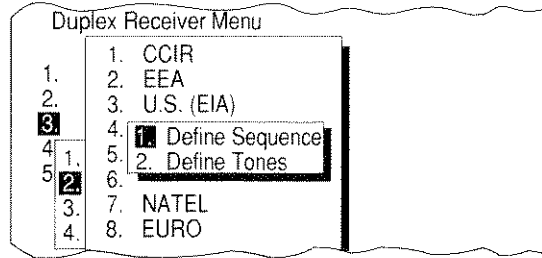

8610170

Selecting "2. Define Tones" displays a menu used to define the desired tones:

ITEM	DESCRIPTION
1.	CCIF
2.	EEA
3.	U.S. (EIA)
4.	1. Define Sequence
5.	2. Define Tones
6.	
7.	NATEL
8.	EURO

ITEM	DESCRIPTION
1.	CCIF
2.	EEA
3.	U.S. (EIA)
4.	1. Define Sequence
5.	2. Define Tones
6.	Id
7.	Tone(Hz)
8.	Duration(ms)
9.	0
10.	1
11.	2
12.	3
	4
	5
	6
	7

Scan      Fill      Ret      ESC

8610360

1. "Fill" Soft Function Key F4

When a Tone or Duration is highlighted, pressing Soft Function Key F4 changes all entries below and in the same column to the value highlighted.

2. Id

Identification number representing the tone to be defined. Range of characters for the Id is 0 to 9 and A to T. Defining the tone consists of setting the frequency and duration of the tone.

3. Tone(Hz)

Set "Tone(Hz)" to frequency of desired tone. Range is 0.0 to 9999.9 Hz.

4. Duration(ms)

Set "Duration(ms)" to duration of desired tone. Range is 20 to 9999 ms.

Selecting "1. Define Sequence" displays the Duplex Receiver Audio Code Sequence Menu. User Defined sequences are selected as other Audio Codes using this menu.

If "3. Digital" is selected as the Signaling Format, the Digital Code Menu appears:

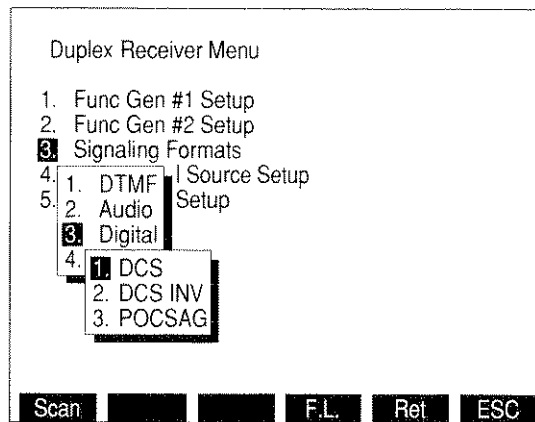

8610361

Selecting DCS or DCS INV displays the DCS Code Menu:

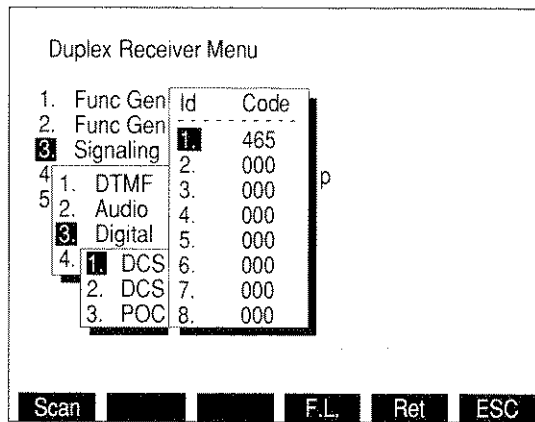

8610362

After selecting the Id number (1 to 16), enter a 3 digit DCS Code.

Selecting POCSAG from the Digital Code Menu displays the POCSAG Menu:

MENU ITEM	DESCRIPTION
-----------	-------------

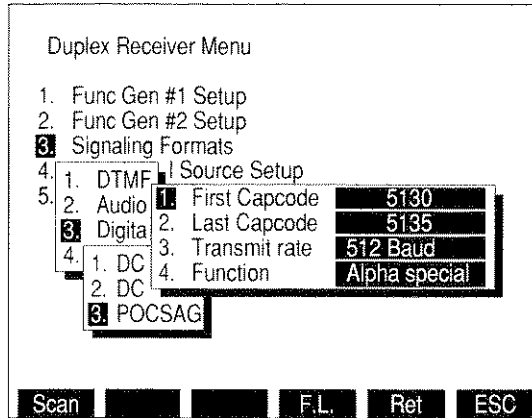

8616008

1. First Capcode

Selects beginning Capcode of sequence. Range of Capcodes is 1 to 2097151. Sequence generated consists of Capcodes from First Capcode through Last Capcode.

2. Last Capcode

Selects ending Capcode of Capcode sequence. Range of Capcodes is 1 to 2097151. Sequence generated consists of Capcodes from First Capcode through Last Capcode.

3. Transmit Rate

Selects Transmit Rate submenu. Choose 512 Baud or 1200 Baud.

4. Function

Selects POCSAG Function Submenu. Choose one of the following:

Tone - 1 beep	Tone - 2 beeps	Tone - 3 beeps
Tone - 4 beeps	Numeric	Numeric seq
Alpha lower	Alpha upper	Alphanumeric
Alpha special		

If RCC is selected for the Signaling Format, the RCC Code Menu appears:

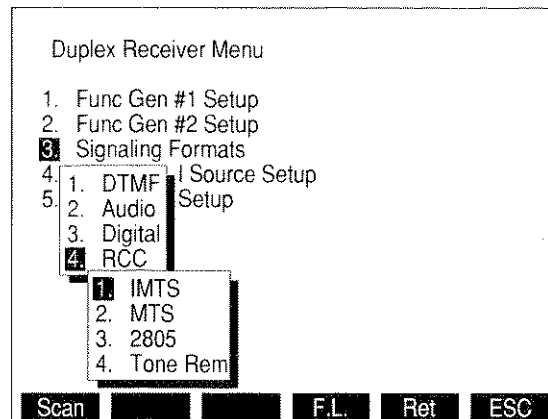

8610363

Selecting IMTS, MTS or 2805 displays the following menu:

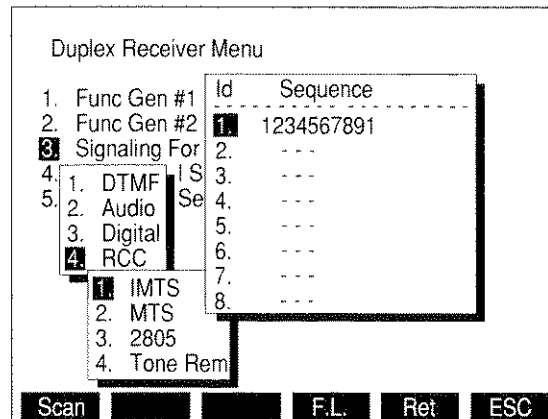

8610364

After selecting an Id, select the sequence to be generated using characters 1 through 9.

If 2805 is selected, "Tone" Soft Function Key F3 appears. Accessing F3 displays the 2805 Tone Freq data field allowing this frequency to be changed. Range of Tone Freq is 0.0 to 40000.0 Hz.

Selecting Tone Rem displays the Tone Remote Function Menu. Select one of the following:

- 2050 (Monitor)
- 1750 (R2 Mute)
- 1450 (Repeater On)
- 1150 (Wild Card 2 On)
- 1950 (F1)
- 1650 (R2 Unmute)
- 1350 (Wild Card 1 On)
- 1050 (Wild Card 2 Off)
- 1850 (F2)
- 1550 (Repeater Off)
- 1250 (Wild Card 1 Off)

When "4. External Source Setup" is selected on the Duplex Receiver Menu, the following menu appears on the color display:

MENU ITEM	DESCRIPTION
-----------	-------------

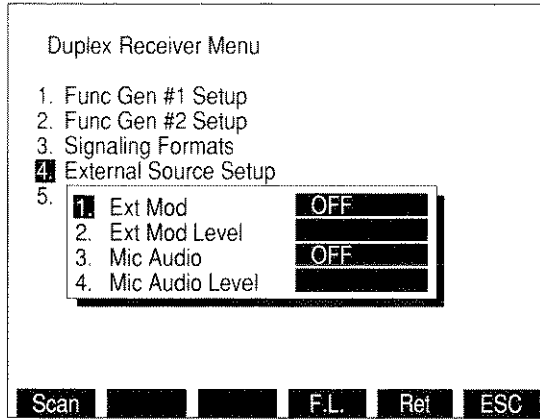

8610365

1. Ext Mod

Selects External Modulation Type. Select FM, AM, PM or OFF.

2. Ext Mod Level

Selects External Modulation Level. Select from 0.0 to 100.0 kHz for FM, 0% to 90% for AM or 0.0 to 10.0 radians for PM. Field is blank if set to OFF.

**NOTE:** External Modulation Level setting assumes the modulating signal applied to the EXT MOD IN Connector is 3.54 VRMS. For lower input voltages, Modulation Level setting is set higher to achieve the modulation level desired as per the following equation:

$$\begin{array}{rcccl} \text{Modulation} & & \text{EXT MOD IN} & & \text{Actual} \\ \text{Level setting} & \times & \text{Connector} & \div & \text{Modulation} \\ \text{(kHz, \%, rad)} & & \text{Input (VRMS)} & & \text{Level} \\ & & & & 3.54 \end{array} =$$

3. Mic Audio

Select FM, AM, PM or OFF for Microphone Input Modulation Type.

4. Mic Audio Level

Selects Microphone Input Modulation Level. Select from 0.0 to 100.0 kHz for FM, 0% to 90% for AM or 0.0 to 10.0 radians for PM. Field is blank if set to OFF.



When "5. RF Gen Output Setup" is selected on the Duplex Receiver Menu, the Duplex Receiver Setup Menu appears on the color display:

MENU ITEM DESCRIPTION

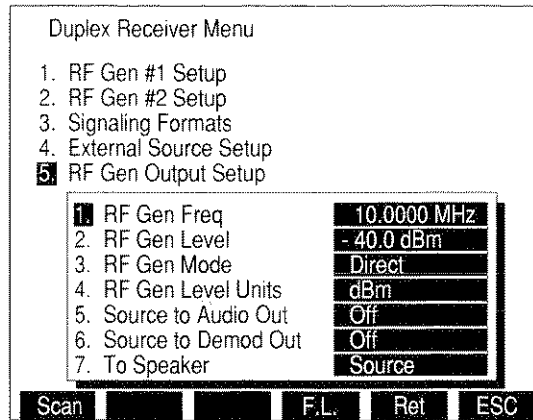

03416119

1. RF Gen Freq

Selects Duplex Receiver Frequency or Cellular Channel. For Direct Mode, select 0.2500 to 2010.0000 MHz. For Channel Mode, select 1 to 2047, depending on channel format.

2. RF Gen Lvl

The Duplex Receiver Output range for corresponding output connector and units is as follows:

UNITS	OUTPUT CONNECTOR	
	T/R	DPL (DUPLEX)
dBm	-137.0 to 0.0 dBm	-120.0 to 10.0 dBm
Volts	0.031 $\mu$ V to 0.224 V	0.224 $\mu$ V to 0.707 V

3. RF Gen Mode

Selects Duplex Receiver Operation Mode. Displays RF Gen Mode Submenu. Allows selection of Direct (normal operation), Channel, Freq Scan, Freq List or Freq List Scan. Freq Scan Mode allows for scanning while in the Duplex Transmitter Operation Screen. Independent scan parameters are specified in the Stored RF Frequency List, accessible by means of "F.L." Soft Function Key F4. When in Freq List or Freq List Scan Mode, the Duplex Receiver Operation Screen shares a common frequency list with the RF Generator, Receiver, Duplex and Duplex Transmitter Operation Screens.

"Chan" Soft Function Key F2 appears when Channel Mode is selected. When the "Chan" Soft Function Key F2 is selected, the Duplex Receiver Channel Format Menu appears listing available Cellular Channel Formats:

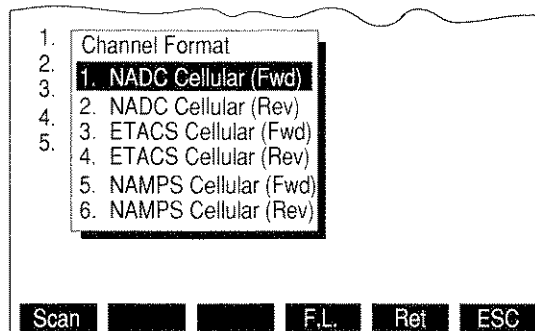

03416004

If an NADC Cellular channel format is selected, the NADC Cellular format menu appears:

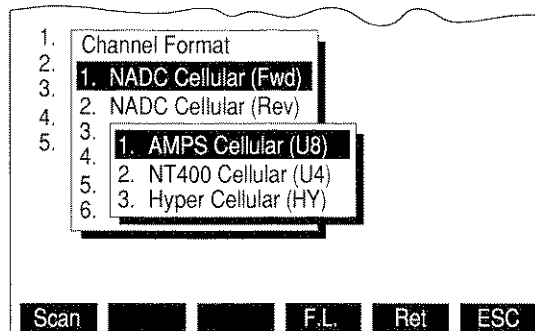

03416005

The operator may select AMPS, NT400© or Hyperband channel format.

MENU ITEM	DESCRIPTION
-----------	-------------

---

4. RF Gen Level Units

Selects Duplex Receiver Output Level Units. Accessing toggles units to "dBm" or "Volts."

5. Source to Audio Out

Sets routing of Modulation Source to AUDIO OUT Connector. Accessing toggles routing to On or Off.

6. Source to Demod Out

Sets routing of Modulation Source to DEMOD OUT Connector. Accessing toggles routing to On or Off.

7. To Speaker

Displays menu listing signals to be routed to Speaker. Select None, Source, SINAD/BER or Ext Mod/DTMF.

**NOTE:** Routing the Source to the Speaker disables SINAD and Distortion Meters.

### 3-3-6 AF GENERATOR OPERATION SCREEN

Press AF GEN MODE Key to access AF Generator Operating Screen.

The following Screen Parameters portion identifies the operation screen parameters that are edited, the value range available and/or usage of each feature. When editing, use the FIELD SELECT Keys to move the cursor to the parameter to be edited and press ENTER Key to access the data field. Use the DATA ENTRY Keypad to enter numerical data. Use the DATA SCROLL Spinner or DATA SCROLL ↑ and ↓ Keys (3) to select parameters from a list. Parameters with only two possible settings automatically switch to the opposite setting when selected.

All available Soft Function Keys are on one screen.

#### A. SCREEN PARAMETERS

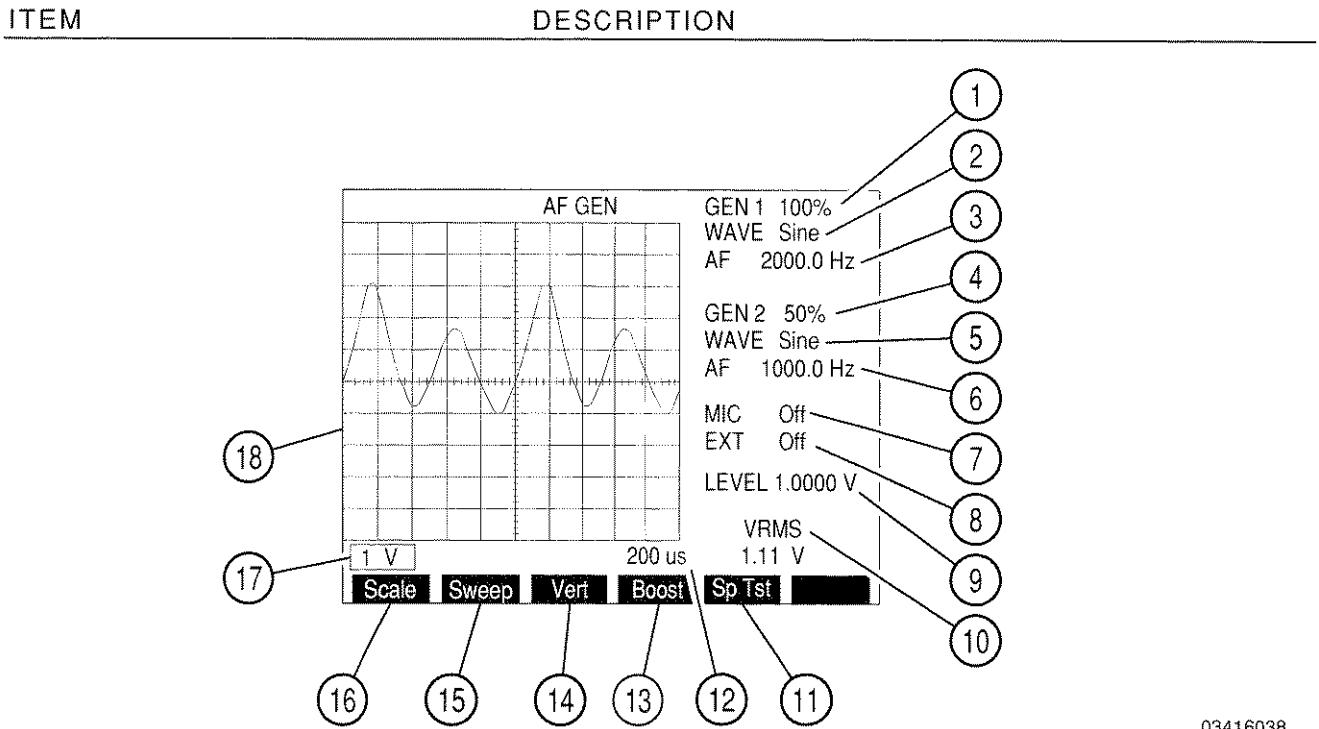

03416038

#### 1. GEN 1

Selects AF Generator #1 Status. For Proportional Output select 0% to 100%; otherwise select On and Off. Proportional Output is selected from AF Gen Menu.

#### 2. WAVE (GEN 1)

Selects AF Generator #1 Output Wave Form. Select Sine, Square, Ramp, Triangle, Pulse, +1 Lvl 0 Lvl, or -1 Lvl.

#### 3. AF (GEN 1)

Selects AF Generator #1 Audio Frequency. Range is 0.0 to 40000.0 Hz.

ITEM	DESCRIPTION
------	-------------

4. GEN 2

Selects AF Generator #2 Status. For Proportional Output select 0% to 100%; otherwise select on or off. Proportional Output is selected from AF Gen Menu.

5. WAVE (GEN 2)

Selects AF Generator #2 Output Wave Form. Select Sine, Square, Ramp, Triangle, Pulse, +1 Lvl 0 Lvl, or -1 Lvl.

6. AF (GEN 2)

Selects AF Generator #2 Audio Frequency. Range is 0.0 to 40000.0 Hz.

7. MIC

Selects AF Generator Status at MIC/ACC Connector. For Proportional Output select 0% to 100%; otherwise select on or off. Proportional Output is selected from AF Gen Menu.

8. EXT

Selects AF Generator Status at EXT MOD IN Connector. For Proportional Output select 0% to 100%; otherwise select on or off. Proportional Output is selected from AF Gen Menu.

9. LEVEL

Selects Individual Source Output Level. Range is 0.0000 to 3.1000 V. Maximum Output Level of combined Sources is 4.0 VRMS. (See "Boost" Soft Function Key F4.)

10. VRMS

Displays VRMS level of AF Generator Output.

11. "Sp Tst" Soft Function Key F5

Displays Dual Mode IS-136 Cellular Menu.

12. Oscilloscope Sweep Rate

Select one of the following:

- |             |             |             |
|-------------|-------------|-------------|
| 1 $\mu$ s   | 2 $\mu$ s   | 5 $\mu$ s   |
| 10 $\mu$ s  | 20 $\mu$ s  | 50 $\mu$ s  |
| 100 $\mu$ s | 200 $\mu$ s | 500 $\mu$ s |
| 1 ms        | 2 ms        | 5 ms        |
| 10 ms       | 20 ms       | 50 ms       |
| 100 ms      |             |             |

ITEM	DESCRIPTION																		
13. <u>"Boost" Soft Function Key F4</u>	Synchronizes GEN 2 with GEN 1 to allow AUDIO output level to reach 4.0 Vrms. GEN 2 is removed from the screen.																		
14. <u>"Vert" Soft Function Key F3</u>	Adjusts vertical position of Oscilloscope Trace by using DATA SCROLL Spinner. When Oscilloscope Trace is adjusted below Oscilloscope display, an arrow appears on the right bottom edge of the display. When Oscilloscope Trace is adjusted above Oscilloscope display, an arrow appears on the right top edge of the display.																		
15. <u>"Sweep" Soft Function Key F2</u>	Selects Oscilloscope Sweep Rate. Select one of the following:																		
	<table> <tbody> <tr> <td>1 <math>\mu</math>s</td> <td>2 <math>\mu</math>s</td> <td>5 <math>\mu</math>s</td> </tr> <tr> <td>10 <math>\mu</math>s</td> <td>20 <math>\mu</math>s</td> <td>50 <math>\mu</math>s</td> </tr> <tr> <td>100 <math>\mu</math>s</td> <td>200 <math>\mu</math>s</td> <td>500 <math>\mu</math>s</td> </tr> <tr> <td>1 ms</td> <td>2 ms</td> <td>5 ms</td> </tr> <tr> <td>10 ms</td> <td>20 ms</td> <td>50 ms</td> </tr> <tr> <td>100 ms</td> <td></td> <td></td> </tr> </tbody> </table>	1 $\mu$ s	2 $\mu$ s	5 $\mu$ s	10 $\mu$ s	20 $\mu$ s	50 $\mu$ s	100 $\mu$ s	200 $\mu$ s	500 $\mu$ s	1 ms	2 ms	5 ms	10 ms	20 ms	50 ms	100 ms		
1 $\mu$ s	2 $\mu$ s	5 $\mu$ s																	
10 $\mu$ s	20 $\mu$ s	50 $\mu$ s																	
100 $\mu$ s	200 $\mu$ s	500 $\mu$ s																	
1 ms	2 ms	5 ms																	
10 ms	20 ms	50 ms																	
100 ms																			
16. <u>"Scale" Soft Function Key F1</u>	Selects Oscilloscope Scale. Select 500 mV, 1 V or 2.5 V.																		
17. <u>Oscilloscope Scale</u>	Selects Oscilloscope Scale. Select 500 mV, 1 V or 2.5 V.																		
18. <u>Oscilloscope</u>	Oscilloscope displays AF Generator Output.																		

## B. AF GENERATOR MENU

When the AF Generator Operation Screen is displayed, press SETUP Key to access the AF Generator Menu. Many AF Generator Operating Screen parameters are edited from the AF Generator Menu or one of the submenus.

MENU ITEM	DESCRIPTION
-----------	-------------

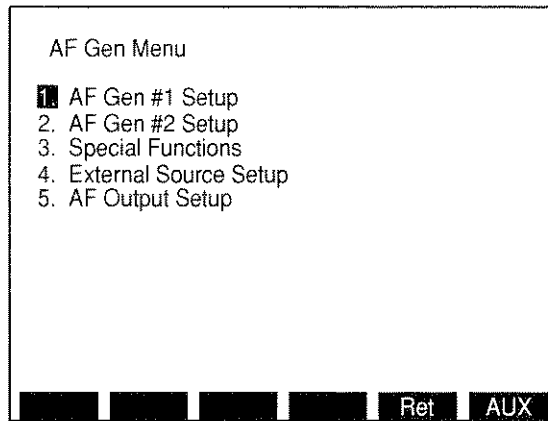

8610013

1. AF Gen #1 Setup

Displays AF Generator #1 Menu.

2. AF Gen #2 Setup

Displays AF Generator #2 Menu.

3. Special Functions

Displays menu listing AF Scan and Tone Remote. Selecting a function displays the Functions Menu.

4. External Source Setup

Displays External Source Menu.

5. AF Output Setup

Displays AF Output Menu.

Selecting "1. AF Gen #1 Setup" displays the AF Generator #1 Menu:

MENU ITEM

DESCRIPTION

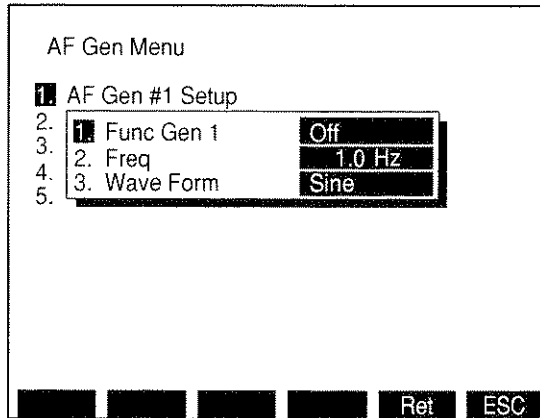

8610014

1. Func Gen 1

Selects AF Generator Status. For Proportional Output select from 0% to 100%; otherwise select on or off.

2. Freq

Selects AF Generator Frequency. Range is 0.0 to 40000.0 Hz.

3. Wave Form

Selects AF Generator Wave Form. Select Sine, Square, Ramp, Triangle, Pulse, +1 Lvl, 0 Lvl or -1 Lvl.

Selecting "2. AF Gen #2 Setup" displays the AF Generator #2 Menu. AF Generator #2 parameters are identical to those of AF Generator #1.



Selecting "3. Special Functions" displays the Special Functions Menu. Selecting "1. AF Scan" displays the Audio Frequency Scan Menu:

MENU ITEM	DESCRIPTION
-----------	-------------

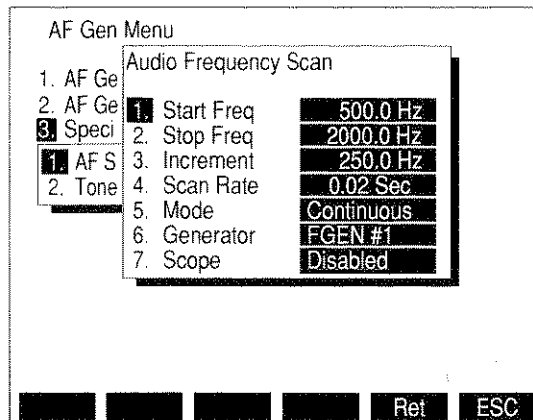

8610102

1. Start Freq

Selects starting frequency for AF Scan. Range is 0.0 to 40000.0 Hz.

2. Stop Freq

Selects ending frequency for AF Scan. Range is 0.0 to 40000.0 Hz.

3. Increment

Selects increment between generated frequencies. Range is 0.0 to 40000.0 Hz.

4. Scan Rate

Blank if "7. Scope" is enabled. Selects length of time each frequency is generated. Range is 0.02 to 99.99 sec.

5. Mode

Selects AF Scan Mode. Choose Continuous or One Shot. Continuous allows AF Scan to repeat until STOP TEST CONTROL Key is pressed. One Shot Mode generates the AF Scan once. Pressing GO TEST CONTROL Key starts the AF Scan regardless of Mode.

6. Generator

Selects AF Generator used for AF Scan. Toggles between AF Generator #1 or AF Generator #2.

7. Scope

Enables or disables Oscilloscope. With enabled Oscilloscope, Scan Rate adjustment is not available.

If "3. Special Functions" is selected and "2. Tone Remote" is selected, the Tone Remote Function Menu appears. Select the Tone Remote Function desired.

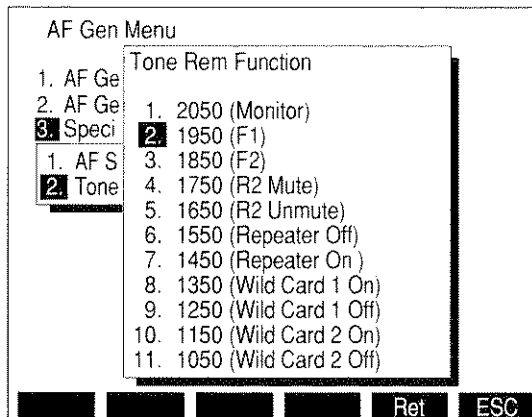

8610158

Selecting "4. External Source Setup" displays the AF Generator External Source Menu:

MENU ITEM	DESCRIPTION
-----------	-------------

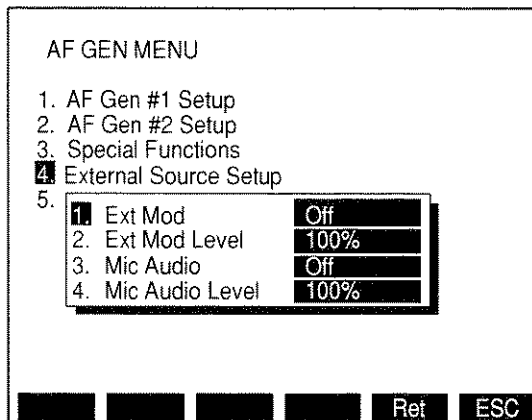

8610016

1. Ext Mod

Selects EXT MOD IN Connector as AF Generator Input. Select On or Off.

2. Ext Mod Level

Sets EXT MOD IN Connector's Proportional Level. Range is 0% to 100%. Applicable only if Ext Mod and Proportional Level are On.

3. Mic Audio

Selects MIC/ACC Connector as AF Generator Input. Select On or Off.

4. Mic Audio Level

Sets MIC/ACC Connector's Proportional Level. Range is 0% to 100%. Applicable only if Mic Audio and Proportional Level are On.

Selecting "5. AF Output Setup" displays the AF Output Menu:

MENU ITEM DESCRIPTION

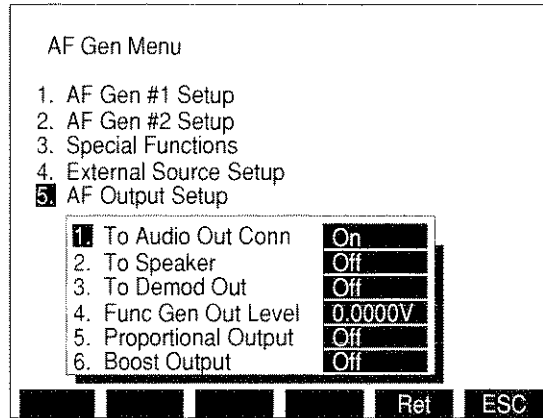

8610328

1. To Audio Out Conn

Sets routing of AF Generator Output to AUDIO OUT Connector. Select On or Off.

2. To Speaker

Sets routing of AF Generator Output to the Speaker. Select On or Off.

3. To Demod Out

Sets routing of AF Generator Output to DEMOD OUT Connector. Select On or Off.

4. Func Gen Out Level

Stores an output attenuation setting for Proportional Output on and another setting for Proportional Output off. Range is 0.0000 to 3.1000 V.

5. Proportional Output

Sets AF Generator Proportional Output to On or Off.

**NOTE:** If Boost is initially on, Boost is turned off when Proportional Output is toggled On.

6. Boost Output

Sets AF Generator Boost Output to on or off.

**NOTE:** If Proportional Output is initially on, Proportional Output is toggled Off and On when Boost Output is toggled On and Off.

### 3-3-7 OSCILLOSCOPE OPERATION SCREEN

Press SCOPE/ANLZ MODE key to access the Oscilloscope Operating Screen. Both the Spectrum Analyzer and Oscilloscope are accessed with the SCOPE/ANLZ MODE Key, if necessary, press SCOPE/ANLZ MODE Key twice to access the Oscilloscope Operation Screen. The operation of the Oscilloscope may be controlled by changing Screen Parameters, using Soft Function Keys or Setup Menus.

The following Screen Parameters portion identifies the operation screen parameters that are edited, the value range available and/or usage of each feature. When editing, use the FIELD SELECT Keys to move the cursor to the parameter to be edited and press the ENTER Key to access the data field. Use the DATA ENTRY Keypad to enter numerical data. Use the DATA SCROLL Spinner or DATA SCROLL  $\uparrow$  and  $\downarrow$  Keys to select parameters from a list. Parameters with only two possible settings automatically switch to the opposite setting when selected.

#### A. SCREEN PARAMETERS

ITEM	DESCRIPTION
------	-------------

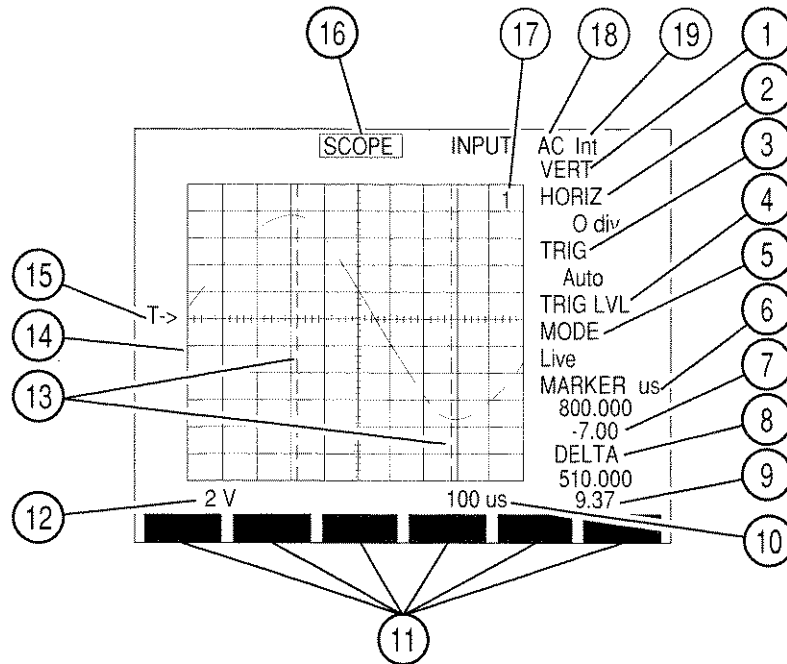

8617052

#### 1. VERT

Adjusts vertical position of Oscilloscope Trace. When Oscilloscope Trace is adjusted below Oscilloscope display, an arrow appears on the right bottom edge of the display. When Oscilloscope Trace is adjusted above Oscilloscope display, an arrow appears on the right top edge of the display.

#### 2. HORIZ

Adjusts horizontal position of Oscilloscope Trace -12 to +12 divisions to allow viewing of pre-trigger and post-trigger information. MARKER readings adjust to reflect new Trace position.

ITEM	DESCRIPTION
------	-------------

3. TRIG

Selects Trigger Mode. Select Normal, Auto or One Shot.

4. TRIG LVL

Adjusts starting position of Oscilloscope Trace.

5. MODE Setting

Displays menu of Oscilloscope Operation Modes. Select Live, Recall, Compare or Average. Live is the normal operation. Recall allows a stored Trace and set of parameters to be recalled. Compare allows the comparing of a recalled Trace and the live Trace. Average Mode averages the new sample with the last Trace to produce the new Trace.

6. MARKER

Displays active Marker position relative to Trigger position in Oscilloscope Sweep units. Marker 1 is default marker if neither marker is selected. If "Track" Function is activated, reading corresponds to Marker 1 location.

7. Marker Voltage Reading

Appears when AC, DC or GND is the Oscilloscope Input. Reads voltage of Oscilloscope Trace at point of Marker.

8. DELTA Reading

Provides time difference between Marker Positions in Oscilloscope Sweep units.

9. DELTA Voltage Reading

Appears when AC, DC or GND is the Oscilloscope Input. Reads Trace voltage difference between Marker Positions.

10. Sweep Rate

Select one of the following:

- |             |             |             |
|-------------|-------------|-------------|
| 1 $\mu$ s   | 2 $\mu$ s   | 5 $\mu$ s   |
| 10 $\mu$ s  | 20 $\mu$ s  | 50 $\mu$ s  |
| 100 $\mu$ s | 200 $\mu$ s | 500 $\mu$ s |
| 1 ms        | 2 ms        | 5 ms        |
| 10 ms       | 20 ms       | 50 ms       |
| 100 ms      |             |             |

11. Soft Function Keys

Soft Function Keys for the Oscilloscope Operation Screen are covered in 3-3-7B.

## ITEM

## DESCRIPTION

12. Oscilloscope Scale

Appears with full size Oscilloscope, except when the Oscilloscope Input is SINAD/BER or Rcvr IF or Demod Audio (with Receiver Modulation other than FM). Selects Oscilloscope Scale. For AC, DC or GND Oscilloscope Input, select one of the following:

1 mV/div	2 mV/div	5 mV/div
10 mV/div	20 mV/div	50 mV/div
100 mV/div	200 mV/div	500 mV/div
1 V/div	2 V/div	5 V/div
10 V/div	20 V/div	50 V/div

For Demod Audio Oscilloscope Input with Receiver Modulation set to FM, select one of the following:

2 kHz/div	4 kHz/div	10 kHz/div
20 kHz/div		

For Func Gen or Ext Mod Oscilloscope Input, select one of the following:

500 mV/div	1 V/div	2.5 V/div
------------	---------	-----------

Oscilloscope Scale is fixed at 13% MOD and 5 RAD for Oscilloscope Input set to Demod Audio with Modulation set to AM and PM, respectively.

Oscilloscope Scale is blank for Oscilloscope Input set to Demod Audio with Modulation set to OFF or BFO.

Oscilloscope Scale is fixed at 4 V/div and blank for Oscilloscope Input SINAD/BER and Rcvr IF, respectively.

For RF Pwr Lvl Oscilloscope Input, Oscilloscope scale is replaced with 100 mW Rng or 50 W Rng. Power Meter Ranges\* of 20, 50 or 100 mW set Oscilloscope Scale to 100 mW Rng. All other Power Meter Ranges\* set Oscilloscope Scale to 50 W Rng.

\* RF Power Meter works with two primary ranges: 100 mW and 50 W. The field labeled "Range" on the Power Meter Operation screen also represents the current meter scale used within the primary ranges.

13. Markers

Two Markers are available for use with the Oscilloscope. Markers are selected using Soft Function Keys.

14. Oscilloscope Graticule

Used to measure waveform of INPUT Source.

15. Trigger Level Indicator

Starting position of Oscilloscope Trace adjusts accessing TRIG LVL.

16. Oscilloscope Operation Screen Callout

Access to display Spectrum Analyzer Operation Screen.

ITEM	DESCRIPTION
------	-------------

17. INPUT

Displays INPUT Menu. Select Rcvr IF, Demod Audio, RF Pwr Lvl, SINAD/BER, Func Gen, Ext Mod, AC, DC or GND.

18. Recall Trace Number

Displays number corresponding to recalled trace. Trace numbers possible are 1 through 9 and are displayed only in Compare and Recall Modes.

19. Trigger Source

Appears when AC or DC is the Oscilloscope Input. Selects trigger source. Toggles between "Int" (Internal) and "Ext" (External). External trigger input is received at EXT MOD IN Connector.

B. SOFT FUNCTION KEYS

The following index lists the Soft Function Keys available for the Oscilloscope Operation Screen.

ITEM	DESCRIPTION
------	-------------

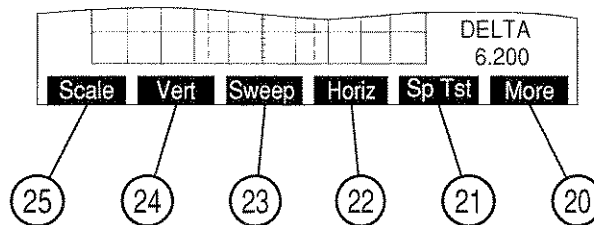

03416120

20. "More"/"ESC" Soft Function Key F6

"ESC" appears while parameters are accessed for editing. Allows edit procedure to be canceled without changing parameter. "More" displays additional sets of Soft Function Keys.

21. "Sp Tst" Soft Function Key F5

Displays Dual Mode IS-136 Cellular Menu.

22. "Horiz" Soft Function Key F4

Adjusts horizontal position of Oscilloscope Trace -12 to +12 divisions. MARKER readings adjust to reflect new Trace position. In this screen configuration, press Soft Function Key F4 to edit Horizontal Oscilloscope Trace.

ITEM	DESCRIPTION
------	-------------

23. "Sweep" Soft Function Key F3

Selects Oscilloscope Sweep Rate. Select one of the following:

1 $\mu$ s	2 $\mu$ s	5 $\mu$ s
10 $\mu$ s	20 $\mu$ s	50 $\mu$ s
100 $\mu$ s	200 $\mu$ s	500 $\mu$ s
1 ms	2 ms	5 ms
10 ms	20 ms	50 ms
100 ms		

24. "Vert" Soft Function Key F2

Adjusts vertical position of Oscilloscope Trace. When Oscilloscope Trace is adjusted below Oscilloscope display, an arrow appears on the right bottom edge of the display. When Oscilloscope Trace is adjusted above Oscilloscope display, an arrow appears on the right top edge of the display.

25. "Scale" Soft Function Key F1

Selects Oscilloscope Scale.

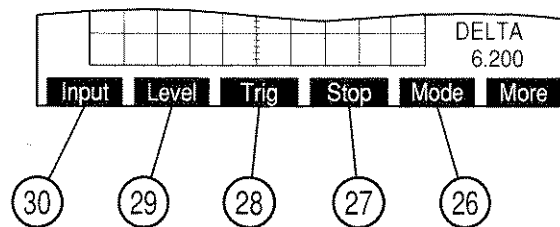

8617054

26. "Mode" Soft Function Key F5

Displays menu of Oscilloscope Operation Modes. Select Live, Recall, Compare or Average.

27. "Stop"/"Arm" Soft Function Key F4

- "Stop" appears for Normal or Auto TRIG Mode. Freezes Oscilloscope Trace. While Trace is stopped, Soft Function Key shows "Start" and is used to resume normal Oscilloscope Operation.
- "Arm" appears for One Shot TRIG Mode. Holds Trace for one screen until pressed again, then current screen is released and the next screen is held.

28. "Trig" Soft Function Key F3

Selects TRIG Mode. Select Auto, Normal or One Shot.

29. "Level" Soft Function Key F2

Adjusts starting position of Oscilloscope Trace.



## ITEM

## DESCRIPTION

30. "Input" Soft Function Key F1

Selects Oscilloscope Input. Select Rcvr IF, Demod Audio, RF Pwr Lvl, SINAD/BER, Func Gen, Ext Mod, AC, DC or GND.

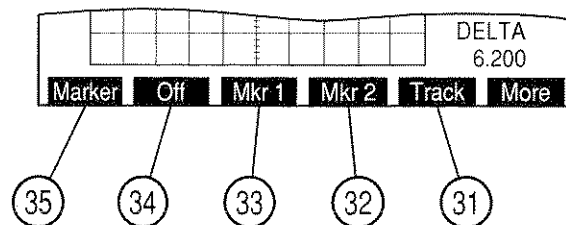

8617055

31. "Track" Soft Function Key F5

Activates Marker Tracking, locking Markers a constant distance apart. To edit marker locations, press "Marker" Soft Function Key F1. Marker Positions are changed using the DATA SCROLL Spinner. Both Markers move, but maintain the same DELTA Reading. MARKER displays Marker 1 location.

32. "Mkr 2" Soft Function Key F4

Selects Marker 2 as the active marker. When active, label highlights in red. Access Marker 2 location using "Marker" Soft Function Key F1. Deactivate by pressing "Mkr 1" Soft Function Key F3 or "Off" Soft Function Key F2.

33. "Mkr 1" Soft Function Key F3

Selects Marker 1 as the active marker. When active, label highlights in red. Access Marker 1 location using "Marker" Soft Function Key F1. Deactivate by pressing "Mkr 2" Soft Function Key F4 or "Off" Soft Function Key F2.

34. "Off" Soft Function Key F2

Deactivates and removes Markers from screen. "Off" is highlighted in red when activated.

35. "Marker" Soft Function Key F1

Activates Markers. Edits selected Marker positions. If a Marker is not selected, Marker 1 is edited.

### C. SCOPE/ANALYZER (OSCILLOSCOPE) MENU

When the Oscilloscope Operation Screen is displayed, press the SETUP Key to access the Scope/Analyzer Menu. Both the Oscilloscope and Spectrum Analyzer Operating Screens are edited from the Scope/Analyzer Menu or one of the submenus.

**NOTE:** Only one of the "1. Scope" or "2. Analyzer" Menu items may be on at a time, yet both may be turned off.

MENU ITEM	DESCRIPTION
-----------	-------------

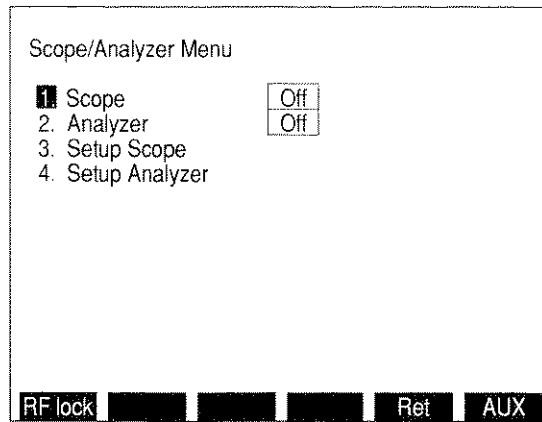

8610018

#### 1. Scope

Selects Oscilloscope display for RF Generator, Receiver, Duplex Transmitter and Duplex Receiver Operation Screens. Select On or Off.

#### 2. Analyzer

Selects Spectrum Analyzer display for RF Generator, Receiver, Duplex Transmitter and Duplex Receiver Operation Screens. Select On or Off.

#### 3. Setup Scope

Displays "Setup Scope" Menu.

#### 4. Setup Analyzer

Not applicable for Oscilloscope Operation.

Selecting "3. Setup Scope" displays the Oscilloscope Setup Menu:

MENU ITEM	DESCRIPTION
-----------	-------------

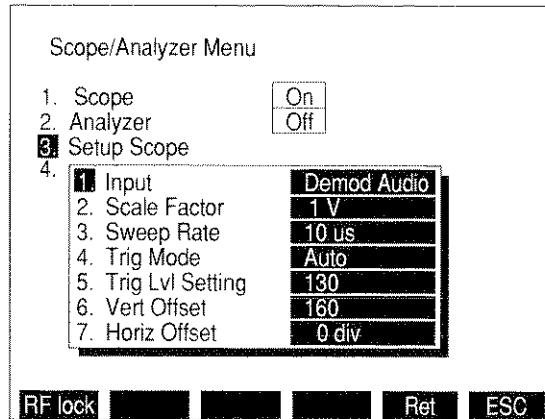

8610019

1. Input

Selects Oscilloscope Input. Select Rcvr IF, Demod Audio, RF Pwr Lvl, SINAD/BER, Func Gen, Ext Mod, AC, DC or GND. If AC or DC is selected, a submenu appears allowing selection of trigger source. Select Internal or External. External trigger input is received at EXT MOD IN Connector.

2. Scale Factor

For AC, DC or GND Oscilloscope Input, select one of the following:

1 mV/div	2 mV/div	5 mV/div
10 mV/div	20 mV/div	50 mV/div
100 mV/div	200 mV/div	500 mV/div
1 V/div	2 V/div	5 V/div
10 V/div	20 V/div	50 V/div

For Demod Audio Oscilloscope Input, select one of the following:

2 kHz/div	4 kHz/div	10 kHz/div
20 kHz/div		

For Func Gen or Ext Mod Oscilloscope Input, select one of the following:

500 mV/div	1 V/div	2.5 V/div
------------	---------	-----------

Blank for Oscilloscope Input set to Rcvr IF or Demod Audio (with Receiver Modulation set OFF or BFO).

Fixed at 13% MOD and 5 RAD for Oscilloscope Input set to Demod Audio with Receiver Modulation set to AM and PM, respectively.

Fixed at 4 V/div for Oscilloscope Input SINAD/BER.

For RF Pwr Lvl Oscilloscope Input, Scale Factor is replaced with 100 mW Rng or 50 W Rng. Power Meter Ranges\* of 20, 50 or 100 mW set Oscilloscope Scale to 100 mW Rng. All other Power Meter Ranges\* set Scale Factor to 50 W Rng.

\* RF Power Meter works with two primary ranges: 100 mW and 50 W. The field labeled "Range" on the Power Meter Operation screen also represents the current meter scale used within the primary ranges.

## MENU ITEM

## DESCRIPTION

3. Sweep Rate

Selects Oscilloscope Sweep Rate. Select one of the following:

1 $\mu$ s	2 $\mu$ s	5 $\mu$ s
10 $\mu$ s	20 $\mu$ s	50 $\mu$ s
100 $\mu$ s	200 $\mu$ s	500 $\mu$ s
1 ms	2 ms	5 ms
10 ms	20 ms	50 ms
100 ms		

4. Trig Mode

Selects Trigger Mode. Select One Shot, Normal or Auto.

5. Trig Lvl Setting

Selects Trigger Level. Range is 0 to 255; 0 signifying the bottom of the Oscilloscope grid, and 255 signifying the top.

6. Vert Offset

Selects vertical Trace Level. Range is 0 to 255; 0 signifying the bottom of the Oscilloscope grid, and 255 signifying the top.

7. Horiz Offset

Adjusts horizontal position of Oscilloscope Trace to allow viewing of pre-trigger and post-trigger information. Select -12 to +12 divisions.

### 3-3-8 SPECTRUM ANALYZER OPERATION SCREEN

Press SCOPE/ANLZ MODE Key to access the Spectrum Analyzer Operating Screen. Both the Spectrum Analyzer and Oscilloscope are accessed with the SCOPE/ANLZ MODE Key, if necessary, press SCOPE/ANLZ MODE Key twice to access the Spectrum Analyzer Operation Screen. The operation of the Spectrum Analyzer may be controlled by changing Screen Parameters, using Soft Function Keys or Setup Menus.

The following Screen Parameters portion identifies the operation screen parameters that are edited, the value range available and/or usage of each feature. When editing, use the FIELD SELECT Keys to move the cursor to the parameter to be edited and press ENTER Key to access the data field. Use the DATA ENTRY Keypad to enter numerical data. Use the DATA SCROLL Spinner or DATA SCROLL ↑ and ↓ Keys to select parameters from a list. Parameters with only two possible settings automatically switch to the opposite setting when selected.

#### A. SCREEN PARAMETERS

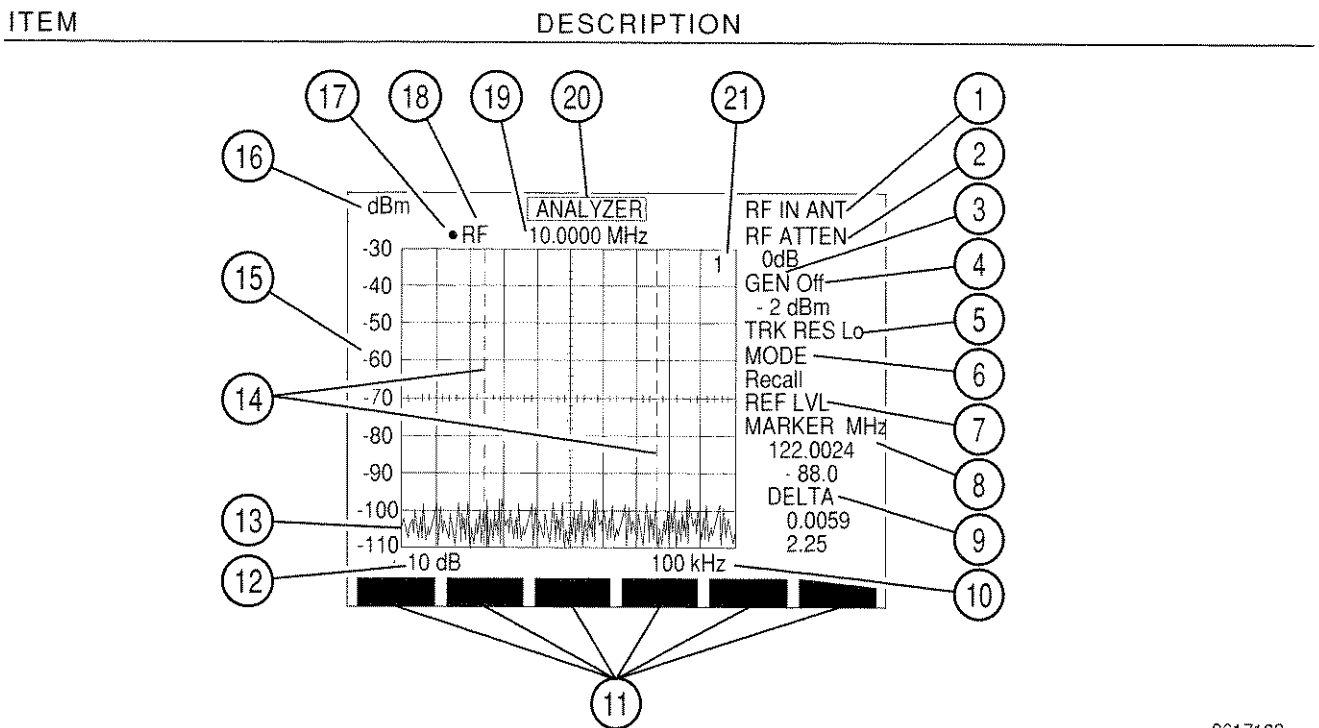

8617103

1. RF IN

Selects "ANT" (ANTENNA IN) or "T/R" Connector for RF Input Source.

2. RF ATTEN

Selects RF Input Attenuation Level. Select one of the following:

- |       |       |       |
|-------|-------|-------|
| 0 dB  | 5 dB  | 10 dB |
| 15 dB | 20 dB | 25 dB |
| 30 dB | LNA*  |       |

\*LNA (Low Noise Amplifier) has the same attenuation as 0 dB, but LNA has a lower noise figure. (**NOTE:** LNA is the preferred option for doing off-the-air applications.)

## ITEM

## DESCRIPTION

3. GEN

Selects Tracking Generator Output Level. The Tracking Generator Output Level range for corresponding input source and units is as follows:

UNITS	RF INPUT SOURCE	
	T/R	ANTENNA
dBm	-137.0 to 0.0 dBm	-120.0 to 10.0 dBm
Volts	0.031 $\mu$ V to 0.224 V	0.224 $\mu$ V to 0.707 V

4. Tracking Generator Output Connector

Selects Tracking Generator Output Connector. Toggles between T/R and DPL (DUPLEX OUT Connector). "OFF" is displayed when Tracking Generator is off.

5. TRK RES

Selects Tracking Generator Resolution. Select Lo, Me or Hi resolution. Lo allows trace to sweep faster with less resolution, Hi gives a slower sweep with greater trace accuracy and Me is a average of Lo and Hi.

6. MODE

Selects Analyzer Operation Mode. Select Live, Recall (recalls a stored set of parameters with Trace), Compare (compares Live Trace with Recalled Trace), Peak Hold or Average.

7. REF LVL

Appears when 2 dB/div Scale is selected. Adjusts vertical reference of Analyzer Trace using DATA SCROLL Spinner. Analyzer Grid Vertical Scale changes to reflect different reference.

8. MARKER

Access turns active Marker on. Displays Analyzer RF Frequency plus Marker adjustment. With Marker on, Trace amplitude value at Marker crossing appears below Marker reading in Analyzer Grid Units.

9. DELTA

Upper Reading provides readout of frequency difference between Markers. Lower Reading provides difference in signal amplitude between Markers.

ITEM	DESCRIPTION																		
10. <u>Scan Width</u>	Selects Zero Scan (0 kHz) or one of the following:																		
	<table> <tr> <td>1 kHz</td> <td>2 kHz</td> <td>5 kHz</td> </tr> <tr> <td>10 kHz</td> <td>20 kHz</td> <td>50 kHz</td> </tr> <tr> <td>100 kHz</td> <td>200 kHz</td> <td>500 kHz</td> </tr> <tr> <td>1 MHz</td> <td>2 MHz</td> <td>5 MHz</td> </tr> <tr> <td>10 MHz</td> <td>20 MHz</td> <td>50 MHz</td> </tr> <tr> <td>100 MHz</td> <td>200MHz</td> <td></td> </tr> </table>	1 kHz	2 kHz	5 kHz	10 kHz	20 kHz	50 kHz	100 kHz	200 kHz	500 kHz	1 MHz	2 MHz	5 MHz	10 MHz	20 MHz	50 MHz	100 MHz	200MHz	
1 kHz	2 kHz	5 kHz																	
10 kHz	20 kHz	50 kHz																	
100 kHz	200 kHz	500 kHz																	
1 MHz	2 MHz	5 MHz																	
10 MHz	20 MHz	50 MHz																	
100 MHz	200MHz																		
11. <u>Soft Function Keys</u>	Soft Function Keys for the Spectrum Analyzer Operation Screen are covered in 3-3-8B.																		
12. <u>Units/Division Factor</u>	Toggles Units/Division Factor between 2 and 10 dB/div.																		
13. <u>Analyzer Trace</u>	Spectrum Analyzer Trace displays visual readout of amplitude versus frequency of measured input.																		
14. <u>Markers</u>	When Markers are on, two vertical graduated markers appear on the screen.																		
15. <u>Analyzer Vertical Scale</u>	Vertical Scale displays in Analyzer Scale Units. Numeric vertical scale is dependent on Units/Division Factor.																		
16. <u>Analyzer Scale Units</u>	For "ANT" selected as RF IN, select dB $\mu$ W, dBm, dBV, dBmV or dB $\mu$ V. For "T/R" selected as RF IN, select dBW or dBm.																		
17. <u>Squelch Indicator Light</u>	Green dot appears when squelch is broken.																		
18. <u>RF</u>	Selects frequency or cellular channel of RF Frequency. See Figure 3-3. Spectrum Analyzer is forced into Direct Mode at a RF Frequency of 1005 MHz if Scan Width is 200 MHz.																		

ITEM	DESCRIPTION
19. <u>RF Frequency</u>	Displays RF Frequency or Cellular Channel setting. See Figure 3-3.
20. <u>ANALYZER</u>	Displays Oscilloscope Operation Screen when ANALYZER callout is accessed.
21. <u>Recall Trace Number</u>	Displays number of Recalled Trace. Displayed in Compare and Recall Modes only.

**B. SOFT FUNCTION KEYS**

The following index lists the sets of Soft Function Keys available for the Spectrum Analyzer Operation Screen.

ITEM	DESCRIPTION
22.	"More"/"ESC" Soft Function Key F6
23.	"Sp Tst" Soft Function Key F5
24.	"Atten" Soft Function Key F4
25.	"T/R"/"Ant" Soft Function Key F3
26.	"Scale" Soft Function Key F2
27.	"Mode" Soft Function Key F1

03416121

22. "More"/"ESC" Soft Function Key F6

"ESC" appears while parameters are accessed for editing. Allows edit procedure to be canceled without changing parameter. "More" displays additional sets of Soft Function Keys.

23. "Sp Tst" Soft Function Key F5

Displays Dual Mode IS-136 Cellular Menu.

24. "Atten" Soft Function Key F4

Selects RF Input Attenuation. See "RF ATTEN" Screen Parameter.

25. "T/R"/"Ant" Soft Function Key F3

Toggles RF Input Source between "T/R" and "ANT" (ANTENNA IN).

26. "Scale" Soft Function Key F2

Selects Analyzer Grid Scale. For "ANT" selected as RF IN, select dBμW, dBm, dBV, dBmV or dBμV. For "T/R" selected as RF IN, select dBW or dBm.

27. "Mode" Soft Function Key F1

Selects Analyzer Operation Mode. Select Live, Recall, Compare, Peak Hold or Average.



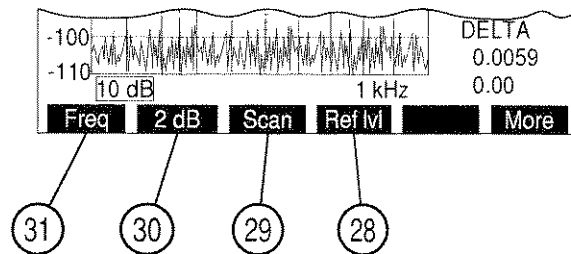

8617105

28. "Ref lvl" Soft Function Key F4

Appears with 2 dB/div Units/Division Factor. Adjusts vertical reference of Analyzer Trace using DATA SCROLL Spinner. Analyzer Vertical Scale changes to reflect different reference.

29. "Scan" Soft Function Key F3

Selects Analyzer Scan Width. Select zero scan (0 kHz) or one of the following:

1 kHz	2 kHz	5 kHz
10 kHz	20 kHz	50 kHz
100 kHz	200 kHz	500 kHz
1 MHz	2 MHz	5 MHz
10 MHz	20 MHz	50 MHz
100 MHz	200 MHz	

30. "2 dB"/"10 dB" Soft Function Key F2

Toggles Units/Division Factor between 2 and 10 dB/div.

31. "Freq" Soft Function Key F1

Selects RF Frequency or Channel. Unavailable when scan width is 200 MHz. For Direct Mode, select 0.2500 to 2010.0000 MHz. For Channel Mode, select 1 to 2047, depending on channel format. RF Frequency is forced to 1005 MHz if Scan Width is 200 MHz.

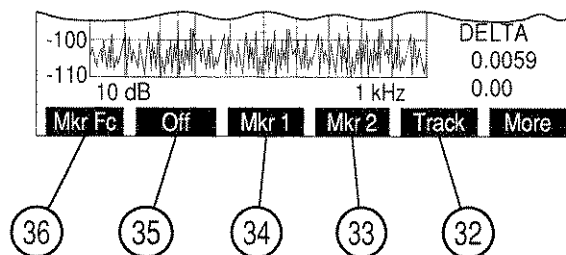

8617059

32. "Track" Soft Function Key F5

Activates Marker Tracking and edits the Markers position. Tracking locks Markers a constant distance apart. Marker positions are changed using the DATA SCROLL Spinner. With Tracking on, MARKER reading displays Marker 1 frequency position and DELTA reading remains constant.

ITEM	DESCRIPTION
------	-------------

33. "Mkr 2" Soft Function Key F4

Selects Marker 2 as the active marker. Accessing MARKER edits Marker 2 position when Marker 2 is active. "Mkr 2" appears in red while Marker 2 is active. Deactivate by pressing "Mkr 1", "Track" or "Off" Soft Function Key. Marker 2 remains visible while inactive unless "Off" is chosen.

34. "Mkr 1" Soft Function Key F3

Selects Marker 1 as the active marker. Accessing MARKER edits Marker 1 position unless Marker 2 is active. "Mkr 1" appears in red while Marker 1 is active. Deactivate by pressing "Mkr 2", or "Off" Soft Function Key. Marker 1 remains visible while inactive unless "Off" is chosen.

35. "Off" Soft Function Key F2

Turns Markers Off. When pressed, Markers are removed from the Analyzer display.

36. "Mkr Fc" Soft Function Key F1

Appears when a Marker is active. Resets RF Frequency to the active Marker frequency.

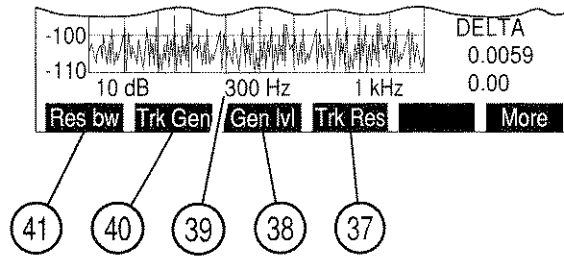

8617063

37. "Trk Res" Soft Function Key F4

Selects Analyzer Trace resolution. Select HI (high), ME (medium) or LO (low). High resolution produces a more accurate display, low resolution causes the Trace to sweep faster.

38. "Gen lvl" Soft Function Key F3

Selects Tracking Generator Output Level. The Tracking Generator Output Level range for corresponding input source and units is as follows:

	RF INPUT SOURCE	
UNITS	T/R	ANTENNA
dBm	-137.0 to 0.0 dBm	-120.0 to 10.0 dBm
Volts	0.031 $\mu$ V to 0.224 V	0.224 $\mu$ V to 0.707 V

39. Resolution Bandwidth Setting

Appears if Tracking Generator is on. Selects Resolution Bandwidth. Select 300 Hz, 3 kHz, 30 kHz, 300 kHz or 3 MHz.

ITEM	DESCRIPTION
------	-------------

40. "Trk Gen" Soft Function Key F2

Toggles Tracking Generator On or Off. Tracking Generator Output Connector is displayed when Tracking Generator is active, "OFF" is displayed when Tracking Generator is off.

41. "Res bw"/"Norm" Soft Function Key F1

- If Tracking Generator is on, "Res bw" is shown. Selects Resolution Bandwidth. Select 300 Hz, 3 kHz, 30 kHz, 300 kHz or 3 MHz.
- When Tracking Generator is off, "Norm" is shown. Access normalizes the Analyzer Trace on the Analyzer Grid to match the RF Generator Output.

The following set of Soft Function Keys appear if Tracking Generator is off.

ITEM	DESCRIPTION
------	-------------

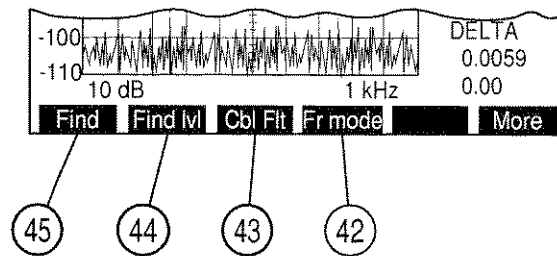

8607062

42. "Fr mode" Soft Function Key F4

Selects Spectrum Analyzer Frequency Mode. Toggles between Direct or Channel. Unavailable when scan width is 200 MHz.

43. "Cbl Flt" Soft Function Key F3

Starts Cable Fault Operation. Cable Fault determines the distance to point of fault in a cable and displays this length. "Cbl Flt" is displayed in red when active.

44. "Find lvl" Soft Function Key F2

Sets Find Reference Level used in the Find Function. When accessed, a red horizontal line appears displaying the Find Reference Level.

45. "Find" Soft Function Key F1

Blank when Cable Fault is active. When activated, finds the first frequency containing a signal with an amplitude greater than the Find Reference Level. Range of the Find Function is 4.0000 to 2010.0000 MHz. Find Function is inoperable when Scan Width is 200 MHz.

### C. SCOPE/ANALYZER (SPECTRUM ANALYZER) MENU

When Spectrum Analyzer Operation Screen is displayed, press the SETUP Key to access Scope/Analyzer Menu.

**NOTE:** Only one of the "1. Scope" and "2. Analyzer" Menu items can be on at a time, yet both may be turned off.

MENU ITEM	DESCRIPTION
-----------	-------------

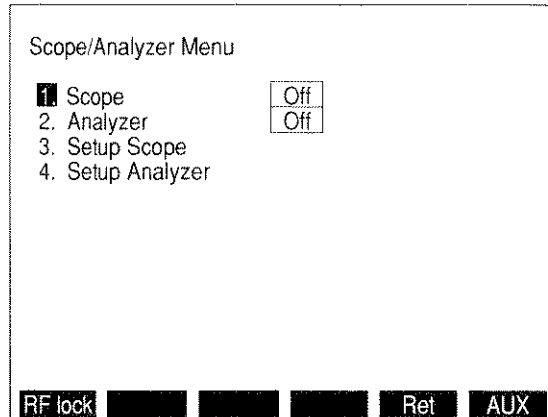

8610018

#### 1. Scope

Selects Oscilloscope display for RF Generator, Receiver, Duplex Transmitter and Duplex Receiver Operation Screens. Select On or Off.

#### 2. Analyzer

Selects Spectrum Analyzer display for RF Generator, Receiver, Duplex Transmitter and Duplex Receiver Operation Screens. Select On or Off.

#### 3. Setup Scope

Not applicable for Spectrum Analyzer Operation.

#### 4. Setup Analyzer

Displays Setup Analyzer Menu.

#### 5. "Chan"/"RF lock" Soft Function Key F1

- "Chan" Soft Function Key F1 is displayed when Channel is selected as the Spectrum Analyzer Frequency Mode. Displays Spectrum Analyzer Channel Format Menu.
- "RF lock" Soft Function Key F1 is displayed when Direct is selected as the Spectrum Analyzer Frequency Mode. Activates the RF Lock Function, locking the Analyzer RF Frequency to the RF Generator Frequency and the Receiver RF Frequency. Last frequency entered from among the three frequencies locked is the frequency locked on. "RF lock" appears in red when RF lock function is active.

When "4. Setup Analyzer" is selected the Analyzer Setup Menu appears:

MENU ITEM	DESCRIPTION
-----------	-------------

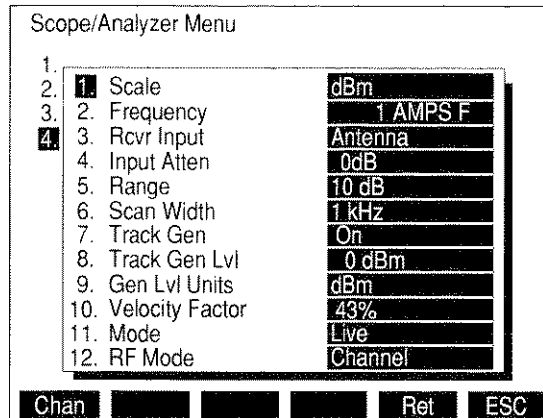

8610327

1. Scale

Selects Vertical Scale Grid. Select dBμW, dBm, dBV, dBmV or dBμV for ANTENNA IN Connector RF Input. Select dBm or dBW for T/R Connector RF Input.

2. Frequency

Selects RF Frequency or Cellular Channel. For a Frequency Mode, select 0.2500 to 2010.0000 MHz. For Channel Mode, select 1 to 2047, depending on channel format.

3. Rcvr Input

Selects Analyzer Input Connector. Select ANTENNA IN or T/R Connector.

4. Input Atten

Selects Input RF Attenuation. See "RF ATTEN" Screen Parameter.

5. Range

Selects Units/Division Factor. Select 2 or 10 dB.

6. Scan Width

Selects Analyzer Scan Width. Select Zero Scan (0 kHz) or one of the following:

1 kHz	2 kHz	5 kHz
10 kHz	20 kHz	50 kHz
100 kHz	200 kHz	500 kHz
1 MHz	2 MHz	5 MHz
10 MHz	20 MHz	50 MHz
100 MHz	200 MHz	

7. Tracking Gen

Toggles Tracking Generator On or Off.

**MENU ITEM**

**DESCRIPTION**

8. Tracking Gen Lvl

Selects Tracking Generator Output Level. The Tracking Generator Output Level range for corresponding input source and units is as follows:

UNITS	RF INPUT SOURCE	
	T/R	ANTENNA
dBm	-137.0 to 0.0 dBm	-120.0 to 10.0 dBm
Volts	0.031 $\mu$ V to 0.224 V	0.224 $\mu$ V to 0.707 V

9. Gen Lvl Units

Toggles Tracking Generator Level Units to dBm or volts.

10. Velocity Factor

Selects Velocity Factor for Cable Fault Operation. Range is 0.0% to 100%.

11. Mode

Selects Analyzer Operation Mode. Select Live, Recall (recalls a stored set of parameters with Trace), Compare (compares Live Trace with Recalled Trace), Average or Peak Hold.

12. RF Mode

Selects Spectrum Analyzer RF operation mode. Toggles between Direct and Channel. "Chan" Soft Function Key F1 appears when Channel Mode is selected. When the "Chan" Soft Function Key F1 is selected, the Spectrum Analyzer Channel Format Menu appears listing available Cellular Channel Formats:

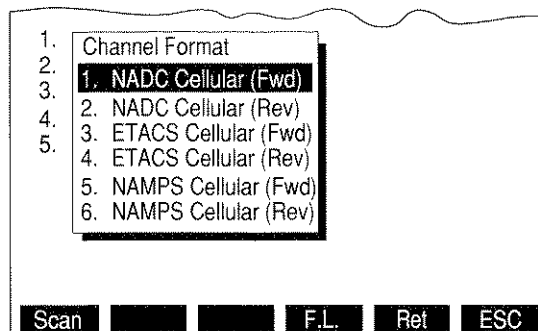

03416004

MENU ITEM

DESCRIPTION

If an NADC Cellular channel format is selected, the NADC Cellular format menu appears:

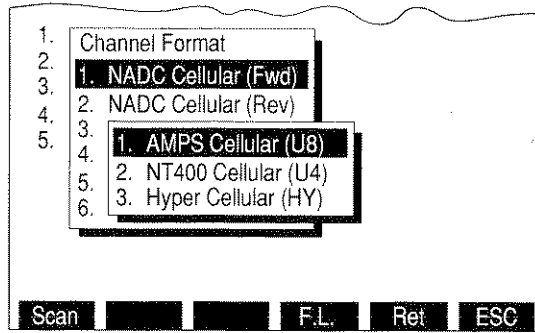

03416005

The operator may select AMPS, NT400® or Hyperband channel format.

### 3-3-9 METER OPERATION SCREENS AND MENUS

Each meter has an operation screen and a setup menu. Meter Operation Screens are accessed from other Operation Screens by moving the cursor to the Meter Callout and pressing the ENTER Key. When a Meter Operation Screen is accessed from another operation screen, the operator returns to that screen by pressing "Ret" Soft Function Key F6.

Direct access to meters is made through the Meter Menu. Press the MTRS MODE Key to display the Meter Menu. Access the desired Meter Operation Screen by pressing the indicated DATA ENTRY Key or by moving the menu highlight to the desired menu number and pressing the ENTER Key. Setup Menus for each meter are accessed by pressing the SETUP Key.

Many meter parameters are accessed or enabled from the Meter Operation Screen but some are only accessed from the setup menu for that meter. Use FIELD SELECT Keys to move the Meter Operation Screen cursor to the parameter to be edited and press the ENTER Key to access the data field or to enable or disable the feature. Use the DATA ENTRY Keypad to enter numeric data. Use the DATA SCROLL Spinner or DATA SCROLL ↑ and ↓ Keys to select from lists. Parameters with only two possible settings automatically toggle to the opposite setting when selected.

Use the index of meter parameters on the following pages to identify the parameters which are edited from the Meter Operation Screens and which must be edited from the individual meter's setup menu:

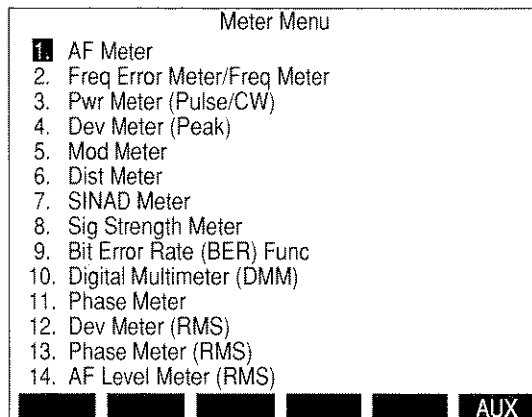

8616012



## A. AF METER OPERATION SCREEN

With the Meter Menu displayed, press 1 DATA ENTRY Key to access the AF Meter Operation Screen:

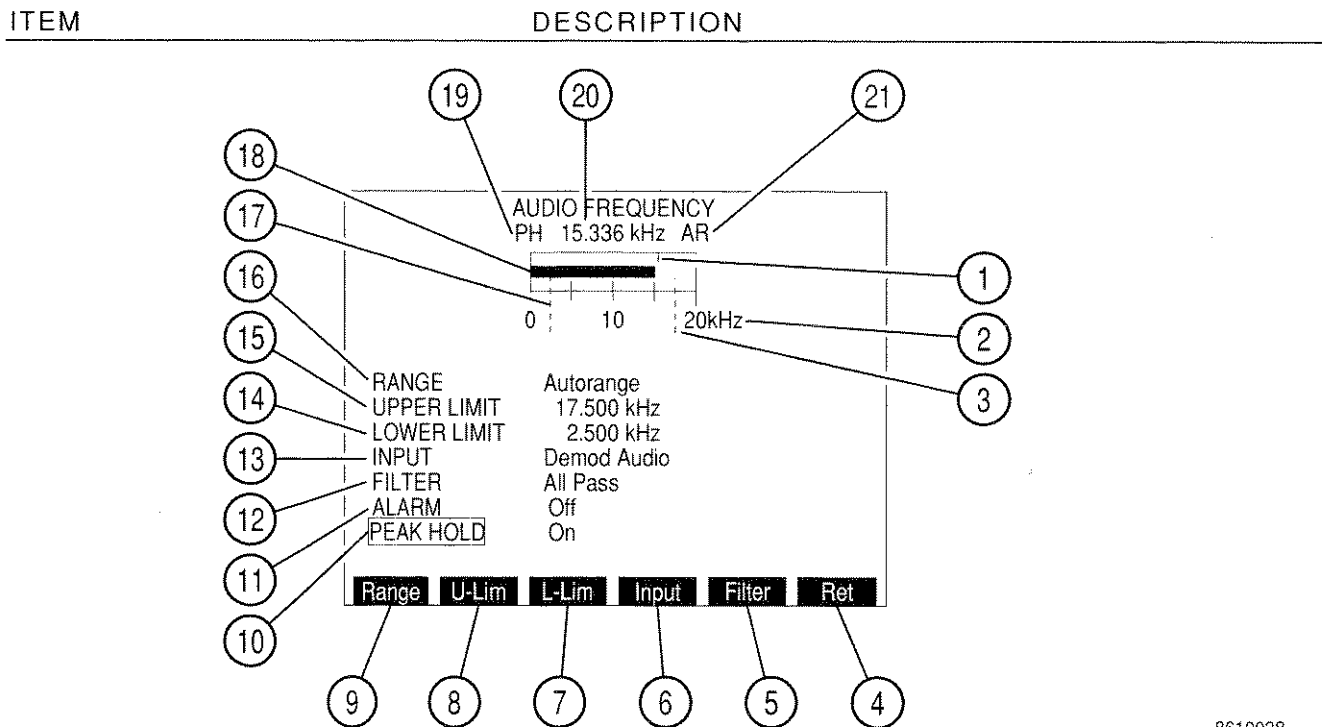

8610038

### 1. Peak Hold Indicator

Appears when PEAK HOLD is On. Indicator line shows highest point of meter deflection.

### 2. Meter Range Scale

Meter scale of four divisions is marked from 0 to the limits of the active scale with center division labeled with the midpoint of the range.

### 3. Upper Limit Indicator

When Upper Limit feature is On, a dotted blue line appears across the meter window at the point on the scale where the limit is set. The indicator appears at the right edge of the meter window if the limit is set higher than the meter range.

### 4. "Ret"/"ESC" Soft Function Key F6

When editing a parameter, "ESC" is shown. Stops editing process and voids any changes to parameter. "Ret" returns operation to the screen from which meter was called.

ITEM	DESCRIPTION
5. <u>"Filter" Soft Function Key F5</u>	Selects AF Filter. Select All Pass, Low-Pass or High-Pass. Cutoff frequencies are set from AF Meter Menu.
6. <u>"Input" Soft Function Key F4</u>	Selects AF Meter Input. Select Ext Mod (EXT MOD IN Connector), Demod Audio, Func Gen Out, SINAD/BER (SINAD/BER IN Connector) or RF Power.
7. <u>"L-Lim" Soft Function Key F3</u>	Activates Lower Limit and selects Lower Limit value. Range is 0.000 to 200.0 kHz. Lower Limit is deactivated from AF Meter Menu.
8. <u>"U-Lim" Soft Function Key F2</u>	Activates Upper Limit and selects Upper Limit value. Range is 0.000 to 200.0 kHz. Upper Limit is deactivated from AF Meter Menu.
9. <u>"Range" Soft Function Key F1</u>	Selects AF Meter Range. Select Autorange, 200 Hz, 2 kHz, 20 kHz or 200 kHz.
10. <u>PEAK HOLD</u>	Toggles Peak Hold On or Off.
11. <u>ALARM</u>	Toggles Alarm between Off and On. Enabled Alarm sounds when Upper or Lower Limit is exceeded.
12. <u>FILTER</u>	Selects AF Filter. Select All Pass, Low-Pass or High-Pass. Cutoff frequencies are set from AF Meter Menu.
13. <u>INPUT</u>	Selects AF Meter Input. Select Ext Mod (EXT MOD IN Connector), Demod Audio, Func Gen Out, SINAD/BER (SINAD/BER IN Connector) or RF Power.
14. <u>LOWER LIMIT</u>	Activates Lower Limit and selects Lower Limit value. Range is 0.000 to 200.0 kHz. Lower Limit is deactivated from AF Meter Menu. An asterisk indicates that the currently displayed value is invalid. Invalid limit values can be caused by changing Range Units.

ITEM	DESCRIPTION
15. <u>UPPER LIMIT</u>	Activates Upper Limit and selects Upper Limit value. Range is 0.000 to 200.0 kHz. Upper Limit is deactivated from AF Meter Menu. An asterisk indicates that the currently displayed value is invalid. Invalid limit values can be caused by changing Range Units.
16. <u>RANGE</u>	Selects AF Meter Range. Select Autorange, 200 Hz, 2 kHz, 20 kHz or 200 kHz.
17. <u>Lower Limit Indicator</u>	When the Lower Limit feature is On, a dotted blue line appears across the meter window at the point on the scale where the limit is set.
18. <u>Meter Indicator Bar</u>	Displays Frequency Error reading. Bar turns red if Upper or Lower Limit is exceeded. Bar turns green if the maximum of the current range is reached.
19. <u>PH</u>	Appears above left corner of the meter window if PEAK HOLD is On.
20. <u>Digital Meter Readout</u>	Provides digital readout of the meter indication. Readout shows highest meter indication reached when PEAK HOLD is On.
21. <u>AR</u>	Appears above upper right corner of the meter window when Autorange is selected for RANGE. The Meter Range Scale changes to the next higher scale when meter indicator reaches the edge of the meter window. Range changes to the next lower scale if the meter indicator falls to a level of about 1/2 of the lowest scale division.

With the AF Meter Operation Screen displayed, press the SETUP Key to access the AF Meter Menu:

MENU ITEM

DESCRIPTION

AF Meter Menu	
1. Select AF Meter In	Demod Audio
2. Select Filter	All Pass
3. Meter Range	Autorange
4. Gate Time	1 Second
5. Select Peak Hold	On
6. Upper Lmt	On
7. Set Upper Lmt	17.500 kHz
8. Lower Lmt	On
9. Set Lower Lmt	2.500 kHz
10. Set Alarm	Off

8610002

1. Select AF Meter In

Selects AF Meter Input. Select Ext Mod (EXT MOD IN Connector), Demod Audio, Func Gen Out, SINAD/BER (SINAD/BER IN Connector) or RF Power.

2. Select Filter

Selects AF Meter Filter. Select All Pass, Low-Pass or High-Pass. If Low-Pass or High-Pass is selected, a data field appears allowing entry of the cutoff frequency. Range is 0.1 to 30 kHz for the Low-Pass cutoff frequency, 0.5 to 20 kHz for the High-Pass cutoff frequency.

3. Meter Range

Selects AF Meter Range. Select Autorange, 200 Hz, 2 kHz, 20 kHz or 200 kHz.

4. Gate Time

Toggles Gate Time to 1 or 10 sec. Longer Gate Times produce more accurate slower readings.

5. Select Peak Hold

Toggles Peak Hold On or Off.

6. Upper Lmt

Toggles Upper Limit On or Off.

7. Set Upper Lmt

Selects Upper Limit Level. Range is 0.000 to 200.0 kHz. An asterisk indicates that the currently displayed value is invalid. Invalid limit values can be caused by changing Range Units.

MENU ITEM	DESCRIPTION
8. <u>Lower Lmt</u>	Toggles Lower Limit On or Off.
9. <u>Set Lower Lmt</u>	Selects Lower Limit Level. Range is 0.000 to 200.0 kHz. An asterisk indicates that the currently displayed value is invalid. Invalid limit values can be caused by changing Range Units.
10. <u>Set Alarm</u>	Toggles Alarm On or Off. Enabled Alarm sounds when an Upper or Lower Limit is exceeded.

## B. FREQUENCY ERROR METER

With the Meter Menu displayed, press 2 DATA ENTRY Key to access the Frequency Error Meter Operation Screen:

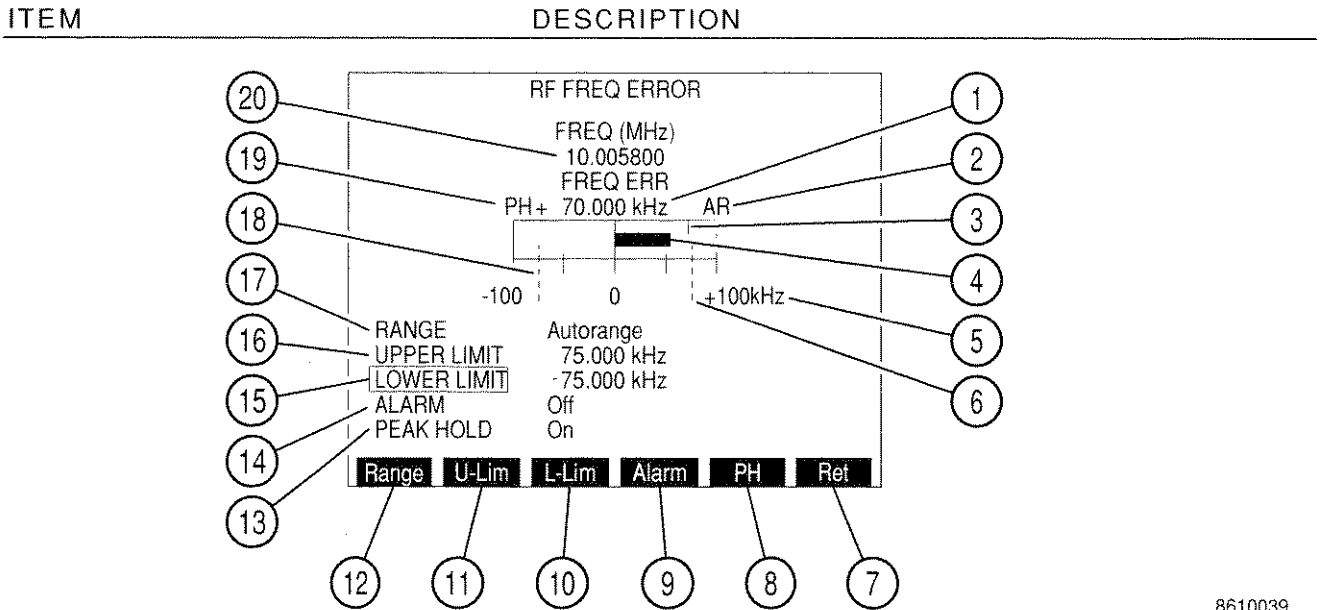

8610039

### 1. Frequency Error Digital Readout

Provides a digital readout of the difference between the Received Frequency and the Receiver Frequency Setting. Readout shows the highest meter indication reached when PEAK HOLD is On.

### 2. AR

Appears above upper right corner of the meter window when Autorange is selected for RANGE. The Meter Range Scale changes to the next higher scale when the Meter Indicator Bar reaches the edge of the meter window. The range changes to the next lower scale if the meter indicator bar falls to a level of about 1/2 of the lowest scale division.

### 3. Peak Hold Indicator

Appears when Peak Hold is On. Indicator line shows highest point of positive meter deflection when the Frequency Error is positive. When Frequency Error is negative, an indicator line appears in the negative half of the meter window and indicates the lowest point of negative meter deflection.

### 4. Meter Indicator Bar

Displays Frequency Error reading. Bar turns red if Upper or Lower Limit is exceeded. Bar turns green if the current range is surpassed.

ITEM	DESCRIPTION
5. <u>Meter Range Scale</u>	The meter scale of four divisions is marked from "-" the scale limit on the left to "+" the scale limit on the right. The center division of the scale is always marked 0.
6. <u>Upper Limit Indicator</u>	When Upper Limit feature is On, a dotted blue line appears across the meter window at the point on the scale where the limit is set. The line appears at the right edge of the meter window if the limit is set higher than the meter range. The Upper Limit is positive and appears on the right half of the meter window.
7. <u>"Ret"/"ESC" Soft Function Key F6</u>	When editing a parameter, "ESC" is shown. Stops editing process and voids any changes to parameter. "Ret" returns operation to the screen from which meter was called.
8. <u>"PH" Soft Function Key F5</u>	Toggles Peak Hold On or Off.
9. <u>"Alarm" Soft Function Key F4</u>	Toggles Alarm On or Off. Enabled Alarm sounds when Upper or Lower Limit is exceeded.
10. <u>"L-Lim" Soft Function Key F3</u>	Activates Lower Limit and selects Lower Limit value. Range is 0.000 to 100.000 kHz. Lower Limit is deactivated from Frequency Error Meter Menu.
11. <u>"U-Lim" Soft Function Key F2</u>	Activates Upper Limit and selects Upper Limit value. Range is 0.000 to 100.000 kHz. Upper Limit is deactivated from Frequency Error Meter Menu.
12. <u>"Range" Soft Function Key F1</u>	Selects Frequency Error Meter Range. Select Autorange, $\pm 100$ Hz, $\pm 1$ kHz, $\pm 10$ kHz or $\pm 100$ kHz.
13. <u>PEAK HOLD</u>	Toggles Peak Hold On or Off.
14. <u>ALARM</u>	Toggles Alarm On or Off. Enabled Alarm sounds when Upper or Lower Limit is exceeded.

ITEM	DESCRIPTION
15. <u>LOWER LIMIT</u>	Activates Lower Limit and selects Lower Limit value. Range is 0.000 to 100.000 kHz. Lower Limit is deactivated from Frequency Error Meter Menu. An asterisk indicates that the currently displayed value is invalid. Invalid limit values can be caused by changing Range Units.
16. <u>UPPER LIMIT</u>	Activates Upper Limit and selects Upper Limit value. Range is 0.000 to 100.000 kHz. Upper Limit is deactivated from Frequency Error Meter Menu. An asterisk indicates that the currently displayed value is invalid. Invalid limit values can be caused by changing Range Units.
17. <u>RANGE</u>	Selects Frequency Error Meter Range. Select Autorange, $\pm 100$ Hz, $\pm 1$ kHz, $\pm 10$ kHz or $\pm 100$ kHz.
18. <u>Lower Limit Indicator</u>	When Lower Limit feature is On, a dotted blue line appears across the meter window at the point on the scale where the limit is set. The line appears at the left edge of the meter window if Limit is set lower than the meter range. The Lower Limit is negative and appears on the left half of the meter window.
19. <u>PH</u>	Appears above left corner of the meter window if PEAK HOLD is On.
20. <u>Received Frequency Digital Readout</u>	Provides a digital readout of the received frequency in MHz.



With the Frequency Error Meter Operation Screen displayed, press the SETUP Key to access the RF Frequency Error Meter Menu:

MENU ITEM DESCRIPTION

RF Frequency Error Meter Menu	
1. Meter Range	Autorange
2. Gate Time	1 Second
3. Select Peak Hold	On
4. Upper Lmt	On
5. Set Upper Lmt	75.000 kHz
6. Lower Lmt	On
7. Set Lower Lmt	-75.000 kHz
8. Set Alarm	Off

8610003

1. Meter Range

Selects Frequency Error Meter Range. Select Autorange,  $\pm 100$  Hz,  $\pm 1$  kHz,  $\pm 10$  kHz or  $\pm 100$  kHz.

2. Gate Time

Toggles Gate Time between 0.1 and 1 second. Longer Gate Times produce more accurate slower readings.

3. Select Peak Hold

Toggles Peak Hold On or Off.

4. Upper Lmt

Toggles Upper Limit On or Off.

5. Set Upper Lmt

Selects Upper Limit Level. Range is 0.000 to 100.0 kHz. An asterisk indicates that the currently displayed value is invalid. Invalid limit values can be caused by changing Range Units.

6. Lower Lmt

Toggles Lower Limit On or Off.

7. Set Lower Lmt

Selects Lower Limit Level. Range is 0.000 to 100.0 kHz. Value is negative. An asterisk indicates that the currently displayed value is invalid. Invalid limit values can be caused by changing Range Units.

8. Set Alarm

Toggles Alarm On or Off. Enabled Alarm sounds when Upper or Lower Limit is exceeded.

### C. POWER METER

With the Meter Menu displayed, press 3 DATA ENTRY Key to access the Power Meter Operation Screen:

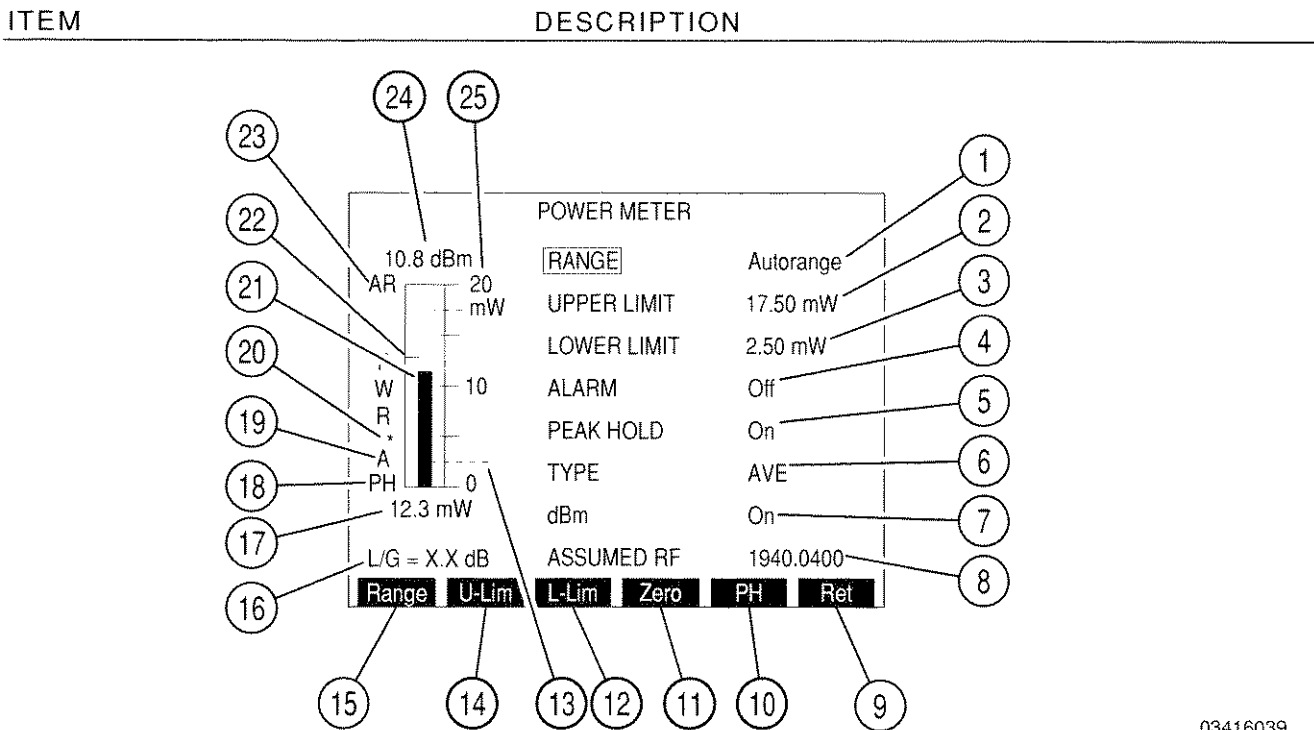

03416039

#### 1. RANGE

Selects Power Meter Range Scale within one of the two primary ranges: 100 mW and 50 W. Select one of the following:

- With External Loss/Gain (L/G) disabled.

20 mW	50 mW	100 mW
200 mW	500 mW	1 W
2 W	5 W	10 W
20 W	50 W	100 W
200 W	Autorange	

**NOTE:** RF Power Meter works with two primary ranges: 100 mW and 50 W. The RANGE field also represents the current meter scale used within the primary ranges.

- With External Loss/Gain (L/G) enabled:

EXT LOSS/ GAIN	-30.0 to -23.0 dB	-22.9 to -13.0 dB	-12.9 to -3.0 dB	-2.9 to 2.9 dB	3.0 to 12.9 dB	13.0 to 22.9 dB	3.0 to 30.0 dB
POWER METER RANGE	20 W	2 W	200 mW	20 mW	2 mW	200 $\mu$ W	20 mW
	50 W	5 W	500 mW	50 mW	5 mW	500 $\mu$ W	50 $\mu$ W
	100 W	10 W	1 W	100 mW	10 mW	1 mW	100 $\mu$ W
	200 W	20 W	2 W	200 mW	20 mW	2 mW	200 $\mu$ W
	500 W	50 W	5 W	500 mW	50 mW	5 mW	500 $\mu$ W
	1 kW	100 W	10 W	1 W	100 mW	10 mW	1 mW
	2 kW	200 W	20 W	2 W	200 mW	20 mW	2 mW
	5 kW	500 W	50 W	5 W	500 mW	50 mW	5 mW
	10 kW	1 kW	100 W	10 W	1 W	100 mW	10 mW
	20 kW	2 kW	200 W	20 W	2 W	200 mW	20 mW
	50 kW	5 kW	500 W	50 W	5 W	500 mW	50 mW
	100 kW	10 kW	1 kW	100 W	10 W	1 W	100 mW
	200 kW	20 kW	2 kW	200 W	20 W	2 W	200 mW
	Autorange	Autorange	Autorange	Autorange	Autorange	Autorange	Autorange

Table 3-4 External Loss/Gain

2. UPPER LIMIT

Activates Upper Limit and selects Upper Limit value. Range is 0.0 to 200.0 W. Upper Limit is turned Off from Power Meter Menu. An asterisk indicates that the currently displayed value is invalid. Invalid limit values can be caused by changing Range Units.

3. LOWER LIMIT

Activates Lower Limit and selects Lower Limit value. Range is 0.0 to 200.0 W. Lower Limit is turned Off from Power Meter Menu. An asterisk indicates that the currently displayed value is invalid. Invalid limit values can be caused by changing Range Units.

4. ALARM

Toggles alarm On or Off. Enabled alarm sounds when Upper or Lower Limit is exceeded.

5. PEAK HOLD

Toggles Peak Hold On or Off.

ITEM	DESCRIPTION
6. <u>TYPE</u>	Selects the type of power measurement performed. Select Peak, CW or AVE.
7. <u>dBm</u>	Toggles dBm readout On or Off. Readout appears above Meter Scale when On.
8. <u>ASSUMED RF</u>	Assumed RF Frequency (within 1 MHz) of signal measured. Range is 0.2500 to 2010.0000 MHz.
9. <u>"Ret"/"ESC" Soft Function Key F6</u>	When editing a parameter, "ESC" is shown. Stops editing process and voids any changes to parameters. "Ret" returns operation to the screen from which meter was called.
10. <u>"PH" Soft Function Key F5</u>	Toggles Peak Hold On or Off.
11. <u>"Zero" Soft Function Key F4</u>	Zeros Power Meter.
12. <u>"L-Lim" Soft Function Key F3</u>	Activates Lower Limit and selects Lower Limit value. Range is 0.0 to 200.0 W. Lower Limit is turned Off from Power Meter Menu.
13. <u>Lower Limit Indicator</u>	When Lower Limit is On, a dotted blue line appears across the meter window at the point on the scale where the Limit is set.
14. <u>"U-Lim" Soft Function Key F2</u>	Activates Upper Limit and selects Upper Limit value. Range is 0.0 to 200.0 W. Upper Limit is turned Off from Power Meter Menu.
15. <u>"Range" Soft Function Key F1</u>	When pressed, moves cursor to "RANGE" and activates data field. See operation screen Item "RANGE" for detailed description.
16. <u>L/G</u>	Displays only when External Loss/Gain is enabled. Displays the set value
17. <u>Digital Readout</u>	Displays digital readout of the Power Meter in W or mW.

ITEM	DESCRIPTION
18. <u>PH</u>	Appears at the lower left corner of the meter window when PEAK HOLD is On.
19. <u>Meter Type Indicator</u>	Indicates the Power Meter Type. Displays A (Average), C (Continuous) or P (Peak).
20. <u>Offset Indicator</u>	Displays asterisk when an External Loss/Gain is being used to calculate power reading. External Loss/Gain Offset is set from the Power Meter Setup Menu.
21. <u>Meter Indicator Bar</u>	Displays Power Meter reading. Bar turns red when an Upper or Lower Limit is exceeded. Bar turns green if the current range is surpassed.
22. <u>Peak Hold Indicator</u>	Appears when PEAK HOLD is On. Indicator line shows the highest point of meter deflection.
23. <u>AR</u>	Appears when Autorange is selected for RANGE. The Meter Range Scale changes to the next higher scale when the Meter Indicator Bar reaches the edge of the meter window. The range changes to the next lower scale if the Meter Indicator Bar falls to a level of about 1/2 of the lowest scale division.
24. <u>dBm Readout</u>	Appears when dBm is On. Provides a digital readout in dBm of the meter reading.
25. <u>Meter Range Scale</u>	The meter scale of four divisions is marked from 0 to the limits of the active scale with the center division labeled with the midpoint of the range.

With the Power Meter Operation Screen displayed, press the SETUP Key to access the Power Meter Menu:

MENU ITEM DESCRIPTION

Power Meter Menu	
1. Meter Range	Autorange
2. Measurement Type	CW
3. dBm Enable	On
4. Select Peak Hold	On
5. Upper Lmt	On
6. Set Upper Lmt	17.5 mW
7. Lower Lmt	On
8. Set Lower Lmt	2.5 mW
9. Set Alarm	Off
10. Ext Loss/Gain	On
11. Set Ext Loss/Gain	- 5.0 dB
12. Assumed RF Freq	1940.0400

03416157

1. Meter Range

Selects Power Meter Range Scale within one of the two primary ranges: 100 mW and 50 W. Select one of the following:

- With External Loss/Gain (L/G) disabled (see operation screen Item "L/G").

20 mW	50 mW	100 mW
200 mW	500 mW	1 W
2 W	5 W	10 W
20 W	50 W	100 W
200 W	Autorange	

- With External Loss/Gain (L/G) enabled (see Table 3-4).

2. Measurement Type

Selects the type of power measurement performed. Select Peak, CW or AVE.

3. dBm Enable

Toggles dBm digital readout On or Off.

4. Select Peak Hold

Toggles Peak Hold On or Off.

5. Upper Lmt

Toggles Upper Limit On or Off.

6. Set Upper Lmt

Select Upper Limit Level. Range is 0.0 mW to 200.0 W. An asterisk indicates that the currently displayed value is invalid. Invalid limit values can be caused by changing Range Units.

## MENU ITEM

## DESCRIPTION

7. Lower Lmt

Toggles Lower Limit On or Off.

8. Set Lower Lmt

Select Lower Limit Level. Range is 0.0 mW to 200.0 W. An asterisk indicates that the currently displayed value is invalid. Invalid limit values can be caused by changing Range Units.

9. Set Alarm

Toggles Alarm On or Off. Enabled Alarm sounds when Upper or Lower Limit is exceeded.

10. Ext Loss/Gain

Toggles External Loss/Gain Offset On or Off.

11. Set Ext Loss/Gain

Select External Loss/Gain Offset amount. Range is -30.0 to 30.0 dBm. Positive values lower Power Meter readings and compensate for external gains. Negative values raise Power Meter readings and compensate for external losses.

12. Assumed RF Freq

Select frequency (within 1 MHz) of RF signal measured. Range is 0.2500 to 2010.0000 MHz.

#### D. DEVIATION METER (PEAK)

With the Meter Menu displayed, press 4 DATA ENTRY Key to access the Deviation Meter (Peak) Operation Screen:

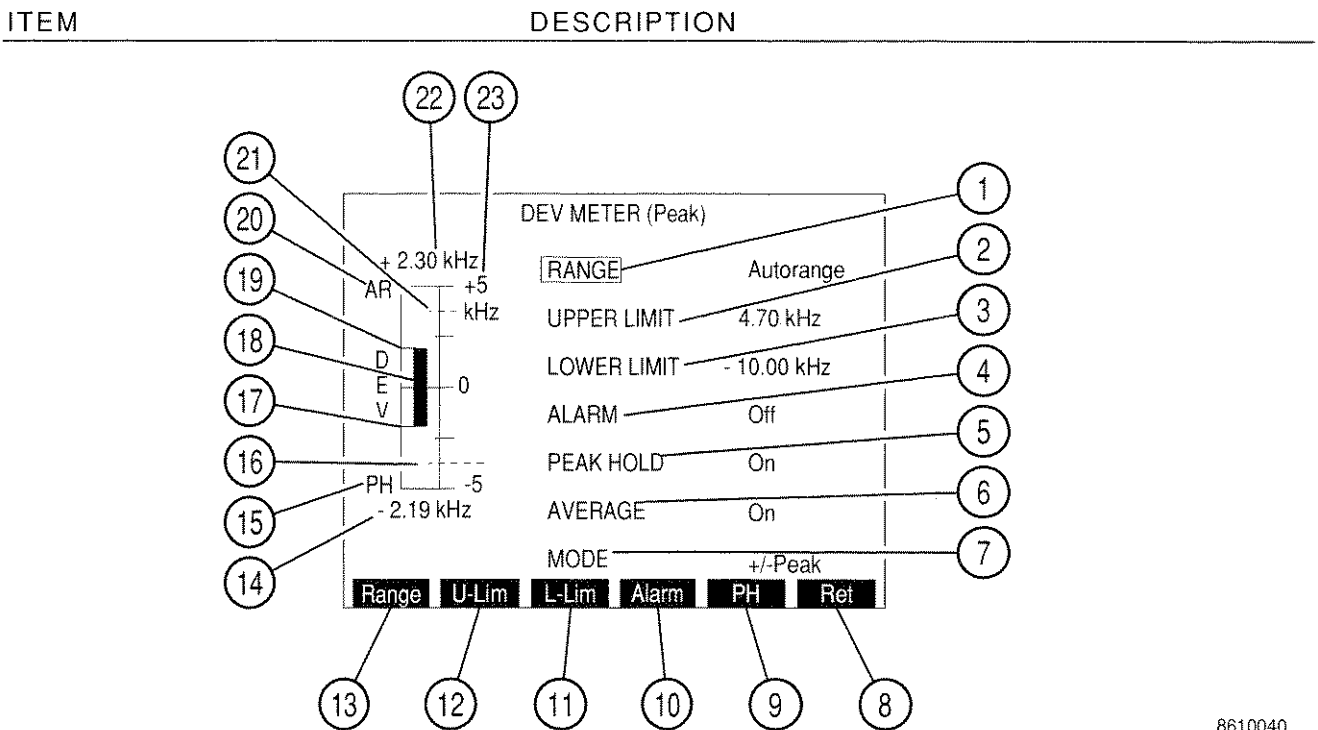

8610040

#### 1. RANGE

Selects Deviation Meter Range. Select Autorange, 2, 5, 10, 20, 50 or 100 kHz.

#### 2. UPPER LIMIT

Activates Upper Limit and selects Upper Limit value. Range is 0.0 to 100.0 kHz. Upper Limit is turned Off from Deviation Meter Menu.

#### 3. LOWER LIMIT

Activates Lower Limit and selects Lower Limit value. Range is 0.0 to 100.0 kHz. Lower Limit is turned Off from Deviation Meter Menu.

#### 4. ALARM

Toggles Alarm On or Off. Enabled Alarm sounds when Upper or Lower Limit is exceeded.

#### 5. PEAK HOLD

Toggles Peak Hold On or Off.



ITEM	DESCRIPTION
6. <u>AVERAGE</u>	Toggles Average feature On or Off. When On, Meter reads a running average of last 10 readings.
7. <u>MODE</u>	Selects Deviation Meter Mode. Select +Peak, -Peak, +/-Peak or +/-Peak/2. +Peak displays positive deviation readings only. -Peak displays negative deviation readings only. +/-Peak displays positive and negative deviation readings. +/-Peak/2 displays the average of the absolute values of positive and negative deviation readings.
8. <u>"Ret"/"ESC" Soft Function Key F6</u>	When editing a parameter, "ESC" is shown. Stops editing process and voids any changes to parameter. "Ret" returns operation to the screen from which meter was called.
9. <u>"PH" Soft Function Key F5</u>	Toggles Peak Hold On or Off.
10. <u>"Alarm" Soft Function Key F4</u>	Toggles Alarm On or Off.
11. <u>"L-Lim" Soft Function Key F3</u>	Activates Lower Limit and selects Lower Limit value. Range is 0.0 to 100.0 kHz. Lower Limit is deactivated from Deviation Meter Menu.
12. <u>"U-Lim" Soft Function Key F2</u>	Activates Upper Limit and selects Upper Limit value. Range is 0.0 to 100.0 kHz. Lower Limit is deactivated from Deviation Meter Menu.
13. <u>"Range" Soft Function Key F1</u>	Selects Deviation Meter Range. Select Autorange, 2, 5, 10, 20, 50 or 100 kHz.
14. <u>Negative Digital Readout</u>	Provides a digital readout of the positive deviation for + Peak and +/- Peak/2 Modes. Provides a digital readout of the negative deviation in kHz for - Peak and +/- Peak Modes.
15. <u>PH</u>	Appears at the lower left side of the meter window if PEAK HOLD is On.

ITEM	DESCRIPTION
16. <u>Lower Limit Indicator</u>	When the Lower Limit is On, a dotted blue line appears across the meter window at the point on the scale where the limit is set.
17. <u>Lower Peak Hold Indicator</u>	Appears when PEAK HOLD is On and in +/-Peak Mode. Indicates point of lowest negative Deviation Meter deflection.
18. <u>Meter Indicator Bar</u>	Displays Deviation Meter reading. Bar turns red when a Upper or Lower Limit is exceeded. Bar turns green if the current range is surpassed.
19. <u>Upper Peak Hold Indicator</u>	Appears when PEAK HOLD is On. Indicator line shows the highest point of positive Deviation Meter deflection.
20. <u>AR</u>	Appears at the upper right side of the meter window if the RANGE is set for Autorange. The Meter Range Scale changes to the next higher scale when the meter indicator reaches the edge of the meter window. The meter changes to the next lower scale if the meter indicator falls to a level of about 1/2 of the lowest scale division.
21. <u>Upper Limit Indicator</u>	When UPPER LIMIT is On, a dotted blue line appears across the meter window at the point on the scale where the limit is set.
22. <u>Positive Digital Readout</u>	Appears in +/-Peak Mode. Provides a digital readout of the positive deviation in kHz.
23. <u>Meter Range Scale</u>	Displays Meter Scale in four divisions.

With the Deviation Meter Operation Screen displayed, press the SETUP Key to access the Deviation Meter (Peak) Menu:

MENU ITEM DESCRIPTION

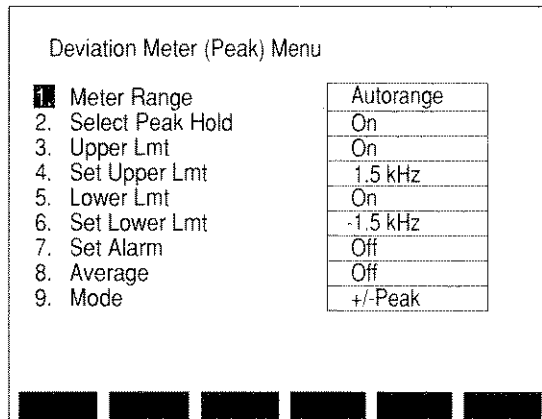

8610005

1. Meter Range

Displays submenu allowing the selection of the Deviation Meter Range. Select Autorange, 2, 5, 10, 20, 50 or 100 kHz.

2. Select Peak Hold

Toggles Peak Hold On or Off.

3. Upper Lmt

Toggles Upper Limit On or Off.

4. Set Upper Lmt

Selects Upper Limit Level. Range is 0.0 to 20.0 kHz.

5. Lower Lmt

Toggles Lower Limit On or Off.

6. Set Lower Lmt

Selects Lower Limit Level. Range is 0.0 to 20.0 kHz.

7. Set Alarm

Toggles Alarm On or Off. Enabled Alarm sounds when Upper or Lower Limit is exceeded.

8. Average

Toggles Average feature On or Off. When On, Meter reads a running average of last 10 readings.

MENU ITEM

DESCRIPTION

---

9. Mode

Selects Deviation Meter Mode. Select +Peak, -Peak, +/-Peak or +/-Peak/2.  
+Peak displays positive deviation readings only. -Peak displays negative deviation readings only. +/-Peak displays positive and negative deviation readings.  
+/-Peak/2 displays absolute value of the average of positive and negative deviation readings.

## E. MODULATION METER

With the Meter Menu displayed, press 5 on the DATA ENTRY Keypad to access the Modulation Meter Operation Screen:

ITEM	DESCRIPTION
------	-------------

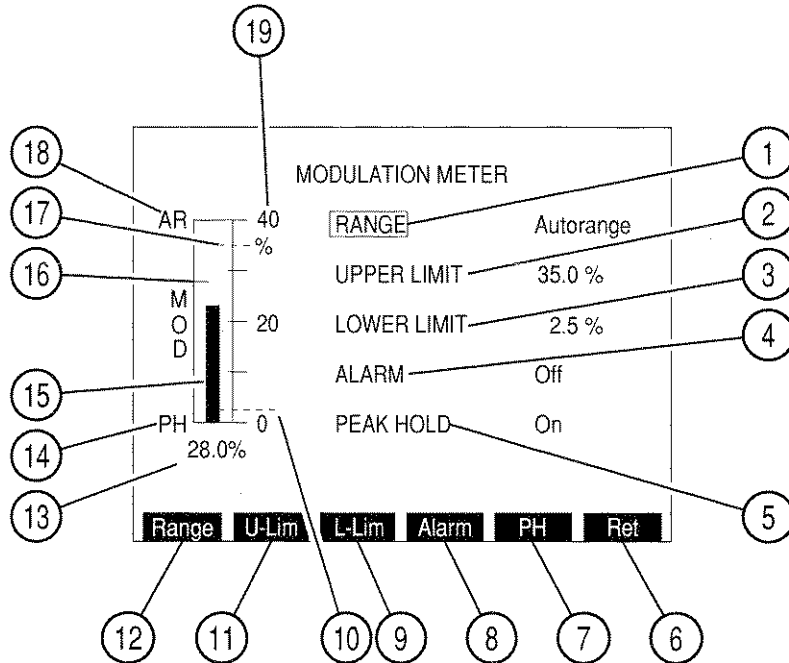

8610042

### 1. RANGE

Selects Modulation Meter Range. Select Autorange, 40% or 100%.

### 2. UPPER LIMIT

Activates Upper Limit and selects Upper Limit value. Range is 0.0% to 100.0%. Upper Limit is turned Off from the Modulation Meter Menu.

### 3. LOWER LIMIT

Activates Lower Limit and selects Lower Limit value. Range is 0.0% to 100.0%. Lower Limit is turned Off from Modulation Meter Menu.

### 4. ALARM

Toggles Alarm On or Off. Enabled Alarm sounds when Upper or Lower Limit is exceeded.

### 5. PEAK HOLD

Toggles Peak Hold On or Off.

ITEM	DESCRIPTION
6. <u>"Ret"/"ESC" Soft Function Key F6</u>	When editing a parameter, "ESC" is shown. Stops editing process and voids any changes to parameter. "Ret" returns operation to the screen from which meter was called.
7. <u>"PH" Soft Function Key F5</u>	Toggles Peak Hold On or Off.
8. <u>"Alarm" Soft Function Key F4</u>	Toggles Alarm On or Off. Enabled Alarm sounds when Upper or Lower Limit is exceeded.
9. <u>"L-Lim" Soft Function Key F3</u>	Activates Lower Limit and selects Lower Limit value. Range is 0.0% to 100.0%. Lower Limit is turned Off from Modulation Meter Menu.
10. <u>Lower Limit Indicator</u>	When the Lower Limit is On, a dotted blue line appears across the meter window at the point on the scale where the limit is set.
11. <u>"U-Lim" Soft Function Key F2</u>	Activates Upper Limit and selects Upper Limit value. Range is 0.0% to 100.0%. Upper Limit is turned Off from the Modulation Meter Menu.
12. <u>"Range" Soft Function Key F1</u>	Selects Modulation Meter Range. Select Autorange, 40% or 100%.
13. <u>Modulation Meter Digital Readout</u>	Provides a digital readout of the Modulation Percentage.
14. <u>PH</u>	Appears at the lower left side of the Meter window if PEAK HOLD is On.
15. <u>Meter Indicator Bar</u>	Displays Modulation Meter reading. Bar turns red when an Upper or Lower Limit is exceeded. Bar turns green if the current range is surpassed.
16. <u>Peak Hold Indicator</u>	Appears when PEAK HOLD is On. Indicator line shows the highest point of meter deflection.

ITEM	DESCRIPTION
17. <u>Upper Limit Indicator</u>	When Upper Limit is On, a dotted blue line appears across the meter window at the point on the scale where the limit is set.
18. <u>AR</u>	Appears at the upper right side of the meter window if the RANGE is set for Autorange. The Meter Range Scale changes to the next higher scale when the Meter Indicator Bar reaches the edge of the meter window. The meter changes to the next lower scale if the Meter Indicator Bar falls to a level of about 1/2 of the lowest scale division.
19. <u>Meter Range Scale</u>	The meter scale of four divisions is marked from 0 to the limits of the active scale with the center division labeled with the midpoint of the range.

With the Modulation Meter Operation Screen displayed, press the SETUP Key to access the Modulation Meter Menu.

MENU ITEM

DESCRIPTION

Modulation Meter Menu	
1. Meter Range	Autorange
2. Select Peak Hold	On
3. Upper Lmt	On
4. Set Upper Lmt	35.0 %
5. Lower Lmt	On
6. Set Lower Lmt	2.5 %
7. Set Alarm	Off

8610006

1. Meter Range

Selects Range. Select Autorange, 40% or 100%.

2. Select Peak Hold

Toggles Peak Hold On or Off.

3. Upper Lmt

Toggles Upper Limit On or Off.

4. Set Upper Limit

Selects Upper Limit Level. Range is from 0.0% to 100.0%.

5. Lower Lmt

Toggles Lower Limit On or Off.

6. Set Lower Limit

Selects Lower Limit Level. Range is from 0.0% to 100.0%.

7. Set Alarm

Toggles Alarm On or Off. Enabled Alarm sounds when Upper or Lower Limit is exceeded.



F. DISTORTION METER

With the Meter Menu displayed, press 6 DATA ENTRY Key to access the Distortion Meter Operation Screen:

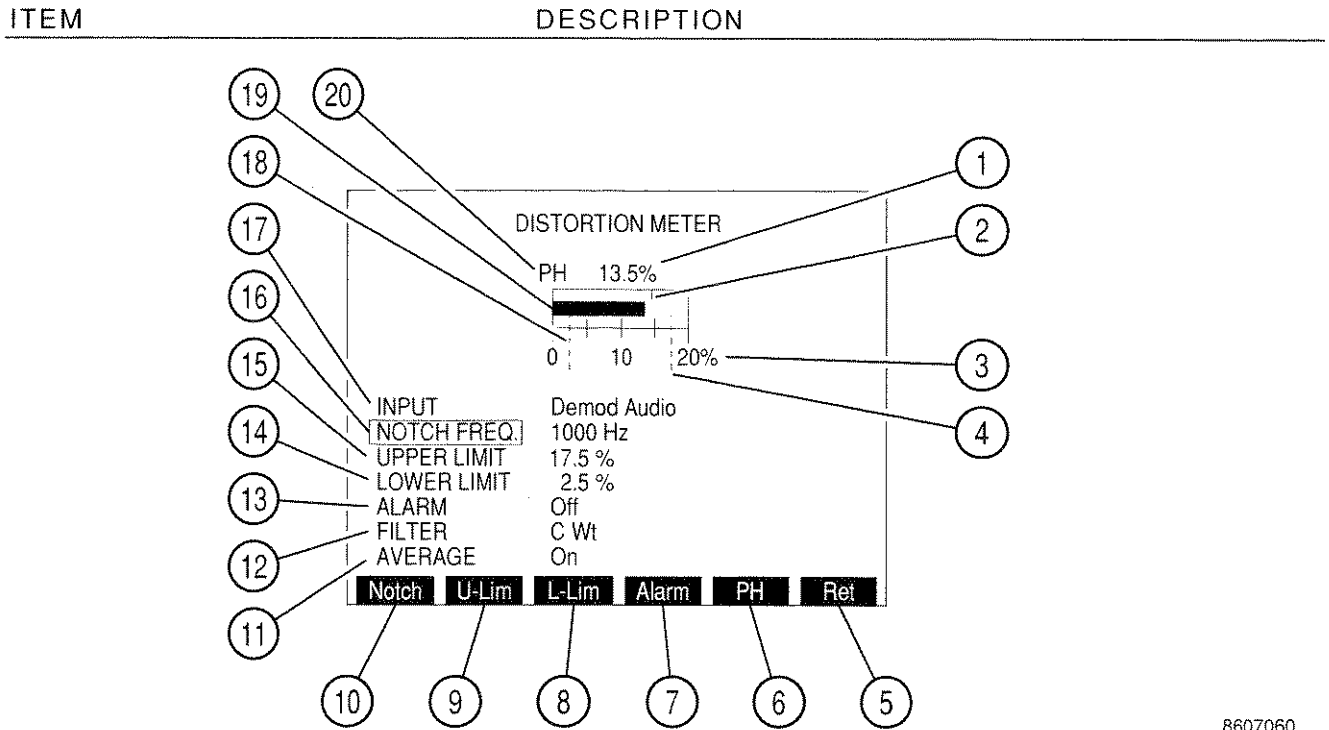

8607060

1. Digital Readout

Provides a digital readout of meter indication.

2. Peak Hold Indicator

Appears when Peak Hold is On. Indicator line shows the highest point of meter deflection.

3. Meter Range Scale

The meter scale of four divisions is marked from 0 to the limits of the active scale with the center division labeled with the midpoint of the range.

4. Upper Limit Indicator

When the Upper Limit is On, a dotted blue line appears across the meter window at the point on the scale where the limit is set. The indicator appears at the right edge of the meter window if the limit is set higher than the meter range.

ITEM	DESCRIPTION
5. <u>"Ret"/"ESC" Soft Function Key F6</u>	When editing a parameter, "ESC" is shown. Stops editing process and voids any changes to parameter. "Ret" returns operation to the screen from which meter was called.
6. <u>"PH" Soft Function Key F5</u>	Toggles Peak Hold On or Off.
7. <u>"Alarm" Soft Function Key F4</u>	Toggles Alarm On or Off. Enabled Alarm sounds when Upper or Lower Limit is exceeded.
8. <u>"L-Lim" Soft Function Key F3</u>	Activates Lower Limit and selects Lower Limit value. Range is 0.0% to 20.0%. Lower Limit is turned Off from Distortion Meter Menu.
9. <u>"U-Lim" Soft Function Key F2</u>	Activates Upper Limit and selects Upper Limit value. Range is 0.0% to 20.0%. Upper Limit is turned Off from the Distortion Meter Menu.
10. <u>"Notch" Soft Function Key F1</u>	Selects Notch Filter Frequency. Range is 600 to 1400 Hz.
11. <u>AVERAGE</u>	Toggles Average feature On or Off. When On, Meter reads a running average of last 10 readings.
12. <u>FILTER</u>	Selects Distortion Meter Filter. Select C Wt or Low-Pass. If Low-Pass is selected, a data field appears allowing entry of cutoff frequency. Range of the cutoff frequency is 0.1 to 30.0 kHz.
13. <u>ALARM</u>	Toggles Alarm On or Off. Enable Alarm sounds when Upper or Lower Limit is exceeded.
14. <u>LOWER LIMIT</u>	Activates Lower Limit and selects Lower Limit value. Range is 0.0% to 20.0%. Lower Limit is turned Off from Distortion Meter Menu.

ITEM	DESCRIPTION
15. <u>UPPER LIMIT</u>	Activates Upper Limit and selects Upper Limit value. Range is 0.0% to 20.0%. Upper Limit is turned Off from the Distortion Meter Menu.
16. <u>NOTCH FREQ</u>	Selects Notch Filter Frequency. Range is 600 to 1400 Hz.
17. <u>INPUT</u>	Selects Distortion Meter Input. Select Ext Mod (EXT MOD IN Connector), Demod Audio, Func Gen or SINAD/BER (SINAD/BER IN Connector).
18. <u>Lower Limit Indicator</u>	When the Lower Limit is On, a dotted blue line appears across the meter window at the point on the scale where the limit is set.
19. <u>Meter Indicator Bar</u>	Displays Distortion Meter reading. Bar turns red when an Upper or Lower Limit is exceeded. Bar turns green if the current range is surpassed.
20. <u>PH</u>	Appears above the left corner of the meter window if PEAK HOLD is On.

With the Distortion Meter Operation Screen displayed, press the SETUP Key to access the Distortion Meter Menu:

MENU ITEM

DESCRIPTION

Distortion Meter Menu	
1. Select Dist In	Demod Audio
2. Set Filter Freq	770 Hz
3. Select Peak Hold	On
4. Upper Lmt	On
5. Set Upper Lmt	17.5 %
6. Lower Lmt	On
7. Set Lower Lmt	2.5 %
8. Set Alarm	Off
9. Average	On
10. Filter Select	C wt

8610007

1. Select Dist In

Selects Distortion Meter Input. Select Demod Audio, SINAD/BER (SINAD/BER IN Connector), Func Gen or Ext Mod (EXT MOD IN Connector).

2. Set Filter Freq

Selects Notch Filter Frequency. Range is 600 to 1400 Hz.

3. Select Peak Hold

Toggles Peak Hold On or Off.

4. Upper Lmt

Toggles Upper Limit On or Off.

5. Set Upper Lmt

Selects Upper Limit Level. Range is 0.0% to 20.0%.

6. Lower Lmt

Toggles Lower Limit On or Off.

7. Set Lower Lmt

Selects Lower Limit Level. Range is 0.0% to 20.0%.

8. Set Alarm

Toggles Alarm On or Off. Enabled Alarm sounds when Upper or Lower Limit is exceeded.

MENU ITEM	DESCRIPTION
9. <u>Average</u>	Toggles Average feature On or Off. When On, Meter reads a running average of last 10 readings.
10. <u>Filter Select</u>	Selects Distortion Meter Filter. Select C Wt or Low-Pass. If Low-Pass is selected, a data field appears allowing entry of cutoff frequency. Range of cutoff frequencies is 0.1 to 30.0 kHz.

## G. SINAD METER

With the Meter Menu displayed, press 7 DATA ENTRY Key to access the SINAD Meter Operation Screen:

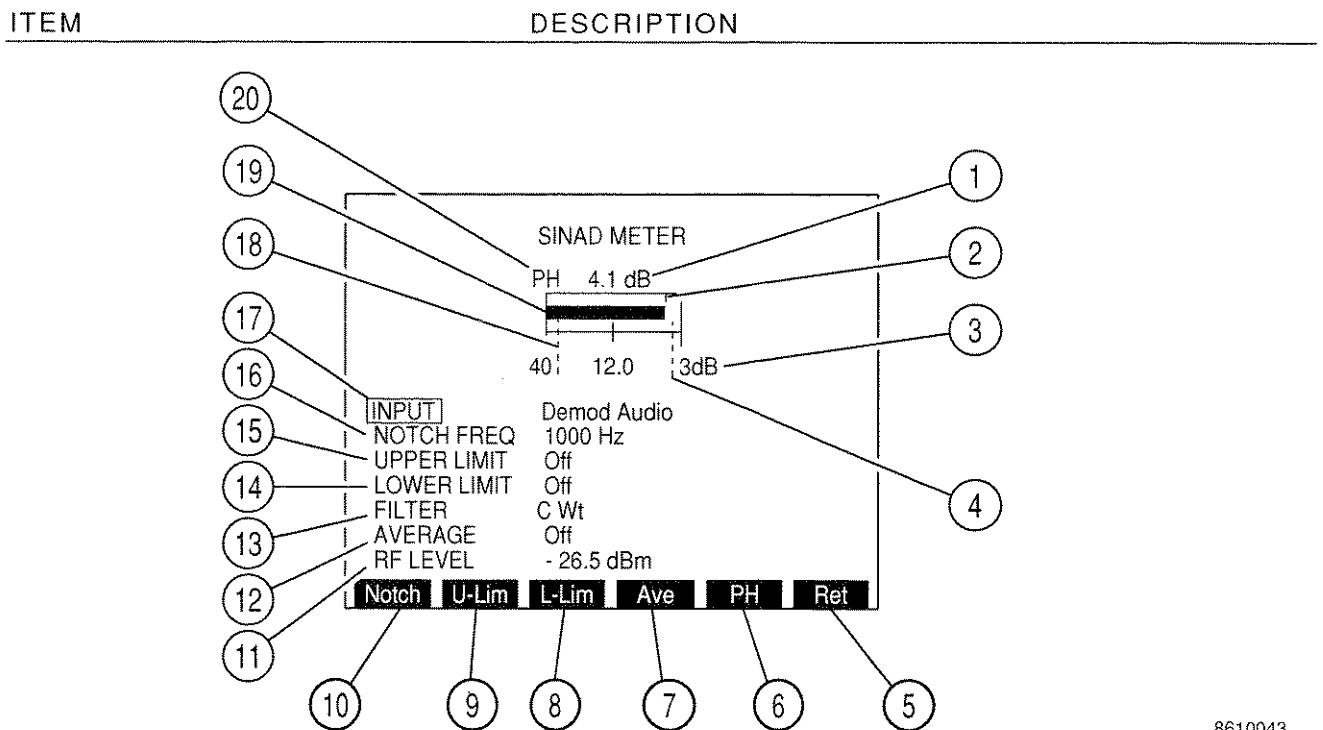

8610043

### 1. Digital Readout

Provides a digital readout of meter indication.

### 2. Peak Hold Indicator

Appears when Peak Hold is On. Indicator line shows the highest point of meter deflection.

### 3. Meter Range Scale

The meter scale of two divisions is marked from 3 to 40 dB with the center division labeled 12.0 dB.

### 4. Upper Limit Indicator

When the Upper Limit is On, a dotted blue line appears across the meter window at the point on the scale where the limit is set. The indicator appears at the right edge of the meter window if the limit is set higher than the meter range.

ITEM	DESCRIPTION
5. <u>"Ret"/"ESC" Soft Function Key F6</u>	When editing a parameter, "ESC" is shown. Stops editing process and voids any changes to parameter. "Ret" returns operation to the screen from which meter was called.
6. <u>"PH" Soft Function Key F5</u>	Toggles Peak Hold On or Off.
7. <u>"Ave" Soft Function Key F4</u>	Toggles Average feature On or Off. When On, Meter reads a running average of last 10 readings.
8. <u>"L-Lim" Soft Function Key F3</u>	Activates Lower Limit and selects Lower Limit value. Range is 3.0 to 40.0 dB. Lower Limit is turned Off from SINAD Meter Menu.
9. <u>"U-Lim" Soft Function Key F2</u>	Activates Upper Limit and selects Upper Limit value. Range is 3.0 to 40.0 dB. Upper Limit is turned Off from the SINAD Meter Menu.
10. <u>"Notch" Soft Function Key F1</u>	Selects Notch Filter Frequency. Range is 600 to 1400 Hz.
11. <u>RF LEVEL</u>	Appears if RF GEN, Duplex or Duplex Receiver is the last accessed Operation Screen. Displays RF Generator or Duplex Receiver Output Level.
12. <u>AVERAGE</u>	Toggles Average feature On or Off. When On, Meter reads a running average of last 10 readings.
13. <u>FILTER</u>	Selects SINAD Filter. Select C Wt or Low-Pass. If Low-Pass is selected, a data field appears allowing entry of cutoff frequency. Range of cutoff frequencies is 0.1 to 30.0 kHz.
14. <u>LOWER LIMIT</u>	Activates Lower Limit and selects Lower Limit value. Range is 3.0 to 40.0 dB. Lower Limit is turned Off from SINAD Meter Menu.

ITEM	DESCRIPTION
15. <u>UPPER LIMIT</u>	Activates Upper Limit and selects Upper Limit value. Range is 3.0 to 40.0 dB. Upper Limit is turned Off from the SINAD Meter Menu.
16. <u>NOTCH FREQ</u>	Selects Notch Filter Frequency. Range is 600 to 1400 Hz.
17. <u>INPUT</u>	Selects SINAD Meter Input. Select Demod Audio, SINAD/BER, Func Gen or Ext Mod.
18. <u>Lower Limit Indicator</u>	When the Lower Limit is On, a dotted blue line appears across the meter window at the point on the scale where the limit is set.
19. <u>Meter Indicator Bar</u>	Displays SINAD Meter reading. Bar turns red when an Upper or Lower Limit is exceeded. Bar turns green if the current range is surpassed.
20. <u>PH</u>	Appears above the left corner of the meter window if PEAK HOLD is On.



With the SINAD Meter Operation Screen displayed, press the SETUP Key to access the SINAD Meter Menu:

MENU ITEM

DESCRIPTION

SINAD Meter Menu	
1. Select SINAD In	Demod Audio
2. Notch Filter Freq	1000 Hz
3. Select Peak Hold	Off
4. Upper Lmt	Off
5. Set Upper Lmt	3.0 dB
6. Lower Lmt	Off
7. Set Lower Lmt	30.0 dB
8. Average	Off
9. Filter Select	C Wt
10. Readout Res.	.5 dB

8610008

1. Select SINAD In

Selects SINAD Meter Input. Select Demod Mod, SINAD/BER, Func Gen or Ext Audio.

2. Notch Filter Freq

Selects Notch Filter Frequency. Range is 600 to 1400 Hz.

3. Select Peak Hold

Toggles Peak Hold On or Off.

4. Upper Lmt

Toggles Upper Limit On or Off.

5. Set Upper Lmt

Selects Upper Limit Level. Range is 3.0 to 40.0 dB.

6. Lower Lmt

Toggles Lower Limit On or Off.

7. Set Lower Lmt

Selects Lower Limit Level. Range is 3.0 to 40.0 dB.

8. Average

Toggles Average feature On or Off. When On, Meter reads a running average of last 10 readings.

MENU ITEM

DESCRIPTION

---

9. Filter Select

Selects SINAD Filter. Select C Wt or Low-Pass. If Low-Pass is selected, a data field appears allowing entry of cutoff frequency. Range of cutoff frequencies is 0.1 to 30.0 kHz.

10. Readout Res.

Selects resolution of Digital Readout. Toggles between .1 dB and .5 dB.

## H. SIGNAL STRENGTH METER

With the Meter Menu displayed, press 8 DATA ENTRY Key to access the Signal Strength Meter Operation Screen:

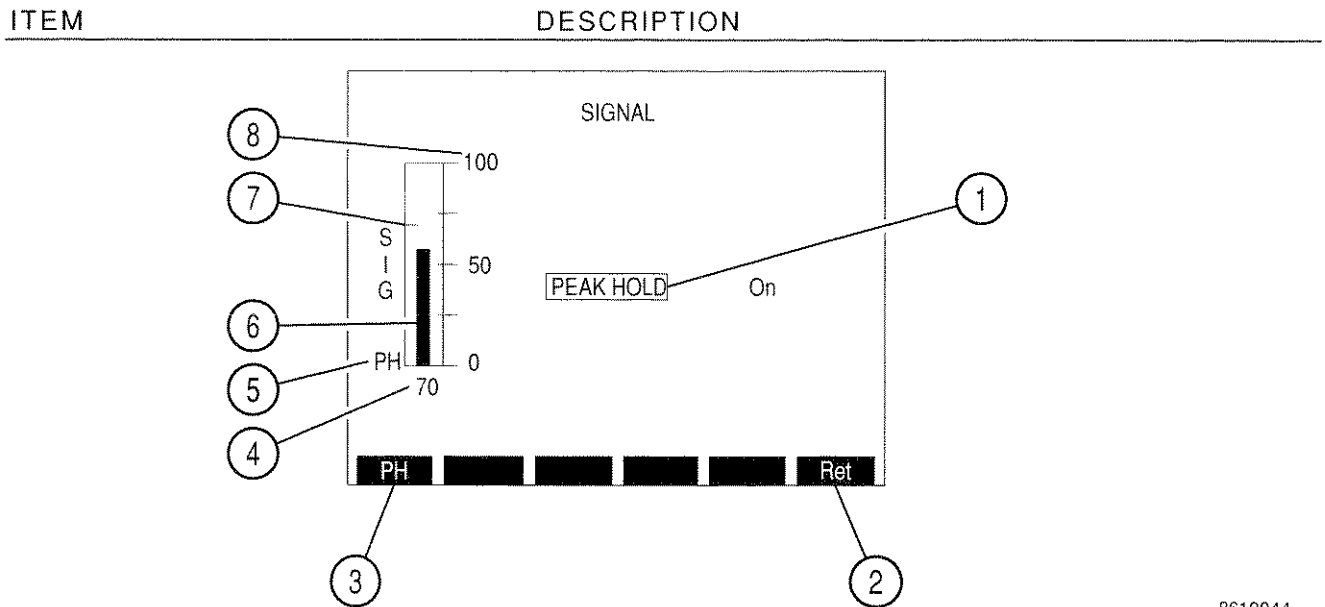

8610044

1. PEAK HOLD

Toggles Peak Hold On or Off.

2. "Ret" Soft Function Key F6

"Ret" returns operation to the screen from which meter was called.

3. "PH" Soft Function Key F1

Toggles Peak Hold On or Off.

4. Signal Strength Digital Readout

Provides digital Signal Strength Meter readings.

5. PH

When PEAK HOLD is On, this indicator appears beside the lower left corner of the meter window.

6. Meter Indicator Bar

Displays Signal Strength Meter readings.

ITEM	DESCRIPTION
------	-------------

7. Peak Hold Indicator

Appears when PEAK HOLD is On. Indicator line shows the highest point of meter deflection.

8. Meter Range Scale

The meter scale of four divisions is marked from 0 to 100 with the center division marked 50.

With the Signal Strength Meter Operation Screen displayed, press the SETUP Key to access the Signal Strength Meter Menu:

MENU ITEM	DESCRIPTION
-----------	-------------

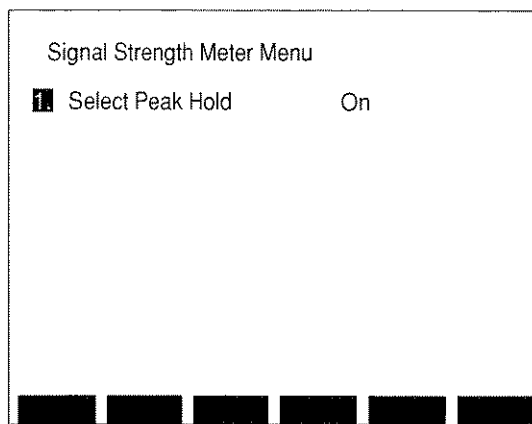

8610009

1. Select Peak Hold

Toggles Peak Hold On or Off.

## I. BIT ERROR RATE (BER) METER

With the Meter Menu displayed, press 9 DATA ENTRY Key to access the BER Meter Operation Screen.

ITEM	DESCRIPTION
------	-------------

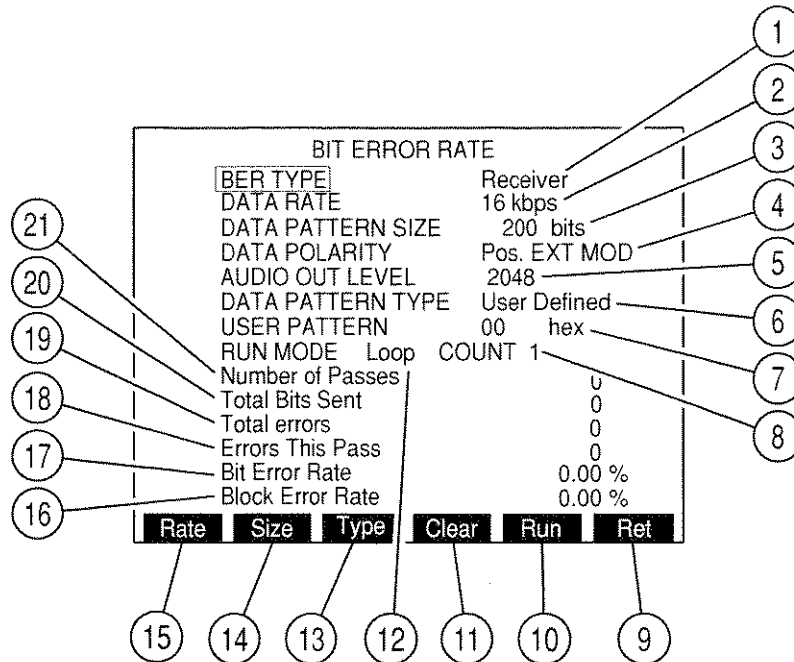

8610030

### 1. BER TYPE

Selects BER Type. Select Receiver, Generator, Baseband or Duplex.

- With Receiver BER Type, the specified test data is sent through the AUDIO OUT Connector which the UUT uses to modulate its signal. The UUT Output returns to the specified connector of the Test Set and is demodulated and compared to the original test data.
- With Generator BER Type, the modulated test data is sent to the UUT to be demodulated. The demodulated data is received by the Test Set and compared with the original test data.
- With Baseband BER Type, the test data is sent through the AUDIO OUT Connector to be modulated and then demodulated by the UUT. Demodulated UUT output is received by the Test Set and compared to the original test data.
- With Duplex BER Type, the modulated test data is sent to the UUT to be demodulated and then modulated. This signal is received and demodulated by the Test Set and compared to the original test data.

ITEM	DESCRIPTION									
2. <u>DATA RATE</u>	Selects baud rate of data. Select one of the following:									
	<table> <tr> <td>75 bps</td> <td>150 bps</td> <td>300 bps</td> </tr> <tr> <td>600 bps</td> <td>1200 bps</td> <td>2400 bps</td> </tr> <tr> <td>4800 bps</td> <td>16 kbps</td> <td></td> </tr> </table>	75 bps	150 bps	300 bps	600 bps	1200 bps	2400 bps	4800 bps	16 kbps	
75 bps	150 bps	300 bps								
600 bps	1200 bps	2400 bps								
4800 bps	16 kbps									
3. <u>DATA PATTERN SIZE</u>	Selects number of bits for each pass. Range is from 100 to 100000 bits.									
4. <u>DATA POLARITY</u>	Select Positive received at EXT MOD IN Connector or Negative (inverted) received at SINAD/BER IN Connector.									
5. <u>AUDIO OUT LEVEL/RF GEN LEVEL</u>	<ul style="list-style-type: none"> <li>● AUDIO OUT LEVEL is displayed for Receiver and Baseband BER Types. Select from 0 to 4095 bits. 0 corresponds to 0 V, and 4095 corresponds to 5 V.</li> <li>● RF GEN LEVEL is displayed for Generator and Duplex BER Types. Range is from -137.0 to 0.0 dBm or 0.031 <math>\mu</math>V to 0.224 V.</li> </ul>									
6. <u>DATA PATTERN TYPE</u>	Select Random, Fixed or User Defined.									
7. <u>USER PATTERN</u>	Appears when "User Defined" is selected as DATA PATTERN TYPE. Enter User Pattern in hexadecimal digits using DATA ENTRY Keypad.									
8. <u>Loop COUNT</u>	Appears when Loop is selected as RUN MODE. Select loop count from 1 to 100000.									
9. <u>"Ret"/"ESC" Soft Function Key F6</u>	When editing a parameter, "ESC" is shown. Stops editing process and voids any changes to parameter. "Ret" returns operation to the screen from which meter was called.									
10. <u>"Run"/"Stop" Soft Function Key F5</u>	Pressing "Run" Starts BER test and changes Soft Function Key to "Stop." Pressing "Stop" stops BER test.									
11. <u>"Clear" Soft Function Key F4</u>	Clears BER test readout data.									

ITEM	DESCRIPTION									
12. <u>RUN MODE</u>	<p>Selects BER Meter Run Mode. Select from Continuous, One Shot or Loop.</p> <ul style="list-style-type: none"> <li>● With Continuous Run Mode, the BER tests are run until "Stop" Soft Function Key F5 is pressed.</li> <li>● With One Shot Run Mode, one pass is completed. The size of the pass is set by DATA PATTERN SIZE.</li> <li>● With Loop Run Mode, the specified number of passes is completed unless "Stop" Soft Function Key F5 is pressed. The number of passes completed is set by the Loop COUNT.</li> </ul>									
13. <u>"Type" Soft Function Key F3</u>	<p>Selects DATA PATTERN TYPE. Select Random, Fixed or User Defined.</p>									
14. <u>"Size" Soft Function Key F2</u>	<p>Selects DATA PATTERN SIZE (number of bits for each pass). Range is from 100 to 100000 bits.</p>									
15. <u>"Rate" Soft Function Key F1</u>	<p>Selects baud rate of data. Select one of the following:</p> <table border="0" data-bbox="402 993 1185 1087"> <tr> <td>75 bps</td> <td>150 bps</td> <td>300 bps</td> </tr> <tr> <td>600 bps</td> <td>1200 bps</td> <td>2400 bps</td> </tr> <tr> <td>4800 bps</td> <td>16 kbps</td> <td></td> </tr> </table>	75 bps	150 bps	300 bps	600 bps	1200 bps	2400 bps	4800 bps	16 kbps	
75 bps	150 bps	300 bps								
600 bps	1200 bps	2400 bps								
4800 bps	16 kbps									
16. <u>Block Error Rate</u>	<p>Percentage readout of the ratio of blocks with at least one error versus the number of blocks sent during the BER test.</p>									
17. <u>Bit Error Rate</u>	<p>Percentage readout of the ratio of bit errors versus the number or bits sent during the BER test.</p>									
18. <u>Errors This Pass</u>	<p>Readout of the number of errors detected during current pass. The number of bits specified by the DATA PATTERN SIZE is processed during each pass.</p>									
19. <u>Total Errors</u>	<p>Readout of the total number of errors occurring during the BER test.</p>									
20. <u>Total Bits Sent</u>	<p>Readout of the total number of bits sent during the BER test.</p>									

ITEM

DESCRIPTION

---

21. Number of Passes

Readout of the number of passes made during the BER test.



With the BER Meter Operation Screen displayed, press the SETUP Key to access the BER Meter Menu. There are 4 different BER METER MENU Screens, one for each BER Type. If "Receiver" is the BER Type, the following screen is displayed:

MENU ITEM	DESCRIPTION
-----------	-------------

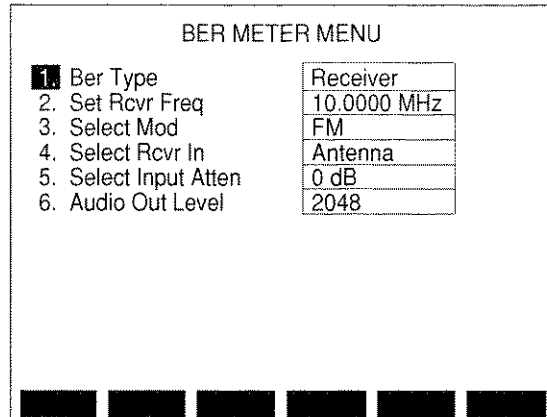

8610094

1. BER Type

Selects BER Type. Select Receiver, Generator, Baseband or Duplex. Changing BER Type changes BER METER MENU.

2. Set Rcvr Freq

Selects Receiver Frequency. Range is from 0.2500 to 2010.0000 MHz.

3. Select Mod

Displays Modulation Submenu:

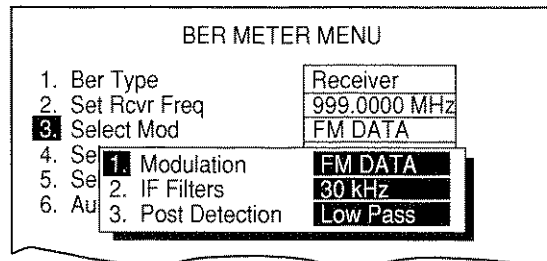

8610095

- Selects Received Modulation. Select FM, AM, BFO, PM or FM DATA.
- Selects Receiver IF Filter. Select from 10, 30 or 300 kHz.

MENU ITEM

DESCRIPTION

- Select Receiver Post Detection Filter. Select All Pass, Low-Pass, High-Pass or Bandpass. If Low-Pass, High-Pass or Bandpass is selected, a data field is displayed to allow entry of cutoff frequencies. Range of the cutoff frequencies are:

All-Pass	N/A
Low-Pass	0.100 to 30.000 kHz.
High-Pass	0.500 to 20.000 kHz.
Bandpass low	0.500 to 20.000 kHz.
Bandpass high	0.100 to 30.000 kHz.

4. Select Rcvr In

Toggles Receiver Input between ANTENNA IN and T/R Connector.

5. Select Input Atten

Selects Input Attenuation. Select 0, 20 or 40 dB.

6. Audio Out Level

Selects Test Data Output Level at AUDIO OUT Connector. Select from 0 to 4095. 0 corresponds to 0 V, and 4095 corresponds to 5 V.

If "Generator" is the BER Type, the Generator BER Meter Menu is displayed:

MENU ITEM	DESCRIPTION
-----------	-------------

BER METER MENU	
1. Ber Type	Generator
2. RF Gen Freq	10.0000 MHz
3. RF Gen Level	- 20.0 dBm
4. RF Gen Level Units	dBm
5. RF Gen Mod	FM
6. RF Gen Mod Level	255

8610097

1. BER Type

Selects BER Type. Select Receiver, Generator, Baseband or Duplex. Changing BER Type changes BER Meter Menu. With Generator BER Type, the modulated test data is sent to the UUT to be demodulated. The demodulated data is received by the Test Set and compared with the original test data.

2. RF Gen Freq

Selects RF Generator Frequency. Range is from 0.2500 to 2010.0000 MHz.

3. RF Gen Level

Selects RF Generator Output Level. Range is from -137.0 to 0.0 dBm or 0.031  $\mu$ V to 0.224 V.

4. RF Gen Level Units

Selects RF Generator Output Level Units. Toggles between dBm and Volts. Also changes RF Generator Output Level Units and Spectrum Analyzer Tracking Generator Output Level Units to units selected.

5. RF Gen Mod

Selects RF Generator Modulation. Select AM, FM or OFF.

6. RF Gen Mod Level

Selects RF Generator Modulation Level. Range is from 0.0 to 25.0 kHz for FM modulation. Range is from 0% to 90% for AM modulation.

If "Baseband" is the BER Type, the Baseband BER Meter Menu is displayed:

MENU ITEM

DESCRIPTION

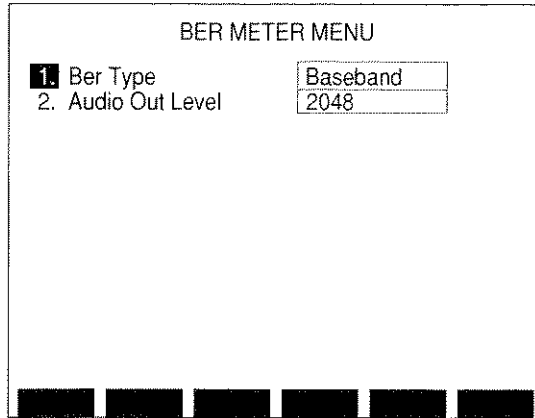

8610096

1. BER Type

Selects BER Type. Select Receiver, Generator, Baseband or Duplex. Changing BER Type changes BER Meter Menu.

2. Audio Out Level

Selects Test Data Output Level at AUDIO OUT Connector. Select from 0 to 4095. 0 corresponds to 0 V, and 4095 corresponds to 5 V.

If "Duplex" is the BER Type, the Duplex BER Meter Menu is displayed:

MENU ITEM DESCRIPTION

BER METER MENU	
1. Ber Type	Duplex
2. Set Rcvr Freq	10.0000 MHz
3. Select Mod	FM
4. Select Rcvr In	Antenna
5. Select Input Atten	0 dB
6. RF Gen Freq	10.0000 MHz
7. RF Gen Level	-20.1 dBm
8. RF Gen Level Units	dBm
9. RF Gen Mod	Off
10. RF Gen Mod Level	128
11. RF Gen Output	T/R

8610098

1. BER Type

Selects BER Type. Select Receiver, Generator, Baseband or Duplex. Changing BER Type changes BER Meter Menu. With Duplex BER Type, the modulated test data is sent to the UUT to be demodulated and then modulated. This signal is received and demodulated by the Test Set and compared to the original test data.

2. Set Rcvr Freq

Selects Receiver Frequency. Range is from 0.2500 to 2010.0000 MHz.

3. Select Mod

Displays Modulation Submenu:

BER METER MENU	
1. Ber Type	Duplex
2. Set Rcvr Freq	999.0000 MHz
3. Select Mod	FM DATA
4. Set	1. Modulation FM DATA
5. Set	2. IF Filters 30 kHz
6. Au	3. Post Detection Low Pass

8610172

- Selects Received Modulation. Select FM, AM, BFO, PM or FM DATA.
- Selects Receiver IF Filter. Select from 10, 30 or 300 kHz.

MENU ITEM

DESCRIPTION

- Select Receiver Post Detection Filter. Select All Pass, Low-Pass, High-Pass or Bandpass. If Low-Pass, High-Pass or Bandpass is selected, a data field is displayed to allow entry of cutoff frequencies. Range of the cutoff frequencies are:

All-Pass	N/A
Low-Pass	0.100 to 30.000 kHz.
High-Pass	0.500 to 20.000 kHz.
Bandpass low	0.500 to 20.000 kHz.
Bandpass high	0.100 to 30.000 kHz.

4. Select Rcvr In

Selects Receiver Input Connector. Toggles between ANTENNA IN or T/R Connector.

5. Select Input Atten

Selects Input Attenuation. Select 0, 20 or 40 dB.

6. RF Gen Freq

Selects RF Generator Frequency. Range is from 0.2500 to 2010.0000 MHz.

7. RF Gen Level

Selects RF Generator Output Level. Range is from -137.0 to 0.0 dBm or 0.031  $\mu$ V to 0.224 V for Duplex RF Gen Output. Range is from -120.0 to 10.0 dBm or 0.224  $\mu$ V to 0.707 V for T/R RF Gen Output.

8. RF Gen Level Units

Selects RF Generator Output Level Units. Toggles between dBm and Volts.

9. RF Gen Mod

Selects RF Generator Modulation Type. Select AM, FM or OFF.

10. RF Gen Mod Level

Selects RF Generator Modulation Level. Range is from 0.0 to 25.0 kHz for FM modulation. Range is from 0% to 90% for AM modulation.

11. RF Gen Output

Selects RF Generator Output Connector. Toggles between "T/R" and "Duplex."

## J. DIGITAL MULTIMETER

With the Meter Menu displayed, use the FIELD SELECT Keys to highlight "10. Digital Multimeter (DMM)" and press the ENTER Key to access the Digital Multimeter Operation Screen.

**NOTE:** The Digital Multimeter appears in the Function last used.

The "Install Shunt Between V $\Omega$  and COM" message appears when 20 A range is accessed.

ITEM	DESCRIPTION
------	-------------

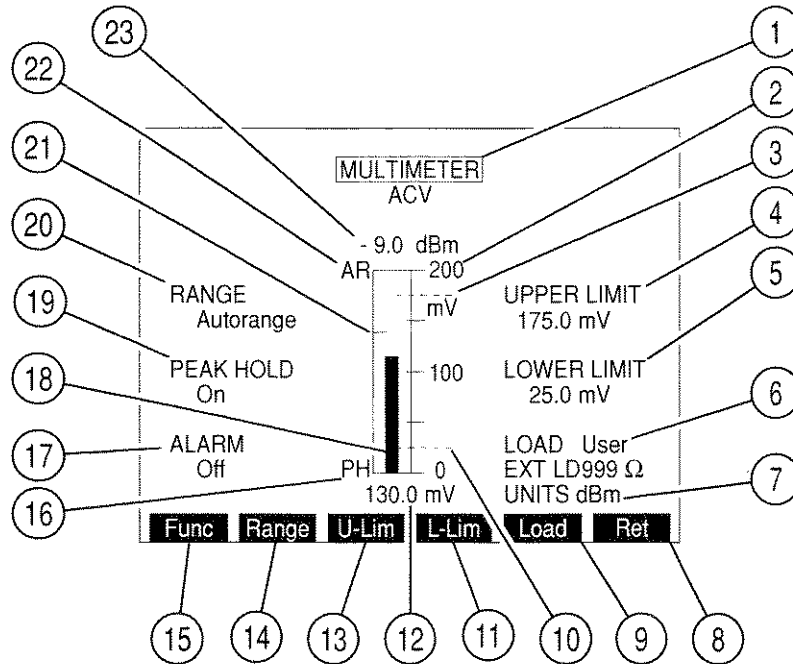

03416040

### 1. MULTIMETER

Selects Multimeter Function. Select ACV, DCV, ACC, DCC or Ohm.

SELECTION	FUNCTION
ACV	Voltage ac
DCV	Voltage dc
ACC	Current ac
DCC	Current dc
Ohm	Resistance in ohms

### 2. Meter Range Scale

The meter scale of four divisions is marked from 0 to the limits of the active range scale with the center division labeled with the midpoint of the range.

ITEM	DESCRIPTION
3. <u>Upper Limit Indicator</u>	When Upper Limit is On, a dotted blue line appears across the meter window at the point on the scale where the limit is set. The indicator appears at the window's upper edge if the limit is set higher than the meter range.
4. <u>UPPER LIMIT</u>	Activates Upper Limit and selects Upper Limit value. If ACV or DCV is selected as the Function, Range is from 0.0 mV to 1000.00 V. If ACC or DCC is selected as the Function, range is from 0.00 mA to 19.990 A. If Ohm is selected as the Function, range is from 0.000 $\Omega$ to 19.990 M $\Omega$ . Upper Limit is turned Off from the Multimeter Menu. Upper Limit must be less than the highest value of the current range to operate correctly.
5. <u>LOWER LIMIT</u>	Activates Lower Limit and selects Lower Limit value. If ACV or DCV is selected as the Function, Range is from 0.0 mV to 1000.00 V. If ACC or DCC is selected as the Function, range is from 0.00 mA to 19.990 A. If Ohm is selected as the Function, range is from 0.000 $\Omega$ to 19.990 M $\Omega$ . Lower Limit is turned Off from the Multimeter Menu. Lower Limit must be less than the highest value of the current range to operate correctly.
6. <u>LOAD</u>	Appears when "ACV" is selected as MULTIMETER Function. Select 1 MEG, 600 $\Omega$ , 150 $\Omega$ or User. User allows the use of an external load from 1 to 999 $\Omega$ . If User is selected, a callout is displayed for external load entry used to ensure dBm Callout accuracy. The external load is installed by the operator.
7. <u>UNITS</u>	"UNITS" appears when 600 $\Omega$ , 150 or User LOAD (see operation screen Item "LOAD") is selected. If UNITS is selected, the callout may be toggled to either "dBm or "Watts" by pressing ENTER Key. The selection determines the units the dBm/W Digital Reading displays (see operation screen Item "dBm/W Digital Reading").
8. <u>"Ret"/"ESC" Soft Function Key F6</u>	When editing a parameter, "ESC" is shown. Stops editing process and voids any changes to parameters. "Ret" returns operation to the screen from which meter was called.
9. <u>"Load" Soft Function Key F5</u>	Appears when "ACV" is selected as MULTIMETER Function. Select 1 MEG, 600 $\Omega$ , 150 $\Omega$ or User. User allows the use of an external load from 1 to 999 $\Omega$ . If User is selected, a callout is displayed for external load entry used to ensure dBm callout accuracy. The external load is installed by the operator.



ITEM	DESCRIPTION
10. <u>Lower Limit Indicator</u>	When the Lower Limit is On, a dotted blue line appears across the meter window at the point on the scale where the limit is set.
11. <u>"L-Lim" Soft Function Key F4</u>	Activates Lower Limit and selects Lower Limit value. If ACV or DCV is selected as the Function, range is from 0.0 mV to 1000.00 V. If ACC or DCC is selected as the Function, range is from 0.00 mA to 19.990 A. If Ohm is selected as the Function, range is from 0.000 $\Omega$ to 19.990 M $\Omega$ . Lower Limit is turned Off from the Multimeter Menu. Lower Limit must be less than the highest value of the current range to operate correctly.
12. <u>Digital Meter Readout</u>	Digital readout of meter in the units set by the meter scale. If Peak Hold is On, the readout reads the highest meter deflection.
13. <u>"U-Lim" Soft Function Key F3</u>	Activates Upper Limit and selects Upper Limit value. If ACV or DCV is selected as the Function, Range is from 0.0 mV to 1000.00 V. If ACC or DCC is selected as the Function, range is from 0.00 mA to 19.990 A. If Ohm is selected as the Function, range is from 0.000 $\Omega$ to 19.990 M $\Omega$ . Upper Limit is turned Off from the Multimeter Menu. Upper Limit must be less than the highest value of the current range to operate correctly.
14. <u>"Range" Soft Function Key F2</u>	<p>Selects Meter Range.</p> <ul style="list-style-type: none"> <li>● For Functions ACV or DCV, select Autorange, 200 mV, 2.0 V, 20 V, 200 V or 2000 V.</li> <li>● For Functions ACC or DCC, select Autorange, 20 mA, 200 mA, 2 A or 20 A.</li> <li>● For Ohm Function, select Autorange, 200 <math>\Omega</math>, 2 k<math>\Omega</math>, 20 k<math>\Omega</math>, 200 k<math>\Omega</math>, 2 M<math>\Omega</math> or 20 M<math>\Omega</math>.</li> </ul>
15. <u>"Func" Soft Function Key F1</u>	Selects Multimeter Function. See operation screen Item "MULTIMETER."
16. <u>PH</u>	When PEAK HOLD is On, this indicator appears beside the lower left corner of the meter window.
17. <u>ALARM</u>	Toggles Alarm On or Off. Enables Alarm sounds when Upper or Lower Limit is exceeded.

ITEM	DESCRIPTION
18. <u>Meter Indicator Bar</u>	Displays Meter reading. Bar turns red when an Upper or Lower Limit is exceeded. Bar turns green if the current range is surpassed.
19. <u>PEAK HOLD</u>	Toggles Peak Hold On or Off.
20. <u>RANGE</u>	<p>Selects Meter Range.</p> <ul style="list-style-type: none"> <li>● For Functions ACV or DCV, select Autorange, 200 mV, 2.0 V, 20 V, 200 V or 2000 V.</li> <li>● For Functions ACC or DCC, select Autorange, 20 mA, 200 mA, 2 A or 20 A.</li> <li>● For Ohm Function, select Autorange, 200 <math>\Omega</math>, 2 k<math>\Omega</math>, 20 k<math>\Omega</math>, 200 k<math>\Omega</math>, 2 M<math>\Omega</math> or 20 M<math>\Omega</math>.</li> </ul>
21. <u>PEAK HOLD Indicator</u>	Appears when PEAK HOLD is On. Indicator line shows the highest point of meter deflection.
22. <u>AR</u>	Appears above the upper left corner of the meter window if the RANGE is set for Autorange. The Meter Range Scale changes to the next higher scale when the Meter Indicator Bar reaches the edge of the meter window. The meter changes to the next lower scale if the Meter Indicator Bar falls to a level of about 1/2 of the lowest scale division.
23. <u>dBm/W Digital Reading</u>	Appears if ACV is selected for Multimeter Function unless 1 MEG is selected for LOAD. Displays Meter reading in dBm or Watts as determined by the UNITS function.

With Digital Multimeter Operation Screen displayed, press SETUP Key to access the Multimeter Menu:

MENU ITEM DESCRIPTION

Multimeter Menu	
1. Multimeter Func	ACV
2. Set Range	Autorange
3. Select Peak Hold	On
4. Upper Lmt	On
5. Set Upper Lmt	175.0 mV
6. Lower Lmt	On
7. Set Lower Lmt	25.0 mV
8. Set Alarm	Off
9. dBm/Watts Enable	dBm

8610389

1. Multimeter Func

Selects Multimeter Function. Select ACV, DCV, ACC, DCC or Ohm.

SELECTION	FUNCTION
ACV	Voltage ac
DCV	Voltage dc
ACC	Current ac
DCC	Current dc
Ohm	Resistance in ohms

2. Set Range

Selects Meter Range.

- For Functions ACV or DCV, select Autorange, 200 mV, 2.0 V, 20 V, 200 V or 2000 V.
- For Functions ACC or DCC, select Autorange, 20 mA, 200 mA, 2 A or 20 A.
- For Ohm Function, select Autorange, 200  $\Omega$ , 2 k $\Omega$ , 20 k $\Omega$ , 200 k $\Omega$ , 2 M $\Omega$  or 20 M $\Omega$ .

3. Select Peak Hold

Toggles Peak Hold between On and Off.

4. Upper Lmt

Toggles Upper Limit between On and Off.

## MENU ITEM

## DESCRIPTION

5. Set Upper Lmt

Selects Upper Limit Level. If ACV or DCV is selected as the Function, range is from 0.0 mV to 1000.00 V. If ACC or DCC is selected as the Function, range is from 0.00 mA to 19.990 A. If Ohm is selected as the Function, range is from 0.000  $\Omega$  to 19.990 M $\Omega$ . Upper Limit must be less than the highest value of the current range to operate correctly.

6. Lower Lmt

Toggles Lower Limit between On and Off.

7. Set Lower Lmt

Selects Lower Limit. If ACV or DCV is selected as the Function, range is from 0.0 mV to 1000.00 V. If ACC or DCC is selected as the Function, range is from 0.00 mA to 19.990 A. If Ohm is selected as the Function, range is from 0.000  $\Omega$  to 19.990 M $\Omega$ . Upper Limit must be less than the highest value of the current range to operate correctly.

8. Set Alarm

Toggles Alarm On or Off. Enable Alarm sounds when Upper or Lower Limit is exceeded.

9. dBm/Watts Enable

Toggles units of power readout above meter between dBm and Watts. Applicable only when DMM is in ACV function mode and LOAD is set to any value other than 1 MEG.

## K. PHASE METER

With the Meter Menu displayed, use the FIELD SELECT Keys to highlight "11. Phase Meter" and press the ENTER Key to access the Phase Meter Operation Screen:

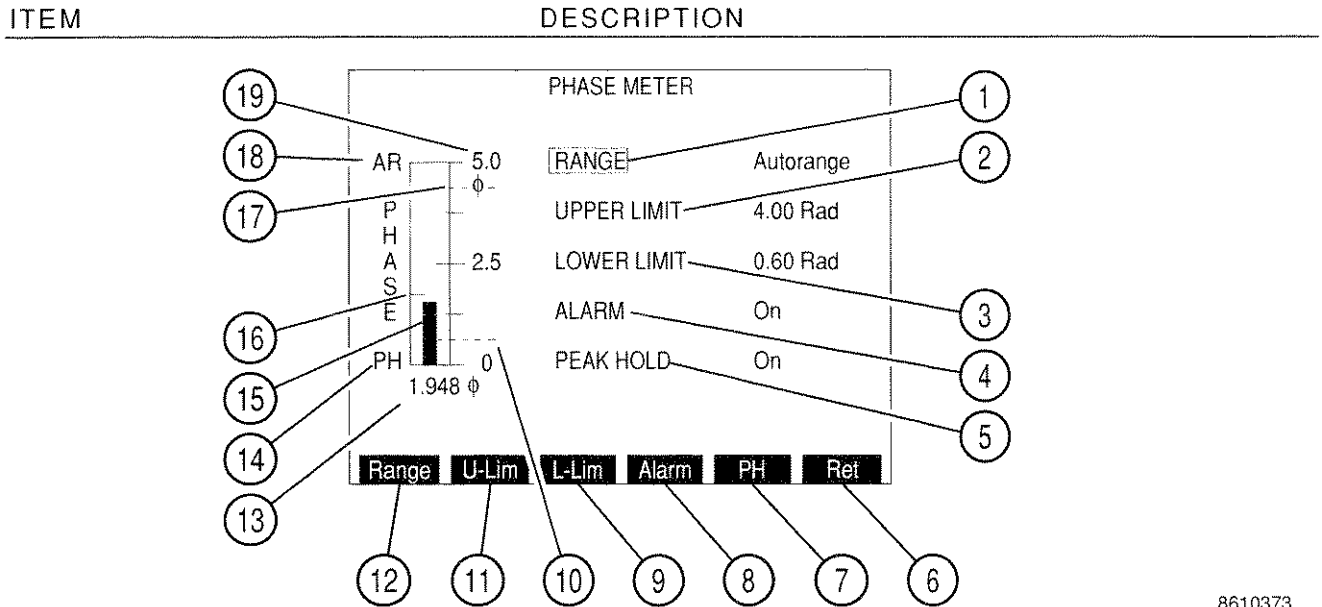

8610373

### 1. RANGE

Selects Meter Range. Select Aurorange, 1, 5 or 10 radians.

### 2. UPPER LIMIT

Activates Upper Limit and selects Upper Limit value. Range is from 0.00 to 10.00 radians. Upper Limit is turned Off from Phase Meter Menu.

### 3. LOWER LIMIT

Activates Lower Limit and selects Lower Limit value. Range is from 0.00 to 10.00 radians. Lower Limit is turned Off from Phase Meter Menu.

### 4. ALARM

Toggles Alarm between On and Off. Enabled Alarm sounds when an Upper or Lower Limit is exceeded.

### 5. PEAK HOLD

Toggles Peak Hold between On and Off.

### 6. "Ret"/"ESC" Soft Function Key F6

When editing a parameter, "ESC" is shown. Stops editing process and voids any changes to parameters. "Ret" returns operation to the screen from which meter was called.

ITEM	DESCRIPTION
7. <u>"PH" Soft Function Key F5</u>	Toggles Peak Hold between On and Off.
8. <u>"Alarm" Soft Function Key F4</u>	Toggles Alarm between On and Off. Enabled Alarm sounds when Upper or Lower Limit is exceeded.
9. <u>"L-Lim" Soft Function Key F3</u>	Activates Lower Limit and selects Lower Limit value. Range is from 0.00 to 10.00 radians. Lower Limit is turned Off from Phase Meter Menu.
10. <u>Lower Limit Indicator</u>	When Lower Limit feature is On, a dotted blue line appears across the meter window at the point on the scale where the limit is set.
11. <u>"U-Lim" Soft Function Key F2</u>	Activates Upper Limit and selects Upper Limit value. Range is from 0.00 to 10.00 radians. Upper Limit is turned Off from Phase Meter Menu.
12. <u>"Range" Soft Function Key F1</u>	Selects Meter Range. Select Autorange, 1, 5 or 10 radians.
13. <u>Digital Meter Readout</u>	Digital readout of meter in radians. If PEAK HOLD is On, the readout reads the highest meter deflection.
14. <u>PH</u>	Appears beside the meter window lower left corner if PEAK HOLD is On.
15. <u>Meter Indicator Bar</u>	Displays Meter reading. Bar turns red when an Upper or Lower Limit is exceeded. Bar turns green if the current range is surpassed.
16. <u>Peak Hold Indicator</u>	Appears when PEAK HOLD is On. Indicator line shows the highest point of meter deflection.

## ITEM

DESCRIPTION

---

17. Upper Limit Indicator

When Upper Limit feature is On, a dotted blue line appears across the meter window at the point on the scale where the limit is set. The indicator appears at the window's upper edge if the limit is set higher than the meter range.

18. AR

Indicator appears above the upper left corner of the meter window if the RANGE is set for Autorange. The Meter Range Scale changes to the next higher scale when the Meter Indicator Bar reaches the edge of the meter window. The meter changes to the next lower scale if the Meter Indicator Bar falls to a level of about 1/2 of the lowest scale division.

19. Meter Range Scale

The meter scale of four divisions is marked from 0 to the limits of the active range scale with the center division labeled with the midpoint of the range.

With the Phase Meter Operation Screen displayed, press the SETUP Key to access the Phase Meter Menu.

MENU ITEM

DESCRIPTION

Phase Meter Menu	
1. Meter Range	Autorange
2. Select Peak Hold	On
3. Upper Lmt	On
4. Set Upper Lmt	5.00 Rad
5. Lower Lmt	On
6. Set Lower Lmt	3.00 Rad
7. Set Alarm	Off



8616017

1. Meter Range

Selects Meter Range. Select Autorange, 1, 5 or 10 radians.

2. Select Peak Hold

Toggles Peak Hold On or Off.

3. Upper Lmt

Toggles Upper Limit On or Off.

4. Set Upper Lmt

Selects Upper Limit. Range is from 0.00 to 10.00 radians.

5. Lower Lmt

Toggles Lower Limit On or Off.

6. Set Lower Lmt

Selects Lower Limit. Range is from 0.00 to 10.00 radians.

7. Set Alarm

Toggles Alarm between On and Off. Enabled Alarm sounds when an Upper or Lower Limit is exceeded.



## L. DEVIATION METER (RMS)

With the Meter Menu displayed, use the FIELD SELECT Keys to highlight "12. Dev Meter (RMS)" and press the ENTER Key to access the Deviation (RMS) Meter Operation Screen:

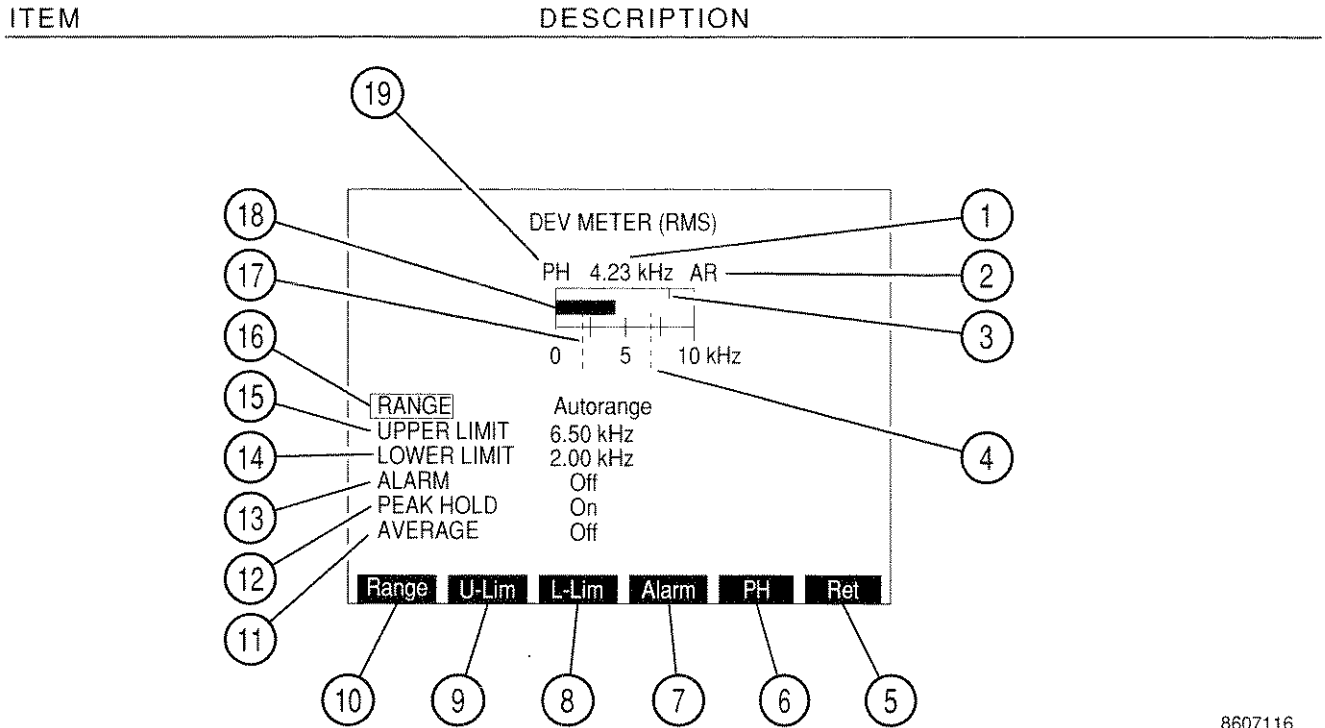

8607116

### 1. Digital Meter Readout

Digital readout of meter in kHz. If PEAK HOLD is On, the readout reads the highest meter deflection.

### 2. AR

Indicator appears above the upper left corner of the meter window if the RANGE is set for Autorange. The Meter Range Scale changes to the next higher scale when the Meter Indicator Bar reaches the edge of the meter window. The meter changes to the next lower scale if the Meter Indicator Bar falls to a level of about 1/2 of the lowest scale division.

### 3. Peak Hold Indicator

Appears when PEAK HOLD is On. Indicator line shows the highest point of meter deflection.

### 4. Upper Limit Indicator

When Upper Limit feature is On, a dotted blue line appears across the meter window at the point on the scale where the limit is set. The indicator appears at the window's upper edge if the limit is set higher than the meter range.

ITEM	DESCRIPTION
5. <u>"Ret"/"ESC" Soft Function Key F6</u>	When editing a parameter, "ESC" is shown. Stops editing process and voids any changes to parameters. "Ret" returns operation to the screen from which meter was called.
6. <u>"PH" Soft Function Key F5</u>	Toggles Peak Hold On or Off.
7. <u>"Alarm" Soft Function Key F4</u>	Toggles Alarm between On and Off. Enabled Alarm sounds when an Upper or Lower Limit is exceeded.
8. <u>"L-Lim" Soft Function Key F3</u>	Activates Lower Limit and selects Lower Limit value. Range is from 0.0 to 10.0 kHz. Lower Limit is turned Off from Deviation RMS Meter Menu.
9. <u>"U-Lim" Soft Function Key F2</u>	Activates Upper Limit and selects Upper Limit value. Range is from 0.0 to 10.0 kHz. Upper Limit is turned Off from Deviation (RMS) Meter Menu.
10. <u>"Range" Soft Function Key F1</u>	Selects Meter Range. Select Autorange, 2, 5 or 10 kHz.
11. <u>AVERAGE</u>	Toggles Average feature On or Off. When On, Meter reads a running average of last 10 readings.
12. <u>PEAK HOLD</u>	Toggles Peak Hold On or Off.
13. <u>ALARM</u>	Toggles Alarm between On and Off. Enabled Alarm sounds when an Upper or Lower Limit is exceeded.
14. <u>LOWER LIMIT</u>	Activates Lower Limit and selects Lower Limit value. Range is from 0.00 to 10.00 kHz. Lower Limit is turned Off from Deviation (RMS) Meter Menu.
15. <u>UPPER LIMIT</u>	Activates Upper Limit and selects Upper Limit value. Range is from 0.00 to 10.00 kHz. Upper Limit is turned Off from Deviation (RMS) Meter Menu.

ITEM	DESCRIPTION
16. <u>RANGE</u>	Selects Meter Range. Select Autorange, 2, 5 or 10 kHz.
17. <u>Lower Limit Indicator</u>	When Lower Limit feature is On, a dotted blue line appears across the meter window at the point on the scale where the limit is set.
18. <u>Meter Indicator Bar</u>	Displays Meter reading. Bar turns red when an Upper or Lower Limit is exceeded. Bar turns green if the current range is surpassed.
19. <u>PH</u>	Appears beside the meter window lower left corner if PEAK HOLD is On.

With the Deviation (RMS) Meter Operation Screen displayed, press the SETUP Key to access the Deviation Meter (RMS) Menu.

MENU ITEM DESCRIPTION

Deviation Meter (RMS) MENU	
1. Meter Range	10 kHz
2. Select Peak Hold	Off
3. Upper Lmt	On
4. Set Upper Lmt	7.00 kHz
5. Lower Lmt	On
6. Set Lower Lmt	3.00 kHz
7. Set Alarm	On
8. Average	Off

8610171

1. Meter Range

Selects Meter Range. Select Autorange, 2, 5 or 10 kHz.

2. Select Peak Hold

Toggles Peak Hold On or Off.

3. Upper Lmt

Toggles Upper Limit On or Off.

4. Set Upper Lmt

Selects Upper Limit. Range is from 0.00 to 10.00 kHz.

5. Lower Lmt

Toggles Lower Limit On or Off.

6. Set Lower Lmt

Selects Lower Limit. Range is from 0.00 to 10.00 kHz.

7. Set Alarm

Toggles Alarm between On and Off. Enabled Alarm sounds when an Upper or Lower Limit is exceeded.

8. Average

Toggles Average feature On or Off. When On, Meters reads a running average of last 10 readings.

## M. PHASE METER (RMS)

With the Meter Menu displayed, use the FIELD SELECT Keys to highlight "13. Phase Meter (RMS)" and press the ENTER Key to access the Phase (RMS) Meter Operation Screen:

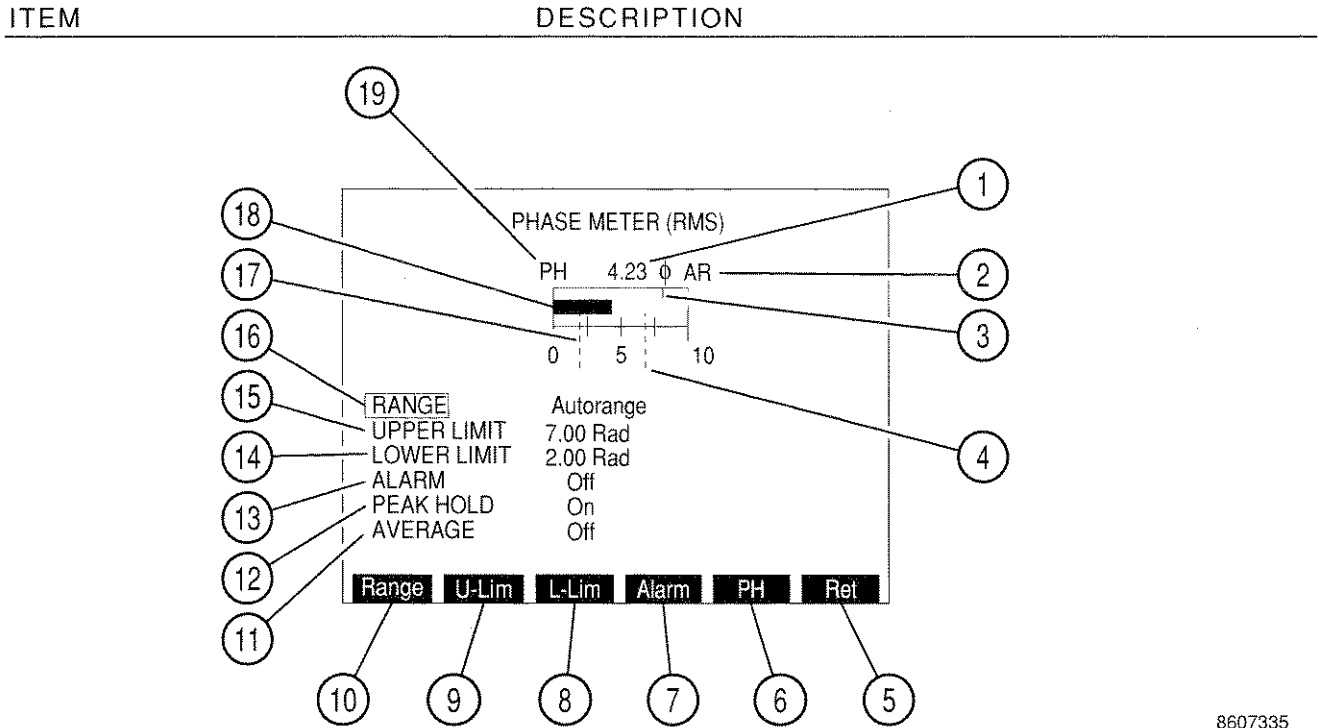

8607335

### 1. Digital Meter Readout

Digital readout of meter in radians. If PEAK HOLD is On, the readout reads the highest meter deflection.

### 2. AR

Indicator appears above the upper left corner of the meter window if the RANGE is set for Autorange. The Meter Range Scale changes to the next higher scale when the Meter Indicator Bar reaches the edge of the meter window. The meter changes to the next lower scale if the Meter Indicator Bar falls to a level of about 1/2 of the lowest scale division.

### 3. Peak Hold Indicator

Appears when PEAK HOLD is On. Indicator line shows the highest point of meter deflection.

### 4. Upper Limit Indicator

When Upper Limit feature is On, a dotted blue line appears across the meter window at the point on the scale where the limit is set. The indicator appears at the window's upper edge if the limit is set higher than the meter range.

ITEM	DESCRIPTION
5. <u>"Ret"/"ESC" Soft Function Key F6</u>	When editing a parameter, "ESC" is shown. Stops editing process and voids any changes to parameters. "Ret" returns operation to the screen from which meter was called.
6. <u>"PH" Soft Function Key F5</u>	Toggles Peak Hold On or Off.
7. <u>"Alarm" Soft Function Key F4</u>	Toggles Alarm between On and Off. Enabled Alarm sounds when an Upper or Lower Limit is exceeded.
8. <u>"L-Lim" Soft Function Key F3</u>	Activates Lower Limit and selects Lower Limit value. Range is from 0.0 to 10.0 radians. Lower Limit is turned Off from Phase (RMS) Meter Menu.
9. <u>"U-Lim" Soft Function Key F2</u>	Activates Upper Limit and selects Upper Limit value. Range is from 0.0 to 10.0 radians. Upper Limit is turned Off from the Phase (RMS) Meter Menu.
10. <u>"Range" Soft Function Key F1</u>	Selects Meter Range. Select Autorange, 1, 5, or 10 radians.
11. <u>AVERAGE</u>	Toggles Average feature On or Off. When On, Meter reads a running average of last 10 readings.
12. <u>PEAK HOLD</u>	Toggles Peak Hold On or Off.
13. <u>ALARM</u>	Toggles Alarm between On and Off. Enabled Alarm sounds when an Upper or Lower Limit is exceeded.
14. <u>LOWER LIMIT</u>	Activates Lower Limit and selects Lower Limit value. Range is from 0.00 to 10.00 radians. Lower Limit is turned Off from Phase (RMS) Meter Menu.
15. <u>UPPER LIMIT</u>	Activates Upper Limit and selects Upper Limit value. Range is from 0.00 to 10.00 radians. Upper Limit is turned Off from Phase (RMS) Meter Menu.

ITEM	DESCRIPTION
16. <u>RANGE</u>	Selects Meter Range. Select Autorange, 1, 5 or 10 radians.
17. <u>Lower Limit Indicator</u>	When Lower Limit feature is On, a dotted blue line appears across the meter window at the point on the scale where the limit is set.
18. <u>Meter Indicator Bar</u>	Displays Meter reading. Bar turns red when an Upper or Lower Limit is exceeded. Bar turns green if the current range is surpassed.
19. <u>PH</u>	Appears beside the meter window lower left corner if PEAK HOLD is On.

With the Phase (RMS) Meter Operation Screen displayed, press the SETUP Key to access the Phase Meter (RMS) Menu.

MENU ITEM DESCRIPTION

Phase Meter (RMS) Menu	
1. Meter Range	10 Rad
2. Select Peak Hold	Off
3. Upper Lmt	On
4. Set Upper Lmt	7.00 Rad
5. Lower Lmt	On
6. Set Lower Lmt	3.00 Rad
7. Set Alarm	On
8. Average	Off

8610214

1. Meter Range  
Selects Meter Range. Select Autorange, 1, 5 or 10 radians.
2. Select Peak Hold  
Toggles Peak Hold between On and Off.
3. Upper Lmt  
Toggles Upper Limit On or Off.
4. Set Upper Lmt  
Selects Upper Limit. Range is from 0.00 to 10.00 radians.
5. Lower Lmt  
Toggles Lower Limit On or Off.
6. Set Lower Lmt  
Selects Lower Limit. Range is from 0.00 to 10.00 radians.
7. Set Alarm  
Toggles Alarm between On and Off. Enabled Alarm sounds when an Upper or Lower Limit is exceeded.
8. Average  
Toggles Average feature On or Off. When On, Meters reads a running average of last 10 readings



## N. AF LEVEL METER (RMS)

With the Meter Menu displayed, use the FIELD SELECT Keys to highlight "14. AF Level Meter (RMS)" and press the ENTER Key to access the AF Level Meter (RMS) Operation Screen:

STEP	PROCEDURE
------	-----------

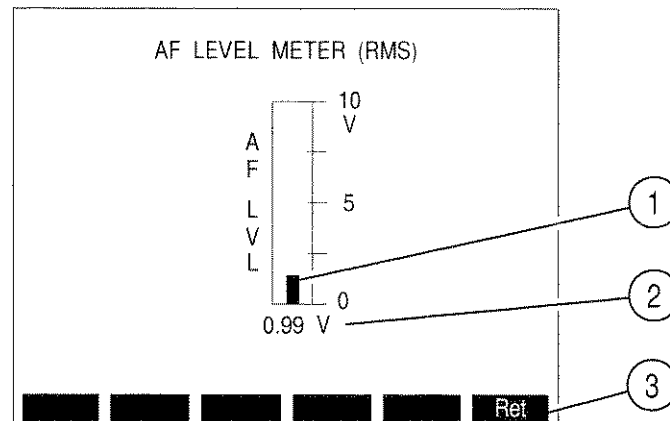

8607315

1. Meter Indicator Bar

Displays Meter reading.

2. Digital Meter Readout

Digital readout of meter in Volts RMS.

3. "Ret" Soft Function Key F6

"Ret" returns operation to the screen from which meter was called.

### 3-3-10 AUXILIARY FUNCTIONS MENU

Auxiliary Functions Menu is accessed by "AUX" Soft Function Key. "AUX" Soft Function Key is accessible from initial Power-up Screen, all Mode Setup Menus and the Meter Menu.

To select a specific function, press the number corresponding to the function on the DATA ENTRY Keypad. Use the following Index of Auxiliary Functions for a description of each function and associated parameters.

MENU ITEM	DESCRIPTION
-----------	-------------

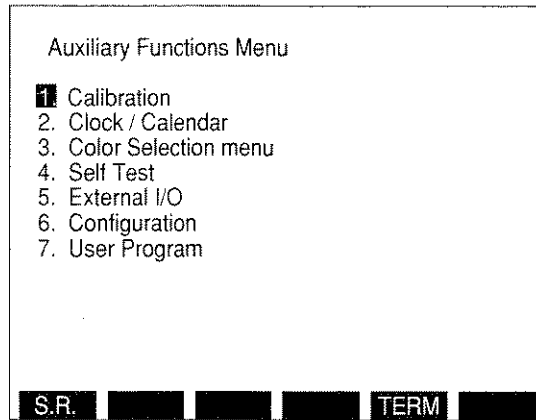

8610329

1. Calibration

Selection accesses submenu for use in calibrating the IFR-1900. Access to submenu requires valid password. Password is set at the factory.

2. Clock/Calendar

Accesses Clock/Calendar Setup Menu.

3. Color Selection Menu

Accesses Color Selection Menu allowing the selection of colors for the color display.

4. Self Test

Accesses Self Test Menu. Self Test is covered in detail in Section 5.

5. External I/O

Accesses External I/O Configuration Menu. Connectors include HOST RS-232, GPIB and SCSI.

6. Configuration

Accesses menu detailing the Test Set configuration including the software versions for the Main CPU, Func Gen Board, Monitor Cntl (Control) Board and Counter Board. The Options number and total run-time (in hours) are also listed. If the SCSI bus is turned On from the External I/O Menu, this menu lists the SCSI bus as active or inactive.

Auxiliary Functions Menu	
1.	Calibrations
2.	Clock / Calendar
3.	Configuration Report
4.	
5.	IFR-1900 1.03
6.	(c) Jul 30 1997 15:04:51
7.	Func Gen Board 1.00
	Monitor Cntl Board 1.00
	Counter Board 1.00
	Options: FF
	Run-time (Hours) 775.3
	1900CSA 1.04

S.R. TERM ESC

03416041

7. User Program

Displays Flash Memory File Directory Screen.

8. "S.R." Soft Function Key F1

Factory use only.

9. "TERM" Soft Function Key F5

Access RS-232 Terminal Operation Screen for operating the Test Set as a RS-232 Host. RS-232 External I/O Configuration Parameters must be set for Host operation. Soft Function Keys in this screen provide special characters (? / + = , " ' : ; \_) to supplement the characters provided by the DATA ENTRY Keypad (29).

Selection of "2. Clock/Calendar" accesses the Clock/Calendar Setup Menu:

MENU ITEM DESCRIPTION

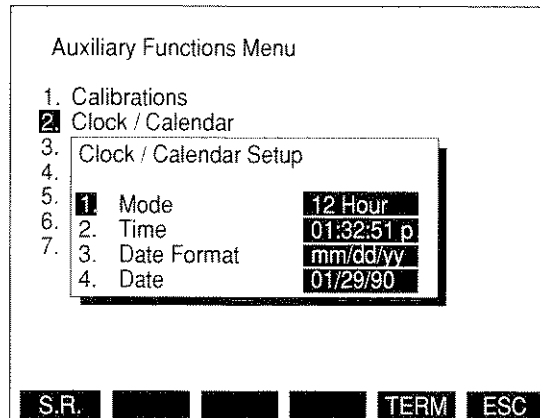

8610330

1. Mode

Selects Clock Mode. Choose from 12 or 24 hour clock formats.

2. Time

Selects current time in hours, minutes and seconds. If in 12 hour clock format, "a" is displayed for am and "p" for pm.

3. Date Format

Selects current date format from mm/dd/yy or dd/mm/yy where mm, dd and yy are two digit representations of month, day and year.

4. Date

Selects current date in digit form listed in Date Format.

**NOTE:** If incorrect data is entered, pressing the "ESC" Soft Function Key allows the user to exit without changing data.

Selection of "3. Color Selection Menu" accesses the Color Selection Menu:

**NOTE:** Only one color set can be on at a time. Selection different from current setting turns current setting off.

MENU ITEM	DESCRIPTION
-----------	-------------

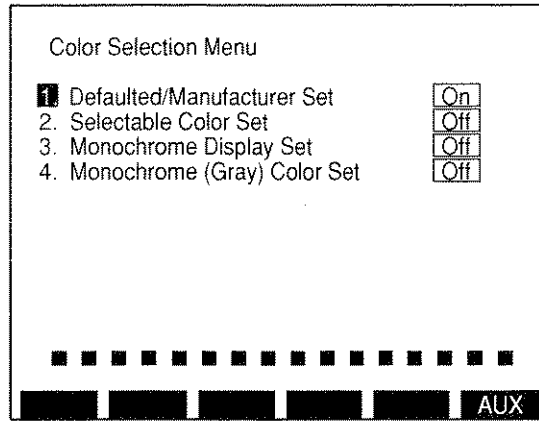

8610023

1. Defaulted/Manufacturer Set

When selected, returns display colors to manufacturers settings.

2. Selectable Color Set

When selected, displays submenu of color sets:

1. Operation Screen Color Set
2. Scope/Analyzer Color Set
3. Menu Screen Color Set
4. Softkey Color Set
5. Cursor Color Set

Selecting specific set accesses another submenu with specific items to be edited for color. When specific item is selected, a cursor appears highlighting currently defined color on the row of colors appearing at the bottom of the menu. Use the DATA SCROLL Spinner or FIELD SELECT Keys to select desired color for item. Press ENTER Key to complete selection.

3. Monochrome Display Set

When selected, configures display colors to Monochrome Display Settings.

4. Monochrome (Gray) Color Set

When selected, configures display colors to Monochrome (Gray) Display Settings.

Selection of "5. External I/O" accesses the External I/O Configure Menu. Through this menu, the user has access to the RS-232 (host), GPIB, SCSI and Printer Configuration Menus. The user can access a specific configuration menu by using the FIELD SELECT Keys and pressing the ENTER Key. The following index outlines the configuration variables and possible settings.

Selection of "1. RS-232 port" accesses the Configure RS-232 Menu:

MENU ITEM	DESCRIPTION
-----------	-------------

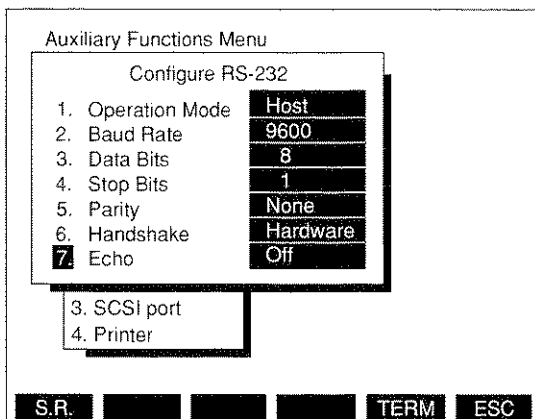

8616013

1. Operation Mode

Selects Off or Host.

2. Baud Rate

Selects rates of 300, 600, 1200, 2400, 4800, 9600, 19200 or 38400 bps.

3. Data Bits

Toggles between 7 and 8 Data Bits.

4. Stop Bits

Toggles between 1 and 2 Stop Bits.

5. Parity

Selects None, Odd, Even, Mark or Space.

6. Handshake

Selects None, Hardware or Xon/Xoff.

7. Echo

Toggles value On or Off.

Selection of "2. GPIB port" accesses the Configure GPIB Menu:

MENU ITEM	DESCRIPTION
-----------	-------------

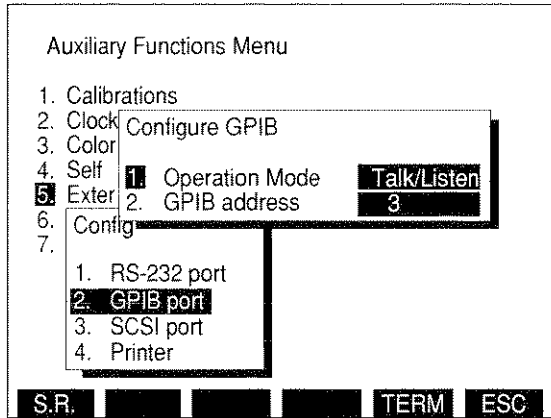

8616015

1. Operation Mode

Selects Off, Talk/Listen, Talk Only or Controller.

2. GPIB address

Selects Test Set address for GPIB bus operation. Select from 0 to 31.

Selection of "3. SCSI port" accesses the Configure SCSI Menu:

MENU ITEM	DESCRIPTION
-----------	-------------

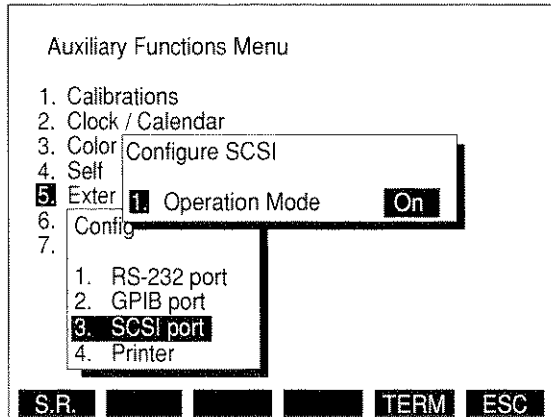

8616016

1. Operation Mode

Selects On or Off.

Selection of "4. Printer" accesses the Printer submenu.

MENU ITEM

DESCRIPTION

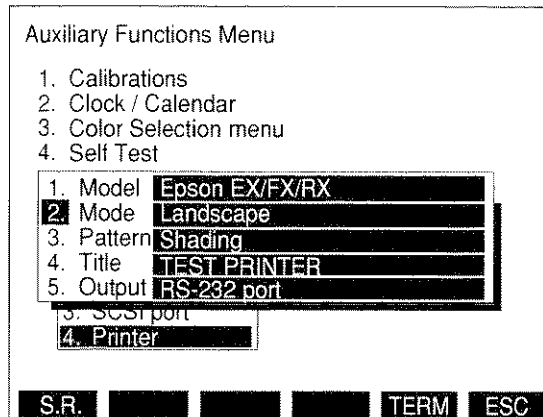

8616014

1. Printer

Selects Epson EX/FX/RX, HP LaserJet II, IBM Graphics or HP ThinkJet.

2. Mode

Selects Landscape or Portrait.

3. Pattern

Selects Shading or Black and White.

4. Title

Enters title of up to 14 characters.

5. Output

Selects HOST RS-232, PRINTER (parallel) or GPIB Connector.



Selection of "7. User Program" accesses the Flash Memory File Directory:

ITEM	DESCRIPTION
------	-------------

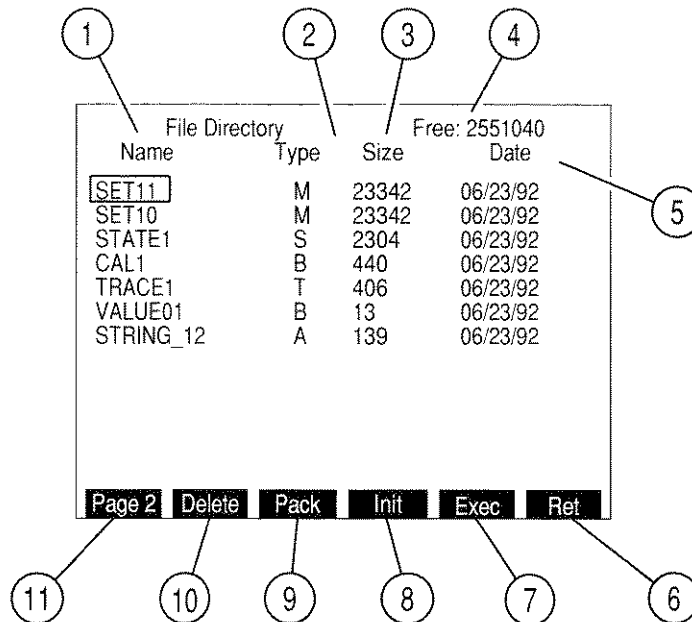

8617101

1. File Name

Name of file stored in Flash Memory. 1024 file names are allowed. Names can be used only once unless Flash Memory is re-initialized (initializing Flash Memory erases all files stored in Flash Memory). File names start with a letter but rest of characters can be numbers and underscore. File names are limited to 8 characters.

2. File Type

Type of file stored in Flash Memory. Following are the 5 types:

ASCII	Variable storage.
Binary	Calibration Data storage.
State	Test Set State storage.
Trace	Oscilloscope or Spectrum Analyzer trace storage.
Macro	Macro storage.

3. File Size

File size in bytes.

4. Free Memory Size

Available bytes in Flash Memory.

ITEM	DESCRIPTION
5. <u>File Date</u>	Date file stored in Flash Memory.
6. <u>"Ret" Soft Function Key F6</u>	Returns operation to Auxiliary Functions Menu.
7. <u>"Exec"/"Load" Soft Function Key F5</u>	"Exec" appears when cursor is on Macro Type file. Loads file into Test Set memory and executes designated macro. "Load" appears when cursor is on State or Binary Type file. Loads Test Set State or Calibration Data into Test Set memory.
8. <u>"Init" Soft Function Key F4</u>	Initializes Flash Memory. Initializing erases all files stored in Flash Memory.
9. <u>"Pack" Soft Function Key F3</u>	Packs Flash Memory. Pack releases memory space taken by deleted files. <b>NOTE:</b> Files may be lost if power is removed from Test Set during Pack operation.
10. <u>"Delete" Soft Function Key F2</u>	Deletes file the cursor is on. <b>NOTE:</b> To recover Flash Memory space held by deleted files, Pack operation must be performed.
11. <u>"Page" Soft Function Key F1</u>	When the number of User Programs exceeds the maximum that can be displayed on a single screen, "Page" appears indicating that one or more programs are accessible on one or more following screens. Pressing "Page" advances through each successive screen until returning to the screen displaying the first page.

## 4-1 GENERAL

The IFR-1900 has six Operation Modes accessed through the MODE Keys. Editing operation screens is done in one of the following ways:

- Moving screen cursor to a parameter and pressing ENTER Key to access the data field.
- Accessing the parameter data field using Soft Function Keys.
- Accessing and editing parameters on the Operation Screen's Setup Menu and Submenus.

Due to the number of Soft Function Key Definitions, only cursor/ENTER Key access on Operation Screens is discussed in the following paragraphs unless a parameter is only accessed through Soft Function Keys or Setup Menus.

While editing parameter data fields on Operation Screens or Menus, Soft Function Key F6 Definition shows "ESC." Pressing "ESC" Soft Function Key F6 at this time allows escape from the data field without changing its data.

When editing the Setup Menu of an Operation Screen or a meter accessed from an Operation Screen, one Soft Function Key Definition (F5 on menus, F6 on meters) shows "Ret." Pressing "Ret" Soft Function Key returns operation to the last accessed operation screen.

### 4-1-1 PARAMETER MEMORY OPERATION

The IFR-1900 allows storage and recall of 9 sets of parameters within each operation mode or "globally" from the Auxiliary Functions Menu.

#### A. OPERATION SCREENS PARAMETER STORAGE AND RECALL

STEP	PROCEDURE
------	-----------

1. To store a set of parameters for an Operation Screen:

- Press STORE MEMORY Key to access the Operation Screen Store Parameters Menu. Use DATA ENTRY Keypad (29) (Figure 3-1) to select a memory location (1 to 9). A data field appears asking for a title to be entered:

Store Parameters Menu (Duplex)

1. **1**
- 2.
3. Enter Title. (20 chars max)
4.
- 5.
- 6.
- 7.
- 8.
- 9.

ESC

8610103

- Use DATA ENTRY Keypad (29) (Figure 3-1) to enter a title up to 20 characters in length and press ENTER Key.
  - Press SHIFT Key to toggle DATA ENTRY Keypad (29) (Figure 3-1) to either numeric or alphabetic values. Numeric values are printed on the keys and alphabetic values are printed above keys in blue.
  - The DEL (Delete) EDIT Key (13) (Figure 3-1) causes a character to be deleted. CE (Clear Entry) EDIT Key (13) (Figure 3-1) causes a blank space to be entered.
  - If a set of parameters are already stored under number chosen, a data field appears with message "Entry Exists. Delete it?". Press STORE MEMORY Key (16) (Figure 3-1) to toggle entry between yes and no and press ENTER Key.
  - If yes is chosen, use DATA ENTRY Keypad (29) (Figure 3-1) to enter a new title. Press ENTER Key.
  - If no is chosen, use DATA ENTRY Keypad (29) (Figure 3-1) to select another memory location or press "Ret" Soft Function Key F5 to return to operation screen.
2. To recall a set of parameters for an Operation Screen:
- Press RCL (Recall) MEMORY Key to access the Operation Screen Recall Parameters Menu. Use DATA ENTRY Keypad (29) (Figure 3-1) to select memory location. A "Recall?" message and data field appears:

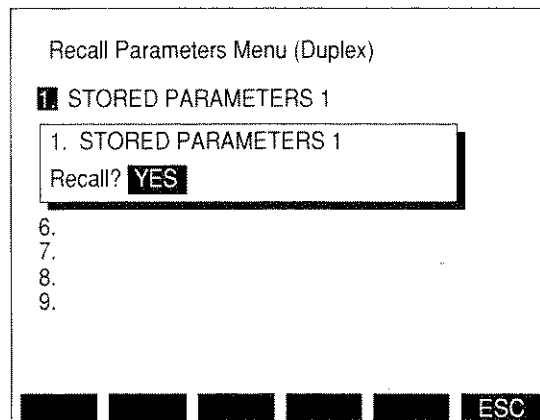

8610105

**NOTE:** If nothing is stored under entry chosen, a "Does Not Exist" message briefly appears. Use DATA ENTRY Keypad (29) (Figure 3-1) to select another entry or press "Ret" Soft Function Key F5 to return to operation screen.

- Press RCL (Recall) MEMORY Key (16) (Figure 3-1) to toggle between yes and no, and press ENTER Key to activate. If no is chosen, use DATA ENTRY Keypad (29) (Figure 3-1) to select another memory location or press "Ret" Soft Function Key F5 to return to operation screen.

## B. SYSTEM ("GLOBAL") PARAMETER STORAGE AND RECALL

The storage and recall of current parameters of all Modes (as reflected by the MODE Keys [27]) is performed by the following procedure:

STEP	PROCEDURE
------	-----------

1. To store a set of parameters:

- Press MTRS MODE Key (27) to access the Meter Menu.
- Press "AUX" Soft Function Key F6 to access the Auxiliary Function Menu.
- Press STORE MEMORY Key to access the System Store Parameters Menu. Use DATA ENTRY Keypad (29) (Figure 3-1) to select a memory location (1 to 9). A data field appears asking for a title to be entered:

The screenshot shows a terminal window titled "Store Parameters Menu (System)". On the left, there is a vertical list of numbers 1 through 9. A cursor is positioned next to the number 1. To the right of the list is a rectangular data entry field with the text "Enter Title. (20 chars max)" inside. At the bottom of the window, there is a row of keys: a series of dark keys followed by "AUX" and "ESC".

03416130

- Use DATA ENTRY Keypad (29) (Figure 3-1) to enter a title up to 20 characters in length and press ENTER Key.
  - Press SHIFT Key to toggle DATA ENTRY Keypad (29) (Figure 3-1) to either numeric or alphabetic values. Numeric values are printed on the keys and alphabetic values are printed above keys in blue.
  - The DEL (Delete) EDIT Key (13) (Figure 3-1) causes a character to be deleted. CE (Clear Entry) EDIT Key (13) (Figure 3-1) causes a blank space to be entered.
- If a set of parameters are already stored under number chosen, a data field appears with message "Entry Exists. Delete it?". Press STORE MEMORY Key (16) (Figure 3-1) to toggle entry between yes and no and press ENTER Key.
  - If yes is chosen, use DATA ENTRY Keypad (29) (Figure 3-1) to enter a new title. Press ENTER Key.
  - If no is chosen, use DATA ENTRY Keypad (29) (Figure 3-1) to select another memory location or press "AUX" Soft Function Key F5 to return to Auxiliary Functions Menu.

**STEP****PROCEDURE**

2. To recall a set of parameters:

- Press RCL (Recall) MEMORY Key to access the System Recall Parameters Menu. Use DATA ENTRY Keypad (29) (Figure 3-1) to select memory location. A "Recall?" message and data field appears:

**NOTE:** If nothing is stored under entry chosen, a "Does Not Exist" message briefly appears. Use DATA ENTRY Keypad (29) (Figure 3-1) to select another entry or press "AUX" Soft Function Key F5 to return to operation screen.

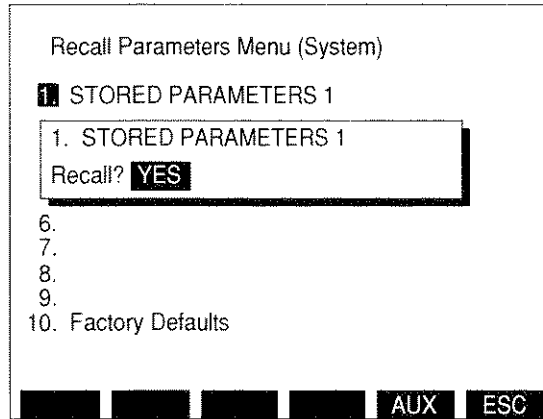

03416131

- Press RCL (Recall) MEMORY Key (16) (Figure 3-1) to toggle between yes and no, and press ENTER Key to activate. If no is chosen, use DATA ENTRY Keypad (29) (Figure 3-1) to select another memory location or press "AUX" Soft Function Key F5 to return to Auxiliary Functions Menu.

3. To recall Factory Defaults:

- Perform Step 2 previously described and select "10. Factory Defaults."

## 4-1-2 PRINTING DISPLAY SCREENS

A screen print is performed using the following instructions:

**STEP****PROCEDURE**

1. Verify Printer parameters are set correctly (see 6-2).
2. Connect Printer to HOST RS-232 Connector (39) or GPIB Connector (37) (Figure 3-2).
3. Press PRINT SCRN TEST CONTROL Key (28) (Figure 3-1). If Oscilloscope or Analyzer Operation Screen is displayed, a submenu appears listing print and plot options. Press 1 DATA ENTRY Key (29) (Figure 3-1) to print screen. To plot Oscilloscope Trace, see 4-6. To plot Analyzer Trace, see 4-7.
4. To stop printing before printing is finished, press STOP TEST CONTROL Key (28) (Figure 3-1).

## 4-2 RF GENERATOR OPERATION

### 4-2-1 RF GENERATOR GENERAL OPERATION

Operate RF Generator using the following procedure:

STEP PROCEDURE

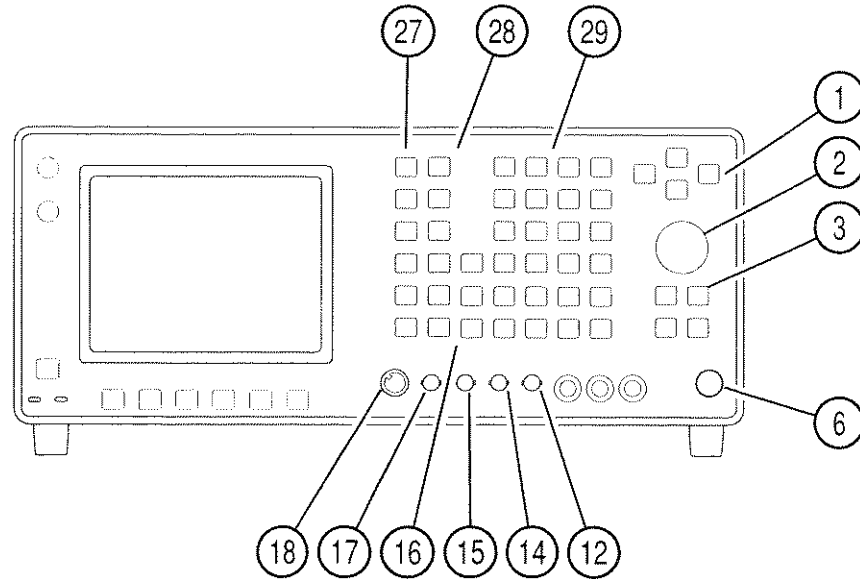

03407009

1. Press RF GEN MODE Key (27) to access RF Generator Operation Screen.

**NOTE:** When RF Generator Operation Screen is displayed, a signal >100 mW applied to T/R Connector (6) causes Receiver Operation Screen to be displayed.

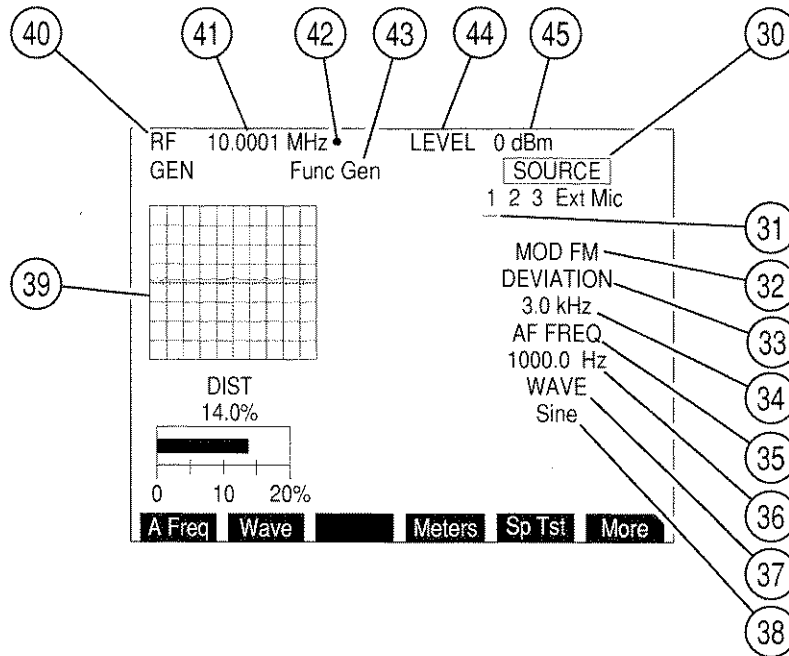

03416122

2. Move cursor to RF (40) and press ENTER Key to access data field (41). Use DATA ENTRY Keypad (29) to enter a frequency (in MHz) and press ENTER Key to activate entered frequency.
3. Move cursor to LEVEL (44) and press ENTER Key to access Output Level data field (45). Use DATA ENTRY Keypad (29) to enter level and press ENTER Key to activate Output Level. If necessary, press +/- DATA ENTRY Key (29) to place a "-" in data field.
4. Move cursor to SOURCE (30) and press ENTER Key to access Modulation Sources. Use FIELD SELECT ← and → Keys (1) to place cursor over desired source and use DATA SCROLL ↑ or ↓ Keys (3) to select desired Modulation Type (32). White indicates OFF, red indicates AM, yellow indicates FM and green indicates PM. Last selected Modulation Type is displayed with Modulation Type Callout (32). Press ENTER Key to accept SOURCE selection.

**NOTE:** If no source is active, data field cursor (31) appears under Source 1 Callout. If more than one source is on, last selected source is indicated by an underline. Source 1 refers to AF Generator 1, Source 2 refers to AF Generator 2, Source 3 refers to Signaling Formats, Ext refers to signals received at EXT MOD IN Connector (17) and Mic refers to signals received at MIC/ACC Connector (18).

5. Move cursor to DEVIATION or MODULATION (33) and press ENTER Key to access data field (34). Use DATA ENTRY Keypad (29) to enter digits of desired deviation frequency or modulation percentage. Press ENTER Key to activate deviation or modulation.

**NOTE:** When Ext Source is selected, Modulation Level setting assumes the modulating signal applied to the EXT MOD IN Connector (17) is 3.54 VRMS. Modulation Level setting is set higher for lower EXT MOD IN Connector (17) input voltages to achieve same modulation level as per following equation:

$$\begin{array}{rcccl} \text{Modulation} & & \text{EXT MOD IN} & & \text{Actual} \\ \text{Level setting} & \times & \text{Connector} & \div & \text{Modulation} \\ \text{(kHz, \%, rad)} & & \text{Input (VRMS)} & & \text{Level} \\ & & & + 3.54 & = \end{array}$$

6. If Source 1 or 2 is last selected Source:
  - Move cursor to AF FREQ (35) and press ENTER Key to access data field (36). Use DATA ENTRY Keypad (29) to enter desired frequency and press ENTER Key to activate AF Frequency.
  - Move cursor to WAVE (37) and press ENTER Key to access data field (38). Press DATA SCROLL ↑ or ↓ Keys (3) until desired selection appears in data field and press ENTER Key to activate Wave Shape.



7. If Source 3 is not last selected Source, proceed to Step 18. If Source 3 is last selected Source, Operation Screen appears as follows:

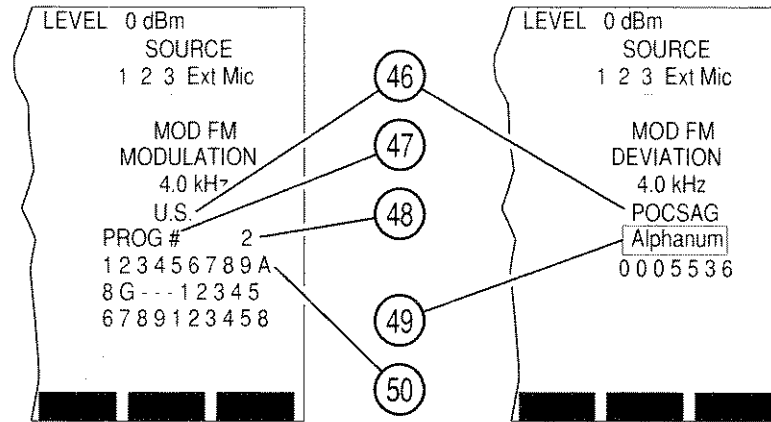

8617080

8. If DTMF is the Signaling Format:
- Move cursor to DIRECT ENTRY/PROG # (47). Press ENTER Key to toggle between Direct Entry and Program features.
  - If PROG is selected, move cursor to Program Number (48) and use DATA ENTRY Keypad (29) to select a programmed sequence. Press ENTER Key.
  - If DIRECT ENTRY is selected, move cursor to sequence (50) and use DATA ENTRY Keypad (29) to enter desired sequence. Press ENTER Key.
9. If DTMF is not the Signaling Format, move cursor to Signaling Code (46) and use DATA SCROLL Keys  $\uparrow$  and  $\downarrow$  (3) to select a Signaling Code in the current Signaling Format. Press ENTER Key.
- If POCSAG or Tone Remote is selected as Signaling Code, move cursor to POCSAG or Tone Remote Function Callout (49). Use DATA SCROLL  $\uparrow$  and  $\downarrow$  Keys (3) to select a function and press ENTER Key.
  - If a Signaling Code other than DTMF, POCSAG or Tone Remote is selected:
    - Move cursor to DIRECT ENTRY/PROG # (47). Press ENTER Key to toggle between Direct Entry and Program features.
    - If PROG is selected, move cursor to Program Number (48) and use DATA ENTRY Keypad (29) to select a programmed sequence. Press ENTER Key.
    - If DIRECT ENTRY is selected, move cursor to sequence (50) and use DATA ENTRY Keypad (29) to enter desired sequence. Press ENTER Key.
10. To continuously generate Code, press GO TEST CONTROL Key (28). To stop generating Code, press STOP TEST CONTROL Key (28). To generate Code one sequence at a time, press SGL STEP TEST CONTROL Key (28).

- To select a different Signaling Format, press SETUP Key to display Generator Menu. Press 3 DATA ENTRY Key (29) to display Signaling Format Menu:

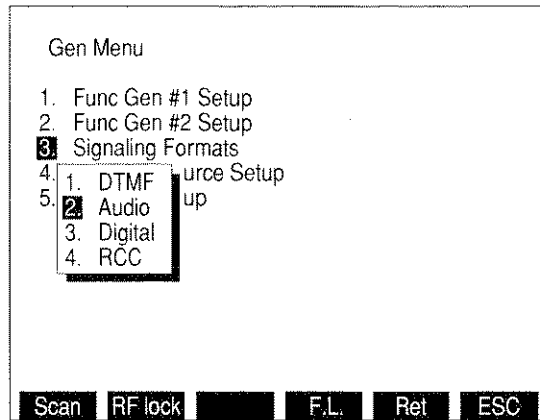

8610335

- Use DATA ENTRY Keypad (29) to select a Signaling Format and press "Ret" Soft Function Key F5.
- To program a Signaling Code sequence, press SETUP Key to display Generator Menu. Press 3 DATA ENTRY Key (29) to display Signaling Format Menu. Use DATA ENTRY Keypad (29) to select a Signaling Format.
- If DTMF is selected, DTMF Signaling Menu appears:

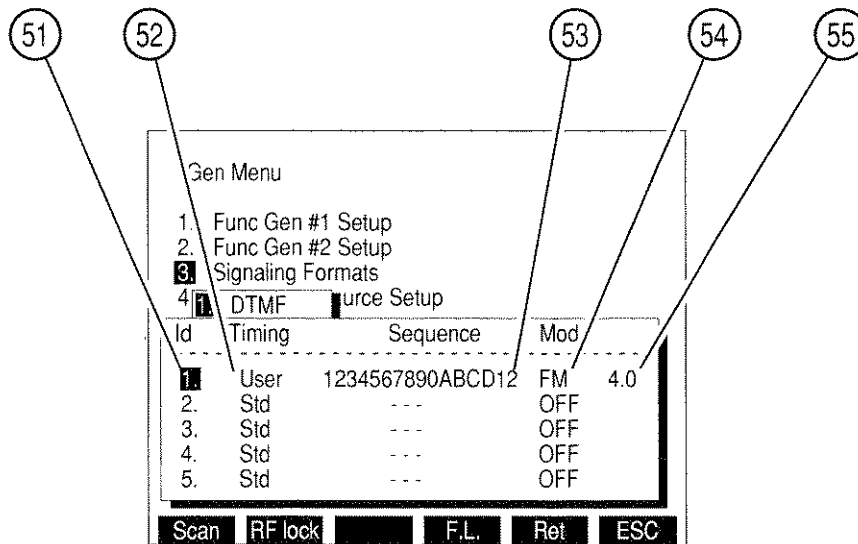

8607317

- Select Id (51) of Sequence to be edited using FIELD SELECT ↑ and ↓ Keys (1).
- Move cursor to Timing column (52) and use DATA SCROLL ↑ and ↓ Keys (3) to select Std (Standard) or User. Press ENTER Key.
- If User is chosen, data fields appear for Mark Timing and Space Timing:

- Press 1 DATA ENTRY Key (29) and use DATA ENTRY Keypad (29) to enter Mark Timing. Press ENTER Key.
- Press 2 DATA ENTRY Key (29) and use DATA ENTRY Keypad (29) to enter Space Timing. Press ENTER Key.
- Press "ESC" Soft Function Key F6.
- Move cursor to Selection column (53) and enter a sequence using DATA ENTRY Keypad (29) and press ENTER Key.

**NOTE:** Pressing SHIFT Key toggles DATA ENTRY Keypad (29) between numeric and alphabetic characters.

- Move cursor to Mod column (54) and use DATA SCROLL ↑ and ↓ Keys (3) to select Modulation Type and press ENTER Key.
- Move cursor to Modulation Level (55) and use DATA ENTRY Keypad (29) to select Modulation Level and press ENTER Key.
- When all desired sequences are entered, press "Ret" Soft Function Key F5 to return to RF Generator Operation Screen.

15. If Audio is selected as Signaling Format, Audio Code Menu appears:

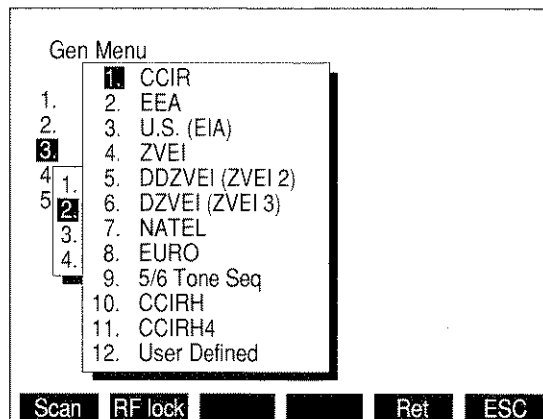

8610081

- Use FIELD SELECT Keys (1) to select an Audio Code and press ENTER Key. Audio Code Sequence Menu appears:

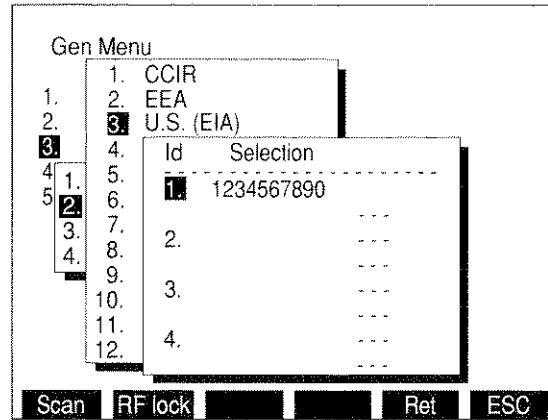

8610082

- Use FIELD SELECT Keys (1) to select an Id (1 to 16) and press ENTER Key.
- Use DATA ENTRY Keypad (29) to enter a sequence and press ENTER Key.  
**NOTE:** Pressing SHIFT Key toggles DATA ENTRY Keypad (29) between numeric and alphabetic characters.
- If "12. User Defined" is selected as Audio Code, Audio Code User Defined Menu appears:

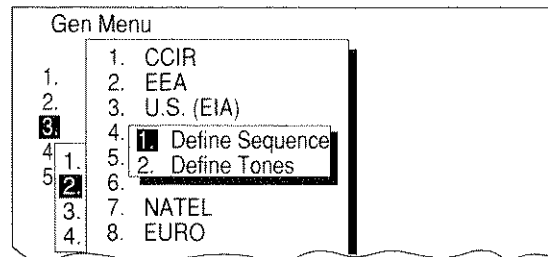

8610159

- Press 2 DATA ENTRY Key (29) to display following menu:

Gen Menu

1. 1. CCIF  
2. 2. EEA  
3. 3. U.S. EIA  
4. 4.  
5. 5.

Id	Tone(Hz)	Duration (ms)
0	5.0	20
1	10.0	20
2	20.0	20
3	30.0	20
4	40.0	20
5	50.0	20
6	60.0	20
7	70.0	20

Scan RF lock Fill Ret ESC

8607119

- Move cursor to Tone(Hz) column (58) of desired Id (57) (1 of 30) and use DATA ENTRY Keypad (29) to select a frequency. Press ENTER Key.
- Move cursor to Duration(ms) column (59) and use DATA ENTRY Keypad (29) to select duration. Press ENTER Key.
- With cursor in Tone(Hz) (58) column or Duration(ms) (59) column, press "Fill" Soft Function Key F4 to fill column below cursor with value highlighted by cursor.
- When all desired tones are defined, press "ESC" Soft Function Key F6 to return to Audio Code User Defined Menu.
- Press 1 DATA ENTRY Key (29) to access Audio Code Sequence Menu. User Defined Sequences are selected as other Audio Code Sequences. When all desired sequences have been entered, press "Ret" Soft Function Key F5 to return to RF Generator Operation Screen.

16. If Digital is selected as the Signaling Format, Digital Code Menu appears. Use DATA ENTRY Keypad (29) to select a Digital Code Type.

- If DCS or DCS INV is selected as the Digital Code Type, DCS Code Menu appears:

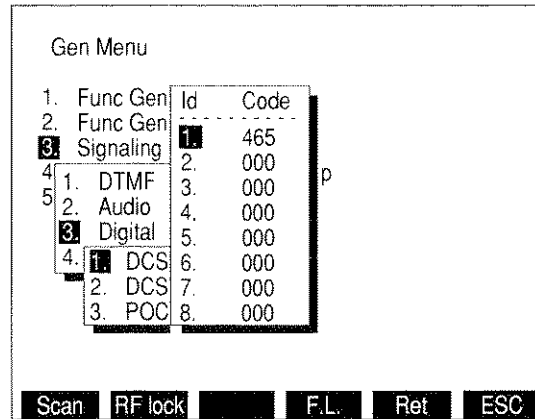

8610340

- Use FIELD SELECT Keys (1) to select an Id (1 of 16) and press ENTER Key.
- Use DATA ENTRY Keypad (29) to enter a sequence and press ENTER Key. When all desired sequences are entered, press "Ret" Soft Function Key F5 to return to RF Generator Operation Screen.
- If POCSAG is selected as the Digital Code Type, POCSAG Menu appears:

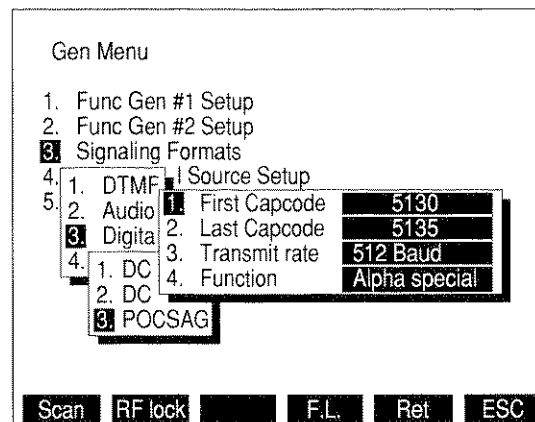

8616004

- Press 1 DATA ENTRY Key (29) to access Capcode 1. Use DATA ENTRY Keypad (29) to enter Starting Capcode and press ENTER Key.
- Press 2 DATA ENTRY Key (29) to access Capcode 2. Use DATA ENTRY Keypad (29) to enter Ending Capcode and press ENTER Key.
- Press 3 DATA ENTRY Key (29) to select Transmit rate submenu. Choose 512 Baud or 1200 Baud.

- Press 4 DATA ENTRY Key (29) to display POCSAG Function Menu:

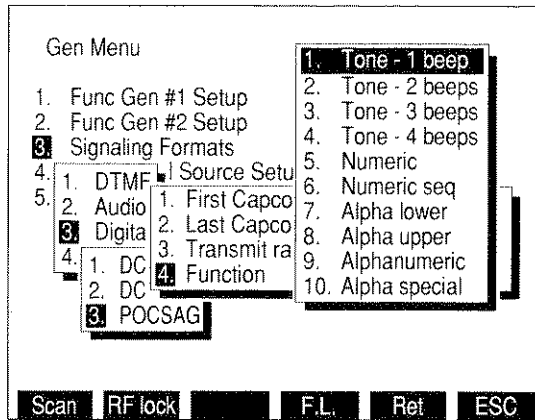

8610359

- Use FIELD SELECT Keys (1) to select a Function Type and press ENTER Key. Press "Ret" Soft Function Key F5 to return to RF Generator Operation Screen.

17. If RCC is selected as the Signaling Format, RCC Code Menu appears. Use DATA ENTRY Keypad (29) to select a RCC Code.

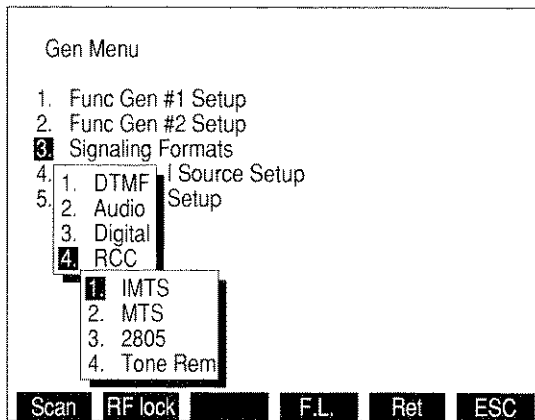

8610341

- If IMTS, MTS or 2805 is selected, RCC IMTS, MTS and 2805 Menu appears:

The screenshot shows the 'Gen Menu' interface. A list of options is displayed: 1. Func Gen #1, 2. Func Gen #2, 3. Signaling For, 4. 1. DTMF, 5. 2. Audio, 6. 3. Digital, 7. 4. RCC. The 'RCC' option is highlighted with a cursor. Below this, a sub-menu is shown with options: 1. IMTS, 2. MTS, 3. 2805, 4. Tone Rem. The 'IMTS' option is highlighted. To the right, a table with columns 'Id' and 'Sequence' is visible, with the first row containing '1.' and '1234567891'. At the bottom, a row of soft function keys is shown: Scan, RF lock, F.L., Ret, and ESC.

8610342

- Use FIELD SELECT Keys (1) to select an Id and press ENTER Key.
- Use DATA ENTRY Keypad (29) to enter a sequence and press ENTER Key.
- If 2805 is chosen, "Tone" Soft Function Key F3 appears. To edit 2805 frequency, press "Tone" Soft Function Key F3 and use DATA ENTRY Keypad (29) to enter frequency. Press ENTER Key.
- When all desired sequences have been entered, press "Ret" Soft Function Key F5 to return to RF Generator Operation Screen.
- If Tone Rem (Remote) is selected, Tone Rem Function Menu appears:

The screenshot shows the 'Gen Menu' interface with the 'Tone Rem Function' sub-menu open. The sub-menu lists 11 options: 1. 2050 (Monitor), 2. 1950 (F1), 3. 1850 (F2), 4. 1750 (R2 Mute), 5. 1650 (R2 Unmute), 6. 1550 (Repeater Off), 7. 1450 (Repeater On), 8. 1350 (Wild Card 1 On), 9. 1250 (Wild Card 1 Off), 10. 1150 (Wild Card 2 On), 11. 1050 (Wild Card 2 Off). The '1950 (F1)' option is highlighted. The 'RCC' option in the main menu is also highlighted. At the bottom, the same row of soft function keys is shown: Scan, RF lock, F.L., Ret, and ESC.

8610366

- Use FIELD SELECT Keys (1) to select a Tone Remote Function and press ENTER Key.
- Press "Ret" Soft Function Key F5 to return to RF Generator Operation Screen.



18. If an Oscilloscope or Spectrum Analyzer display is desired for RF Generator Screen or if this feature is desired in a different size:

- Press "More" Soft Function Key F6 until "Disp" Soft Function Key F1 appears. Press "Disp" Soft Function Key F1.
- A menu appearing in lower left corner of screen displays following options:

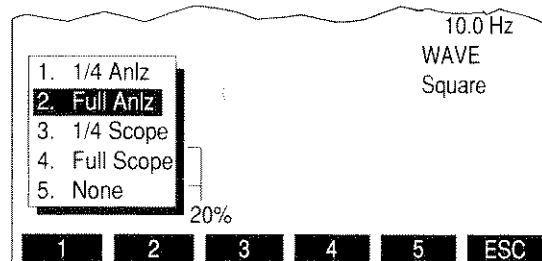

8617084

Select desired screen option using DATA ENTRY Keypad (29).

**NOTE:** 1/4 size Analyzer Screen parameters are edited by selecting full size Analyzer display, editing parameters and reselecting 1/4 size Analyzer display.

19. If "2. Full Anlz" is selected:

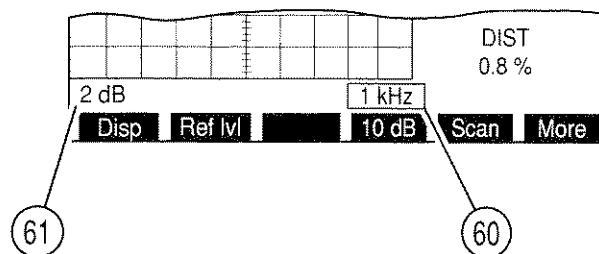

8607108

- Move cursor to Analyzer Scan Width (60) and press ENTER Key to access the data field. Press DATA SCROLL  $\uparrow$  or  $\downarrow$  Keys (3) until desired selection appears in data field and press ENTER Key to activate Scan Width desired.
- Move cursor to Units/Division Factor (61) and press ENTER Key to toggle value between 2 and 10 dB.

20. If "3. 1/4 Scope" is selected:

- Move cursor to Oscilloscope Input (43) and press ENTER Key to access the data field. Press DATA SCROLL  $\uparrow$  or  $\downarrow$  Keys (3) until desired selection appears in data field, and press ENTER Key.

**NOTE:** Remaining Oscilloscope parameters are edited by selecting full size Scope display, changing parameters and reselecting 1/4 size Scope display.

21. If "4. Full Scope" is selected:

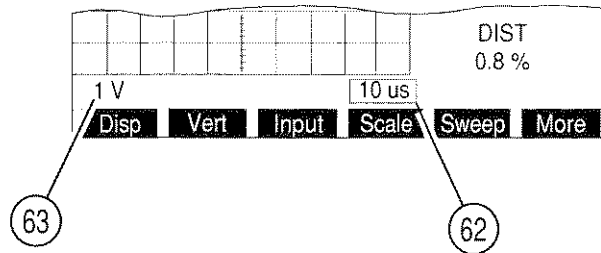

8607106

- Move cursor to Oscilloscope Input (43) and press ENTER Key to access the data field. Press DATA SCROLL ↑ or ↓ Keys (3) until desired selection appears in data field and press ENTER Key.
  - Move cursor to Oscilloscope Sweep Rate (62) and press ENTER Key to access the data field. Press DATA SCROLL ↑ or ↓ Keys (3) until desired selection appears in data field and press ENTER Key.
  - Move cursor to Oscilloscope Scale (63) and press ENTER Key to access the data field. Press DATA SCROLL ↑ or ↓ Keys (3) until desired selection appears in data field and press ENTER Key.
  - If needed, press "More" Soft Function Key F6 until "Vert" Soft Function Key F2 appears. Press "Vert" Soft Function Key F2. Use DATA SCROLL Spinner (2) or DATA SCROLL ↑ or ↓ Keys (3) to adjust vertical position of Oscilloscope Trace. Press ENTER Key.
22. If Modulation Source routed to AUDIO OUT Connector (14) or DEMOD OUT Connector (12) is desired, or if Speaker use is desired, press SETUP Key to display RF Generator Menu. Press 5 DATA ENTRY Key (29) to access RF Generator Setup Menu:

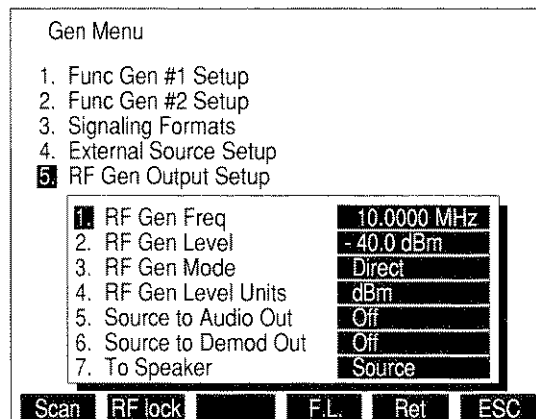

03416118

- Press 5 DATA ENTRY Key (29) as needed to enable or disable RF Generator Output to AUDIO OUT Connector (14).
- Press 6 DATA ENTRY Key (29) to enable or disable RF Generator Output to DEMOD OUT Connector (12).

**STEP****PROCEDURE**

- Press 7 DATA ENTRY Key (29) and use DATA ENTRY Keypad (29) to select a signal to be routed to Speaker.

**NOTE:** Routing Source to Speaker disables SINAD and Distortion Meters.

- Press "Ret" Soft Function Key F5 to return to RF Generator Operation Screen.

23. To display SINAD, Distortion, AF Level Meter or Digital Multimeter, press "More" Soft Function Key F6 until "Meters" Soft Function Key F4 appears. Press "Meters" Soft Function Key F4 to display a submenu listing available meters. Use DATA ENTRY Keypad (29) to select a meter. To access a meter's operation screen, move cursor to Meter Callout on the current operation screen and press ENTER Key.

- For SINAD Meter Operation Procedures, see 4-8-7.
- For Distortion Meter Operation Procedures, see 4-8-6.
- For Digital Multimeter Operating Procedures, see 4-8-10.
- For details on AF Level Meter, see 4-8-14.

**NOTE:** SINAD, Distortion and AF Level Meters measure only SINAD/BER IN Connector (15) Input. DMM measures only DMM Connector Input.

**Channel Mode**

24. To operate RF Generator in Channel Mode, press SETUP Key and 5 DATA ENTRY Key (29) to display RF Generator Setup Menu. Press 3 DATA ENTRY Key (29) to display RF Generator Mode submenu. Press 2 DATA ENTRY Key (29) to select channel.

- Press "Chan" Soft Function Key F2 to display Channel Format Menu. Use DATA ENTRY Keypad (29) to select a Channel Format.
- Press "Ret" Soft Function Key F5 to return to Receiver Operation Screen. RF Generator Frequency is displayed by channel number.
- See the following Appendices for listings of cellular channels and corresponding frequencies:

CHANNEL FORMAT	APPENDIX
NADC/NAMPS	B
E-TACS	C

**Direct Mode**

25. To operate RF Generator in Direct Mode, press "More" Soft Function Key F6 until "Mode" Soft Function Key F1 appears. Press "Mode" Soft Function Key F1 and press 1 DATA ENTRY Key (29) to select Direct Mode.

## Frequency Scan Mode

26. To operate RF Generator Frequency Scan Mode, press SETUP Key to access Generator Menu. Press "Scan" Soft Function Key F1 to access RF Generator Frequency Scan Menu:

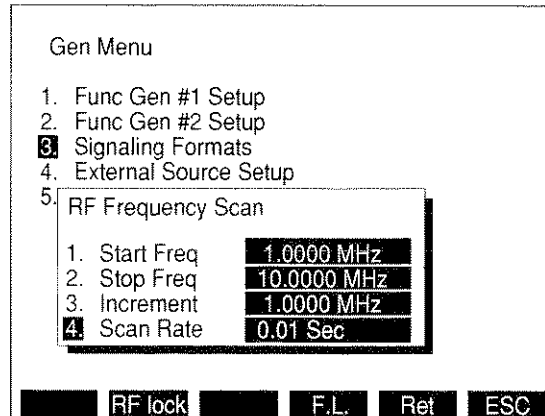

8610333

- Press 1 DATA ENTRY Key (29) to access Starting Frequency. Use DATA ENTRY Keypad (29) to enter Starting Frequency and press ENTER Key.
  - Press 2 DATA ENTRY Key (29) to access Stopping Frequency. Use DATA ENTRY Keypad (29) to enter Stopping Frequency and press ENTER Key.
  - Press 3 DATA ENTRY Key (29) to access Increment. Use DATA ENTRY Keypad (29) to enter Increment and press ENTER Key.
  - Press 4 DATA ENTRY Key (29) to access Scan Rate. Use DATA ENTRY Keypad (29) to enter Scan Rate. Press ENTER Key and "Ret" Soft Function Key F5 to return to Operation Screen.
  - Press GO TEST CONTROL Key (28) to start RF Generator Scan. Press STOP TEST CONTROL Key (28) to stop Scanning. Pressing GO TEST CONTROL Key (28) again resumes scanning operation. Press SGL STEP TEST CONTROL Key (28) to single step through scanning operation one increment at a time.
  - To return RF Generator Operation Mode to Direct Operation, press "More" Soft Function Key F6 until "Mode" Soft Function Key F1 appears. Press "Mode" Soft Function Key F1 and press 1 DATA ENTRY Key (29) to select RF Generator Direct Operation Mode.
27. To activate RF Lock Function, press SETUP Key to access Generator Menu. Press "RF lock" Soft Function Key F2. RF Lock locks RF Generator Frequency to Receiver RF Frequency and Analyzer RF Frequency. "RF lock" appears in red when active. Press "RF lock" Soft Function Key F2 to deactivate RF Lock Function.

**NOTE:** The following steps use the Frequency List (F.L.) that is shared between the RF Generator, Receiver, Duplex, Duplex Transmitter and Duplex Receiver Operation Screens. The Frequency List can be used as a list to manually select different frequencies or as a table for scanning. When used for scanning, specific frequencies in the Frequency List must be manually toggled On or Off.

### Frequency List Mode

28. To operate RF Generator in Frequency List Mode, press SETUP Key and 5 DATA ENTRY Key (29) to display RF Generator Setup Menu. Press 3 DATA ENTRY Key (29) to display RF Generator Mode submenu. Press 4 DATA ENTRY Key (29) to select Freq List. Press "F.L." Soft Function Key F4 to display the Stored RF Frequency List.
  - Press ↑ or ↓ FIELD SELECT Keys (1), in conjunction with "Pg Up" or "Pg Dn" Soft Function Keys F1 and F2, as needed, to move cursor to desired Item line in the Frequency List.
  - Press ← or → FIELD SELECT Keys (1) as needed to move cursor to select the Generate, Receive or Offset entries (Offset frequency is equal to Generate frequency minus Receive frequency). Press ENTER Key to activate the data field and use DATA ENTRY Keypad (29) to enter desired frequency. Press ENTER Key.
  - Continue selecting Item lines and entering frequency values until desired Frequency List is created.
  - Press "Clear" Soft Function Key F3 to return the frequency entry selected by the cursor to 0.2500 MHz, the lowest frequency allowable.
  - Press "Fill" Soft Function Key F4 to copy the selected frequency entry value into all entries listed below in the same column.
  - Press "Ret" Soft Function Key F5 to return to RF Generator Operation Screen.
  - Press "More" Soft Function Key F6 until "Freq" Soft Function Key F2 appears. Press "Freq" Soft Function Key F2 to activate the data field of the Frequency List Item number. Press ↑ or ↓ DATA SCROLL Keys (3) to select desired frequency. Press ENTER Key.

### Frequency List Scan Mode

29. To operate RF Generator in Frequency List Scan Mode, press SETUP Key and 5 DATA ENTRY Key (29) to display RF Generator Setup Menu. Press 3 DATA ENTRY Key (29) to display RF Generator Mode submenu. Press 5 DATA ENTRY Key (29) to select Freq List Scan. Press "F.L." Soft Function Key F4 to display the Stored RF Frequency List.
  - Refer to Step 28, Frequency List Mode, to create the desired listing of frequencies.
  - Use the FIELD SELECT Keys (1) and the ENTER Key to toggle the Scan "switch" to 'on' or 'off' for each Item listing. Item listings that are turned off are skipped when the scan operation is activated.
  - Press "Ret" Soft Function Key F5 to return to RF Generator Operation Screen.

**STEP****PROCEDURE**

---

- Press GO TEST CONTROL Key (28) to start RF Generator Scan. Press STOP TEST CONTROL Key (28) to stop Scanning. Pressing GO TEST CONTROL Key (28) again resumes scanning operation. Press SGL STEP TEST CONTROL Key (28) to single step through scanning operation one increment at a time.
- While scanning or single stepping through the Frequency List, the operation begins again at the first "turned-on" frequency listing after reaching the last frequency listing.

**NOTE:** To store or recall a set of screen parameters, see 4-1-1.

## 4-2-2 GENERATING FM MODULATED RF SIGNAL

**EXAMPLE:** The following example generates a 90 MHz signal FM modulated with a 1 kHz sine wave. The modulation level is 4 kHz and the RF Output Level is -60 dBm.

STEP	PROCEDURE
1.	Move cursor to RF (40) and press 9 and 0 DATA ENTRY Keys (29) to set RF Generator Frequency to <b>90.0000 MHz</b> . Press ENTER Key.
2.	Press SETUP Key and 5 DATA ENTRY Key (29) to display RF Generator Setup Menu. Press 4 DATA ENTRY Key (29) until <b>dBm</b> is selected for RF Gen Level Units. Press "Ret" Soft Function Key F5.
3.	Move cursor to LEVEL (44) and press +/-, 6 and 0 DATA ENTRY Keys (29) to set RF Generator Level to <b>-60.0 dBm</b> . Press ENTER Key.
4.	Move cursor to SOURCE (30) and press ENTER Key. Use DATA SCROLL ← and → Keys (3) to select AF Generator <b>1</b> . Use DATA SCROLL ↑ and ↓ Keys (3) to select <b>FM</b> and press ENTER Key.
5.	Move cursor to DEVIATION (33) and press 4 DATA ENTRY Key (29) to set Deviation to <b>4.0 kHz</b> . Press ENTER Key.
6.	Move cursor to AF FREQ (35) and press 1, 0, 0 and 0 DATA ENTRY Keys (29) to set AF Frequency to <b>1000.0 Hz</b> . Press ENTER Key.
7.	Move cursor to WAVE (37) and press DATA SCROLL ↑ and ↓ Keys (3) until <b>Sine</b> appears and press ENTER Key.

## 4-2-3 GENERATING AM MODULATED RF SIGNAL

**EXAMPLE:** The following example generates an 850 kHz signal AM modulated with a 2 kHz sine wave. The modulation level is 25% and RF Output Level is 0.224 mV.

STEP	PROCEDURE
1.	Move cursor to RF (40) and press •, 8 and 5 DATA ENTRY Keys (29) to set RF Generator Frequency to <b>0.8500 MHz</b> . Press ENTER Key.
2.	Press SETUP Key and 5 DATA ENTRY Key (29) to display RF Generator Setup Menu. Press 4 DATA ENTRY Key (29) until <b>Volts</b> is selected for RF Gen Level Units. Press "Ret" Soft Function Key F5 to return to RF Generator Operation Screen.
3.	Move cursor to LEVEL (44) and press ENTER Key. Press •, 2, 2, 4 and k/m DATA ENTRY Keys (29) to set RF Generator Level to <b>0.224 mV</b> .
4.	Move cursor to SOURCE (30) and press ENTER Key. Use DATA SCROLL ← and → Keys (3) to select AF Generator <b>1</b> . Use DATA SCROLL ↑ and ↓ Keys (3) to select <b>AM</b> and press ENTER Key.
5.	Move cursor to MODULATION (33) and press 2 and 5 DATA ENTRY Keys (29) to set Modulation to <b>25%</b> . Press ENTER Key.

## STEP

## PROCEDURE

6. Move cursor to AF FREQ (35) and press 2, 0, 0 and 0 DATA ENTRY Keys (29) to set AF Frequency to **2000.0 Hz**. Press ENTER Key.
7. Move cursor to WAVE (37) and press DATA SCROLL ↑ and ↓ Keys (3) until "**Sine**" appears, and press ENTER Key.

## 4-2-4 EXTERNALLY MODULATING RF SIGNAL GENERATOR

**EXAMPLE:** The following example generates a 450 MHz signal FM modulated with an external signal applied to EXT MOD IN Connector (17). The modulation level is 4 kHz and RF Output Level is -65 dBm.

## STEP

## PROCEDURE

1. Move cursor to RF (40) and press 4, 5 and 0 DATA ENTRY Keys (29) to set RF Generator Frequency to **450.0000 MHz**. Press ENTER Key.
2. Press SETUP Key and 5 DATA ENTRY Key (29) to display RF Generator Setup Menu. Press 4 DATA ENTRY Key (29) until **dBm** is selected for RF Gen Level Units. Press "Ret" Soft Function Key F5 to return to RF Generator Operation Screen.
3. Move cursor to LEVEL (44) and press +/-, 6 and 5 DATA ENTRY Keys (29) to set RF Generator Level to **-65.0 dBm**. Press ENTER Key.
4. Move cursor to SOURCE (30) and press ENTER Key. Use DATA SCROLL ← and → Keys (3) to select **EXT**. Use DATA SCROLL ↑ and ↓ Keys (3) to select **FM** and press ENTER Key.
5. Move cursor to DEVIATION (33) and press 4 DATA ENTRY Key (29) to set Deviation to **4.0 kHz**. Press ENTER Key. Deviation setting assumes EXT MOD IN Connector (17) input is 3.54 VRMS. Deviation settings are set higher for lower EXT MOD IN Connector (17) input voltages to achieve same deviation level as per following equation:

$$\begin{array}{rcccl} \text{Modulation} & & \text{EXT MOD IN} & & \text{Actual} \\ \text{Level setting} & \times & \text{Connector} & + & \text{Modulation} \\ \text{(kHz, \%, rad)} & & \text{Input (VRMS)} & & \text{Level} \\ & & & & + 3.54 = \end{array}$$

6. Apply external modulated signal to EXT MOD IN Connector (17).



## 4-2-5 GENERATING DTMF CODED RF SIGNAL

**EXAMPLE:** The following example generates a 450 MHz signal FM modulated with a DTMF Code. The modulation level is 4 kHz and RF Output Level is -60 dBm.

STEP	PROCEDURE
1.	Move cursor to RF (40) and press 4, 5 and 0 DATA ENTRY Keys (29) to set RF Generator Frequency to <b>450.0000 MHz</b> . Press ENTER Key.
2.	If LEVEL units are volts, press SETUP Key and 5 DATA ENTRY Key (29) to display RF Generator Setup Menu. Press 4 DATA ENTRY Key (29) until <b>dBm</b> is selected for RF Gen Level Units. Press "Ret" Soft Function Key F5 to return to RF Generator Operation Screen.
3.	Move cursor to LEVEL (44) and press +/-, 6 and 0 DATA ENTRY Keys (29) to set RF Generator Level to <b>-60.0 dBm</b> . Press ENTER Key.
4.	Move cursor to SOURCE (30) and press ENTER Key. Use DATA SCROLL ← and → Keys (3) to select Source <b>3</b> . Use DATA SCROLL ↑ and ↓ Keys (3) to select <b>FM</b> and press ENTER Key.
5.	Move cursor to DEVIATION (33) and press 4 DATA ENTRY Key (29) to set Deviation to <b>4.0 kHz</b> . Press ENTER Key.
6.	Press SETUP Key to access RF Generator Menu and press 3 DATA ENTRY Key (29). Press 1 DATA ENTRY Key (29) and DTMF Format Menu appears.
7.	Select Id of Sequence to be entered using FIELD SELECT Keys (1) and press ENTER Key.
8.	Move cursor to Timing column and use DATA SCROLL ↑ and ↓ Keys (3) to select Std (standard) or User. If User is chosen, data fields appear for Mark Timing and Space Timing. Use DATA ENTRY Keypad (29) to enter timing desired and press ENTER Key.
9.	Move cursor to Selection column and enter a sequence using DATA ENTRY Keypad (29) and press ENTER Key. <b>NOTE:</b> Pressing SHIFT Key toggles DATA ENTRY Keypad (29) between numeric and alphabetic characters.
10.	Move cursor to Mod column and use DATA SCROLL ↑ and ↓ Keys (3) to select modulation. Move cursor to percent modulation and select using DATA ENTRY Keypad (29).
11.	Press ENTER Key and "Ret" Soft Function Key to return to RF Generator Operation Screen.
12.	Move cursor to DIRECT ENTRY/PROGRAM # (47) and press ENTER Key until <b>PROGRAM #</b> appears.
13.	Move cursor to Program Number (48) and use DATA ENTRY Keypad (29) to select a programmed Id.
14.	Press GO TEST CONTROL Key (28) to generate DTMF sequence continually. Press STOP TEST CONTROL Key (28) to stop DTMF sequence. Press STOP TEST CONTROL Key (28) to stop sequence. Press SGL STEP TEST CONTROL Key (28) to generate sequence once.

## 4-2-6 GENERATING AUDIO TWO TONE CODING

**EXAMPLE:** The following example generates a 150 MHz signal FM modulated with an Audio Two Tone Code. The modulation level is 4 kHz and RF Output Level is 0 dBm.

STEP	PROCEDURE
1.	Move cursor to RF (40) and press 1, 5 and 0 DATA ENTRY Keys (29) to set RF Generator Frequency to <b>150.0000 MHz</b> . Press ENTER Key.
2.	If LEVEL units are volts, press SETUP Key and 5 DATA ENTRY Key to display RF Generator Setup Menu. Press 4 DATA ENTRY Key (29) until <b>dBm</b> appears. Press "Ret" Soft Function Key F5 to return to RF Generator Operation Screen.
3.	Move cursor to LEVEL (44) and press 0 DATA ENTRY Key (29) to set RF Generator Level to <b>0.0 dBm</b> . Press ENTER Key.
4.	Move cursor to SOURCE (30) and press ENTER Key. Use DATA SCROLL ← and → Keys (3) to select Source <b>3</b> . Use DATA SCROLL ↑ and ↓ Keys (3) to select <b>FM</b> and press ENTER Key.
5.	Move cursor to DEVIATION (33) and press 4 DATA ENTRY Key (29) to set Deviation to <b>4.0 kHz</b> . Press ENTER Key.
6.	Press SETUP Key to access RF Generator Menu and press 3 DATA ENTRY Key (29). Press 2 DATA ENTRY Key (29) and Audio Signaling Format Menu appears.
7.	Move cursor to "12. User Defined" and press ENTER Key. Press 2 DATA ENTRY Key (29) to access Define Tones Menu.
8.	Move cursor to Tone(Hz) location in 0 row. Press 0 DATA ENTRY (29) Keys and press ENTER Key. Press FIELD SELECT → Key (1) to move cursor to Duration(ms) column. Press 1, 0 and 0 DATA ENTRY Keys (29) and press ENTER Key.
9.	Move cursor to Tone(Hz) location in 1 row. Press 8, 8 and 0 DATA ENTRY Keys (29) and press ENTER Key. Press FIELD SELECT → Key (1) to move cursor to Duration(ms) column. Press 5, 0 and 0 DATA ENTRY Keys (29) and press ENTER Key.
10.	Move cursor to Tone(Hz) location in 2 row. Press 2, 2, 0 and 0 DATA ENTRY (29) Keys and press ENTER Key. Press FIELD SELECT → Key (1) to move cursor to Duration(ms) column. Press 5, 0 and 0 DATA ENTRY Keys (29) and press ENTER Key.
11.	Press "ESC" Soft Function Key F6 and press 1 DATA ENTRY Key (29) to display Define Sequence Menu. Move cursor to 1 in Id column and press ENTER Key. Press 1, 0 and 2 DATA ENTRY Keys (29) and press ENTER Key. Press "Ret" Soft Function Key F5 to return to RF Generator Operating Screen.
12.	Move cursor to PROG #/DIRECT ENTRY (47) and press ENTER Key until <b>PROG #</b> appears.
13.	Move cursor to Program Number (48), press 1 DATA ENTRY Key (29) to select programmed sequence number <b>1</b> and press ENTER Key.
14.	Press GO TEST CONTROL Key (28) to generate sequence continually. Press STOP TEST CONTROL Key (28) to stop sequence. Press SGL STEP TEST CONTROL Key (28) to generate sequence once.

## 4-2-7 GENERATING 5/6 AUDIO TONE

**EXAMPLE:** The following example generates a 162 MHz signal FM modulated with an Audio 5/6 Tone Code. The modulation level is 4 kHz and RF Output Level is 0 dBm.

STEP	PROCEDURE
1.	Move cursor to RF (40) and press 1, 6 and 2 DATA ENTRY Keys (29) to set RF Generator Frequency to <b>162.0000 MHz</b> . Press ENTER Key.
2.	If LEVEL units are volts, press SETUP Key and 5 DATA ENTRY Key (29) to display RF Generator Setup Menu. Press 4 DATA ENTRY Key (29) until <b>dBm</b> is selected for RF Gen Level Units. Press "Ret" Soft Function Key F5 to return to RF Generator Operation Screen.
3.	Move cursor to LEVEL (44) and press 0 DATA ENTRY Keys (29) to set RF Generator Level to <b>0.0 dBm</b> . Press ENTER Key.
4.	Move cursor to SOURCE (30) and press ENTER Key. Use DATA SCROLL ← and → Keys (3) to select Source <b>3</b> . Use DATA SCROLL ↑ and ↓ Keys (3) to select <b>FM</b> and press ENTER Key.
5.	Move cursor to DEVIATION (33) and press 4 DATA ENTRY Key (29) to set Deviation to <b>4.0 kHz</b> . Press ENTER Key.
6.	Press SETUP Key to access RF Generator Menu and press 3 DATA ENTRY Key (29). Press 2 DATA ENTRY Key (29) and Audio Signaling Format Menu appears.
7.	Move cursor to "12. User Defined" and press ENTER Key. Press 2 DATA ENTRY Key (29) to access Define Tones Menu.
8.	Move cursor to Tone(Hz) location in 0 row. Press 9, 0 and 0 DATA ENTRY (29) Keys and press ENTER Key. Press FIELD SELECT → Key (1) to move cursor to Duration(ms) column. Press 1, 5 and 0 DATA ENTRY Keys (29) and press ENTER Key.
9.	Move cursor to Tone(Hz) location in 1 row. Press 1, 1, 0 and 0 DATA ENTRY Keys (29) and press ENTER Key. Press FIELD SELECT → Key (1) to move cursor to Duration(ms) column. Press 8 and 0 DATA ENTRY Keys (29) and press ENTER Key.
10.	Move cursor to Tone(Hz) location in 2 row. Press 1, 2, 0 and 0 DATA ENTRY (29) Keys and press ENTER Key. Press FIELD SELECT → Key (1) to move cursor to Duration(ms) column. Press 8 and 0 DATA ENTRY Keys (29) and press ENTER Key.
11.	Move cursor to Tone(Hz) location in 3 row. Press 1, 3, 0 and 0 DATA ENTRY Keys (29) and press ENTER Key. Press FIELD SELECT → Key (1) to move cursor to Duration(ms) column. Press 8 and 0 DATA ENTRY Keys (29) and press ENTER Key.
12.	Move cursor to Tone(Hz) location in 4 row. Press 1, 4, 0 and 0 DATA ENTRY Keys (29) and press ENTER Key. Press FIELD SELECT → Key (1) to move cursor to Duration(ms) column. Press 8 and 0 DATA ENTRY Keys (29) and press ENTER Key.
13.	Move cursor to Tone(Hz) location in A row. Press 0 DATA ENTRY Key (29) and press ENTER Key. Press FIELD SELECT → Key (1) to move cursor to Duration(ms) column. Press 4 and 0 DATA ENTRY Keys (29) and press ENTER Key.

STEP	PROCEDURE
14.	Press "ESC" Soft Function Key F6 and press 1 DATA ENTRY Key (29) to display Define Sequence Menu. Move cursor to 2 in Id column and press ENTER Key. Press 0 DATA ENTRY Key, press SHIFT Key, press "A" DATA ENTRY Key (29), press SHIFT Key and press 1, 2, 3 and 4 DATA ENTRY Keys (29). Press ENTER Key. Press "Ret" Soft Function Key F5 to return to RF Generator Operating Screen.
15.	Move cursor to PROG #/DIRECT ENTRY (47) and press ENTER Key until <b>PROG #</b> appears.
16.	Move cursor to Program Number (48) and press 1 DATA ENTRY Key (29) to select programmed sequence number <b>1</b> . Press ENTER Key.
17.	Press GO TEST CONTROL Key (28) to generate sequence continually. Press STOP TEST CONTROL Key (28) to stop sequence. Press SGL STEP TEST CONTROL Key (28) to generate sequence once.

#### 4-2-8 GENERATING DCS CODE

**EXAMPLE:** The following example generates a 162.4500 MHz signal FM modulated with a DCS Code. The modulation level is 1 kHz and RF Output Level is 0 dBm.

STEP	PROCEDURE
1.	Move cursor to RF (40) and press 1, 6, 2, <b>.</b> , 4 and 5 DATA ENTRY Keys (29) to set RF Generator Frequency to <b>162.4500 MHz</b> . Press ENTER Key.
2.	If LEVEL units are volts, press SETUP Key and 5 DATA ENTRY Key (29) to display RF Generator Setup Menu. Press 4 DATA ENTRY Key (29) until <b>dBm</b> is selected for RF Gen Level Units. Press "Ret" Soft Function Key F5 to return to RF Generator Operation Screen.
3.	Move cursor to LEVEL (44) and press 0 DATA ENTRY Keys (29) to set RF Generator Level to <b>0.0 dBm</b> . Press ENTER Key.
4.	Move cursor to SOURCE (30) and press ENTER Key. Use DATA SCROLL ← and → Keys (3) to select Source <b>3</b> . Use DATA SCROLL ↑ and ↓ Keys (3) to select <b>FM</b> and press ENTER Key.
5.	Move cursor to DEVIATION (33) and press 1 DATA ENTRY Key (29) to set Deviation to <b>1.0 kHz</b> . Press ENTER Key.
6.	Press SETUP Key to access RF Generator Menu and press 3 DATA ENTRY Key (29). Press 3 DATA ENTRY Key (29) and Digital Menu appears. Press "Ret" Soft Function Key F5 to return to RF Generator Operation Screen.
7.	Move cursor to Signaling Code (46) and press DATA SCROLL ↑ and ↓ Keys (3) until <b>DCS</b> appears. Press ENTER Key.
8.	Move cursor to PROG #/DIRECT ENTRY (47) and press ENTER Key until <b>DIRECT ENTRY</b> appears.

## STEP

## PROCEDURE

9. Move cursor to Sequence (50) and press 4, 6 and 5 DATA ENTRY Keys (29). Press ENTER Key.
10. Press GO TEST CONTROL Key (28) to generate sequence continually. Press STOP TEST CONTROL Key (28) to stop sequence. Press SGL STEP TEST CONTROL Key (28) to generate sequence once.

## 4-2-9 GENERATING POCSAG CODE

**EXAMPLE:** The following example generates a 930 MHz signal FM modulated with a POCSAG Code. The modulation level is 4 kHz and RF Output Level is 0 dBm.

## STEP

## PROCEDURE

1. Move cursor to RF (40) and press 9, 3 and 0 DATA ENTRY Keys (29) to set RF Generator Frequency to **930.0000 MHz**. Press ENTER Key.
2. If LEVEL units are volts, press SETUP Key and 5 DATA ENTRY Key (29) to display RF Generator Setup Menu. Press 4 DATA ENTRY Key (29) until **dBm** is selected for RF Gen Level Units. Press "Ret" Soft Function Key F5 to return to RF Generator Operation Screen.
3. Move cursor to LEVEL (44) and press 0 DATA ENTRY Key (29) to set RF Generator Level to **0.0 dBm**. Press ENTER Key.
4. Move cursor to SOURCE (30) and press ENTER Key. Use DATA SCROLL ← and → Keys (3) to select Source **3**. Use DATA SCROLL ↑ and ↓ Keys (3) to select **FM** and press ENTER Key.
5. Move cursor to DEVIATION (33) and press 4 DATA ENTRY Key (29) to set Deviation to **4.0 kHz**. Press ENTER Key.
6. Press SETUP Key to access RF Generator Menu and press 3 DATA ENTRY Key (29). Press 3 DATA ENTRY Key (29) and Digital Menu appears. Press 3 DATA ENTRY Key (29) to display POCSAG Menu.
7. Press 1 DATA ENTRY Key and press 5, 1, 3 and 0 DATA ENTRY Keys (29) to set Capcode 1 to **5130**. Press ENTER Key. Press 2 DATA ENTRY Key (29) and press 5, 1, 3 and 5 DATA ENTRY Keys (29) to set Capcode 2 to **5135**. Press ENTER Key.
8. Press 3 DATA ENTRY Key (29) until **512 Baud** appears as the Transmit rate. Press 4 and 9 DATA ENTRY Keys (29) to select **Alphanumeric** as message type.
9. Press "Ret" Soft Function Key F5 to return to RF Generator Operation Screen.
10. Press GO TEST CONTROL Key (28) to generate POCSAG Code. Capcode being generated appears below message type (49). When all capcodes specified are generated, Complete appears. Press SGL STEP TEST CONTROL Key (28) to generate one capcode and pause. Press STOP TEST CONTROL Key (28) to stop generating Code.

## 4-2-10 GENERATING 2805 CODE

**EXAMPLE:** The following example generates a 155 MHz signal FM modulated with a 2805 Tone (with frequency reset to 1500 Hz). The modulation level is 4 kHz and RF Output Level is -60 dBm.

STEP	PROCEDURE
1.	Move cursor to RF (40) and press 1, 5 and 5 DATA ENTRY Keys (29) to set RF Generator Frequency to <b>155.0000 MHz</b> . Press ENTER Key.
2.	If LEVEL units are volts, press SETUP Key and 5 DATA ENTRY Key (29) to display RF Generator Menu. Press 4 DATA ENTRY Key (29) until <b>dBm</b> is selected for RF Gen Level Units. Press "Ret" Soft Function Key F5 to return to RF Generator Operation Screen.
3.	Move cursor to LEVEL (44) and press +/-, 6 and 0 DATA ENTRY Keys (29) to set RF Generator Level to <b>-60 dBm</b> . Press ENTER Key.
4.	Move cursor to SOURCE (30) and press ENTER Key. Use DATA SCROLL ← and → Keys (3) to select Source <b>3</b> . Use DATA SCROLL ↑ and ↓ Keys (3) to select <b>FM</b> and press ENTER Key.
5.	Move cursor to DEVIATION (33) and press 4 DATA ENTRY Key (29) to set Deviation to <b>4.0 kHz</b> . Press ENTER Key.
6.	Press SETUP Key to access RF Generator Menu and press 3 DATA ENTRY Key (29). Press 4 DATA ENTRY Key (29) and RCC Menu appears. Press 3 DATA ENTRY Key (29) to display 2805 Menu.
7.	Press "Tone" Soft Function Key F3 to display 2805 Frequency data field. Press 1, 5, 0 and 0 DATA ENTRY Key (29) to set 2805 frequency to <b>1500.0 Hz</b> . Press ENTER Key.
8.	Move cursor to 1 Id (Identification Number) and press ENTER Key. Press 5, 5, 5, 1, 2, 3 and 4 DATA ENTRY Keys (29) and press ENTER Key.
9.	Press "Ret" Soft Function Key F5 to return to RF Generator Operation Screen.
10.	Move cursor to PROG #/DIRECT ENTRY (47) and press ENTER Key until <b>PROG #</b> appears.
11.	Move cursor to Program Number (48) and press 1 DATA ENTRY Key (29) to select programmed sequence number <b>1</b> . Press ENTER Key.
12.	Press GO TEST CONTROL Key (28) to generate sequence continually. Press STOP TEST CONTROL Key (28) to stop sequence. Press SGL STEP TEST CONTROL Key (28) to generate sequence once.

## 4-2-11 GENERATING TONE REMOTE CODE

**EXAMPLE:** The following example generates a Tone Remote Code routed to the AUDIO OUT Connector (14) with a High Level Guard Tone at 10 dB.

STEP	PROCEDURE
1.	If LEVEL units are volts, press SETUP Key and 5 DATA ENTRY Key (29) to display RF Generator Setup Menu. Press 4 DATA ENTRY Key (29) until <b>dBm</b> is selected for RF Gen Level Units. Press "Ret" Soft Function Key F5 to return to RF Generator Operation Screen.
2.	Move cursor to LEVEL (44) and press +/-, 1, 2 and 0 DATA ENTRY Keys (29) to set RF Generator Level to <b>-120 dBm</b> . Press ENTER Key.
4.	Move cursor to SOURCE (30) and press ENTER Key. Use DATA SCROLL ← and → Keys (3) to select Source <b>3</b> . Use DATA SCROLL ↑ and ↓ Keys (3) to select <b>FM</b> and press ENTER Key.
5.	Press SETUP Key to access RF Generator Menu and press 3 DATA ENTRY Key (29). Press 4 DATA ENTRY Key (29) and RCC Code Menu appears. Press 4 DATA ENTRY Key (29) to display Tone Remote Function Menu.
6.	Use DATA ENTRY Keypad (29) to select a Tone Remote Function. Press "ESC" Soft Function Key F6 twice.
7.	Press 5 DATA ENTRY Key (29) to display RF Generator Setup Menu. Press 5 DATA ENTRY Key (29) to toggle "Source to Audio Out" until <b>On</b> appears.
8.	Press "Ret" Soft Function Key F5 to return to RF Generator Operation Screen.
9.	Connect a power meter to AUDIO OUT Connector (14). Move cursor to DEVIATION (33) and rotate DATA SCROLL Spinner (2) until AUDIO OUT Connector (14) Output measures 10 dB (approximately 6.1 kHz). Press ENTER Key and disconnect external power meter.
10.	Press GO TEST CONTROL Key (28) to generate sequence. Press STOP TEST CONTROL Key (28) to stop sequence.

## 4-2-12 MEASURING SINAD SENSITIVITY, CENTER FREQUENCY AND MODULATION ACCEPTANCE BANDWIDTH

STEP	PROCEDURE
1.	Connect T/R Connector (6) to UUT Antenna. Connect SINAD/BER IN Connector (15) to Speaker Audio Out of UUT.
2.	Adjust UUT output to 60% of rated power.
3.	Press RF GEN MODE Key (27).
4.	Press "More" Soft Function Key until "Meters" is shown for Soft Function Key F4. Press "Meters" Soft Function Key F4 and press 1 DATA ENTRY Key (29) to select SINAD Meter.
5.	Move cursor to Source (30) and press ENTER Key. Use FIELD SELECT Keys (1) to select Source <b>1</b> and press DATA SCROLL ↑ and ↓ Keys (3) to select <b>FM</b> Modulation. Press ENTER Key.
6.	Move cursor to DEVIATION (33) and press 3 DATA ENTRY Key (29) to set Deviation to <b>3.0 kHz</b> . Press ENTER Key.
7.	Move cursor to AF FREQ (35) and press 1, 0, 0 and 0 DATA ENTRY Keys (29) to set AF Frequency to <b>1000.0 kHz</b> . Press ENTER Key.
8.	Move cursor to WAVE (37) and press DATA SCROLL ↑ and ↓ Keys (3) until <b>Sine</b> appears in data field. Press ENTER Key.
9.	Move cursor to SINAD Callout and press ENTER Key. <ul style="list-style-type: none"><li>● Move cursor to NOTCH FREQ and press ENTER Key. Press 1, 0, 0 and 0 DATA ENTRY Keys (29) to set Notch Freq to <b>1000 Hz</b> and press ENTER Key.</li><li>● Move cursor to AVERAGE and press ENTER Key until <b>On</b> appears.</li><li>● If red PH is displayed at left end of Meter Indicator Bar (Peak Hold on), press Soft Function Key F5 to toggle Peak Hold off.</li><li>● Press Soft Function Key F6 to return to RF Generator Operation Screen.</li></ul>
10.	Move cursor to RF (40) and press ENTER Key. Use DATA ENTRY Keypad (29) to set RF Frequency to approximately UUT Receiving Frequency and press ENTER Key.
11.	Move cursor to LEVEL (44) and press ENTER Key. Use DATA SCROLL ↑ and ↓ Keys (3) to adjust RF Out Level until SINAD Meter reads 12 dB. Use FIELD SELECT Keys (1) to move cursor to RF (40) and press ENTER Key. Adjust RF Frequency using DATA SCROLL ↑ and ↓ Keys (3) until a maximum reading is attained on SINAD Meter. RF Frequency shows UUT Receiver's Center Frequency.



STEP

PROCEDURE

---

12. Leaving RF Frequency at UUT Receiver's Center Frequency, move cursor to LEVEL (44) and press ENTER Key. Use DATA SCROLL ↑ and ↓ Keys (3) to adjust RF Out Level until SINAD Meter reads 12 dB. RF Out Level reads UUT Receiver Sensitivity.
13. Use DATA SCROLL ↑ and ↓ Keys (3) to increase RF Out Level 6 dB and press ENTER Key.
14. Use FIELD SELECT Keys (1) to move cursor to DEVIATION (33) and press ENTER Key. Use DATA SCROLL Keys (3) to increase Deviation until SINAD Meter again reads 12 dB. Modulation Acceptance Bandwidth is twice Deviation reading.

Example: If Deviation reads 5 kHz, then Modulation Acceptance Bandwidth is 10 kHz.

## 4-2-13 MEASURING RECEIVER IF BANDWIDTH

STEP	PROCEDURE
1.	Connect UUT Antenna to T/R Connector (6). Connect Audio Out Connector (14) of receiver under test to SINAD/BER Connector of IFR-1900.
2.	Open squelch fully on receiver under test.
3.	Press RF GEN MODE Key (27) and move cursor to RF (40). Use DATA ENTRY Keys (29) to set frequency to frequency of receiver under test.
4.	Move cursor to SOURCE (30) and press ENTER Key. Use FIELD SELECT ← and → Keys (1) to select Source <b>1</b> and use DATA SCROLL ↑ and ↓ Keys (3) to select <b>FM</b> Modulation. Press ENTER Key.
5.	Move cursor to DEVIATION (33) and press 1 DATA ENTRY Key (29) to set Deviation to <b>1.0 kHz</b> . Press ENTER Key.
6.	Move cursor to AF FREQ (35) and press 1, 0, 0 and 0 DATA ENTRY Keys (29) to set AF Frequency to <b>1000.0 Hz</b> . Press ENTER Key.
7.	Move cursor to WAVE (37) and use DATA SCROLL ↑ and ↓ Keys (3) until <b>Sine</b> appears. Press ENTER Key.
8.	Press "More" Soft Function Key F6 until "Meters" Soft Function Key F4 appears. Press "Meters" Soft Function Key F4 and press 1 DATA ENTRY Key (29) to select SINAD Meter.
9.	If LEVEL (45) units are V or mV, press SETUP Key and press 5 DATA ENTRY Key (29) to display RF Generator Menu. Press 4 DATA ENTRY Key (29) to toggle RF Gen Level Units until <b>dBm</b> appears and press "Ret" Soft Function Key F5 to return to RF Gen Operation Screen.
10.	Move cursor to LEVEL (45) and use DATA SCROLL ↑ and ↓ Keys (3) to adjust Output Level until SINAD Meter reads 12 dB. Resulting Output Level is Reference Sensitivity.
11.	Use DATA SCROLL ↑ and ↓ Keys (3) to adjust Output Level 60 dBm above Reference Sensitivity measured in Step 10.
12.	Move cursor to RF (40) and press ENTER Key. Press DATA SCROLL → Key (3) until least significant digit is highlighted. Press DATA SCROLL ↑ Key (3) until SINAD Meter reads 12 dB. RF reads Upper Frequency.
13.	Press DATA SCROLL ↓ Key (3) until SINAD Meter reads 12 dB. RF reads Lower Frequency. The difference between Upper Frequency and Lower Frequency is 60 dB skirt width.

## 4-3 RECEIVER OPERATION

### 4-3-1 RECEIVER GENERAL OPERATION

Low power (-65 to 0 dBm) RF signals are monitored "off the air" from ANTENNA IN Connector (25). High power RF signals (-5 to +47 dBm) are monitored through T/R Connector (6) using the following procedures:

**NOTE:** Except for the Signal Strength Meter, valid Receiver Operation Screen meter readings are not displayed until Squelch is broken

RECEIVE SCREEN WITH SQUELCH UNBROKEN

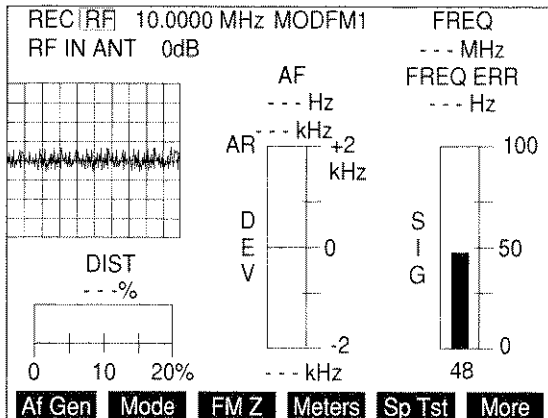

03416123

RECEIVE SCREEN WITH SQUELCH BROKEN

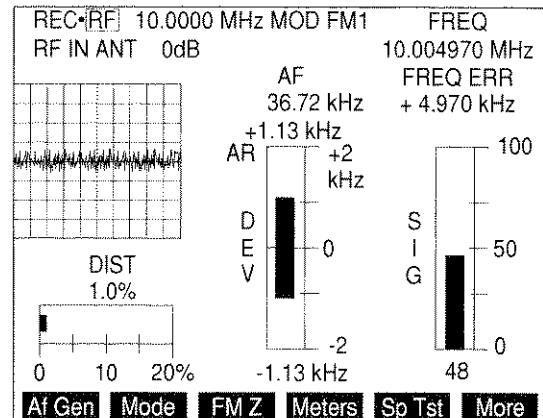

03416124

#### STEP

#### PROCEDURE

1. Install right angle BNC adapter and antenna to ANTENNA IN Connector (25) for antenna input or connect RF signal input to T/R Connector (6).

**CAUTION:** MAXIMUM CONTINUOUS INPUT TO ANTENNA IN CONNECTOR (25) IS LIMITED TO 10 W. MAXIMUM CONTINUOUS INPUT TO T/R CONNECTOR (6) IS LIMITED TO 50 W.

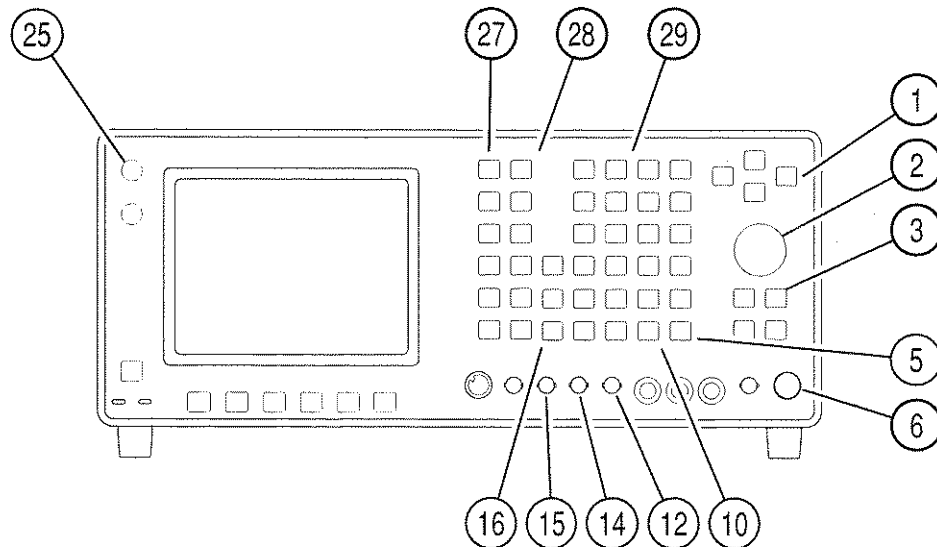

03407010

2. Press RCVR MODE Key (27). Receiver Operation Screen appears:

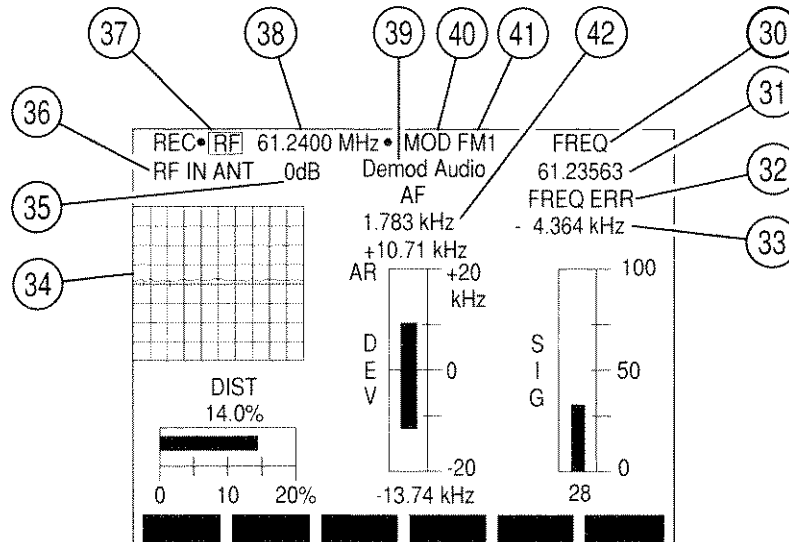

8607059

- Move cursor to RF IN data field (36) and press ENTER Key to toggle RF Input location between "ANT" and "T/R" to match input location of received signal.
- Move cursor to RF (37) and press ENTER Key to access frequency data field (38). Use DATA ENTRY Keypad (29) to enter a frequency (in MHz) and press ENTER Key.
 

**NOTE:** RF Frequency Error Meter gives inaccurate results when Deviation Meter readings exceed Deviation Meter Range.
- To adjust squelch level, press a SQLCH Key (10). Squelch data field appears. Press SQLCH Keys (10) to adjust Squelch and press ENTER Key.
- To adjust volume, press a VOL Key (5). Volume data field appears. Press VOL Keys (5) to adjust Volume and press ENTER Key.
- Move cursor to Input Attenuation Level (35) and press ENTER Key to access data field. Press DATA SCROLL  $\uparrow$  or  $\downarrow$  Keys (3) until desired selection appears in data field and press ENTER Key to activate input attenuation.
- Move cursor to MOD (40) and press ENTER Key to access Modulation Type data field (41). Use DATA SCROLL  $\uparrow$  or  $\downarrow$  Keys (3) until desired setting appears in data field and press ENTER Key to activate. See Table 3-2 for description of modulation types.
- If User is selected as Modulation Type, press SETUP Key to access Receiver Menu. Press 2 DATA ENTRY Key (29) to display Receiver Modulation Menu and press ENTER Key. User Defined Modulation Menu appears:

Rcvr Menu	
1.	Set Rcvr Freq 200.0000 MHz
2.	Select Mod User Defined
3.	
4.	1. Modulation FM DATA
5.	2. IF Filters 3 KHz
6.	3. Post Detection All Pass
7.	Rcvr Out Audio Out Off
8.	Rcvr Out Demod Out On
9.	Auto Volume Level Off
10.	Operation Mode Freq Scan
11.	Signaling Formats DTMF
Scan RF lock F.L. Ret ESC	

8610347

- Press 1 DATA ENTRY Key (29) and use DATA ENTRY Keypad (29) to select User Modulation Type.
  - Press 2 DATA ENTRY Key (29) and use DATA ENTRY Keypad (29) to select an IF Filter.
  - Press 3 DATA ENTRY Key (29) and use DATA ENTRY Keypad (29) to select a Post Detection Filter. If Low Pass, High Pass or Band Pass is selected, a cutoff frequency data field appears. Use DATA ENTRY Keypad (29) to enter cutoff frequencies and press ENTER Key.
  - Press "Ret" Soft Function Key F5 to return to Receiver Operation Screen.
10. If decoding Signaling Formats is not desired, proceed with Step 18.
11. Press SETUP Key to display Receiver Menu, move cursor to "11. Signaling Formats" and press ENTER Key. Use DATA ENTRY Keypad (29) to select a Signaling Format.
- If DTMF is selected, press "Ret" Soft Function Key F5 to return to Receiver Operation Screen.
  - If Audio is selected, Audio Code Menu appears. Use FIELD SELECT Keys (1) to select an Audio Code and press ENTER Key. If User is selected, menu used to define the desired tones appears:

Rcvr Menu	
1.	S 1. CCIR
2.	S 2. EEA
3.	S 3. U.S. (EIA)
4.	S 4. Id Tone(Hz) Duration(ms)
5.	S 5. 0 5.0 20
6.	R 6. 1 10.0 20
7.	R 7. 2 20.0 20
8.	R 8. 3 30.0 20
9.	A 9. 4 40.0 20
10.	O 10. 5 50.0 20
11.	S 11. 6 60.0 20
	12. 7 70.0 20
Scan RF lock Fill Ret ESC	

8617111

Move cursor to tone and duration of each Id character used. Use DATA ENTRY Keypad (29) to enter values and press ENTER Key. When desired tones are defined, press "ESC" Soft Function Key F6. Press "Ret" Soft Function Key F5 to return to Receiver Operation Screen.

- If Digital is selected, Digital Code Menu appears. Use DATA ENTRY Keypad (29) to select a Digital Code. Press "Ret" Soft Function Key F5 to return to Receiver Operation Screen.

12. Press "More" Soft Function Key F6 until "Disp" Soft Function Key F1 is displayed. Press "Disp" Soft Function Key F1 to display following submenu:

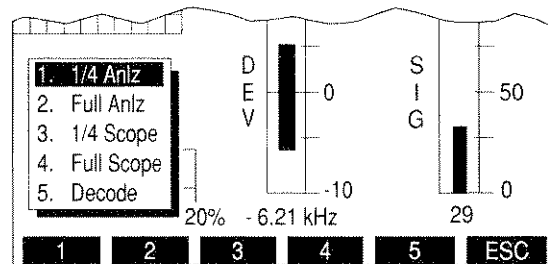

8617081

13. Press 5 DATA ENTRY Key (29) to display Decode Callout (44).

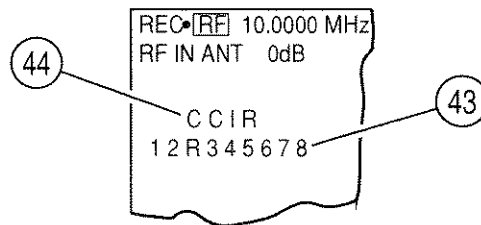

8617066

14. For DTMF Decode, press "Decode" Soft Function Key F2. Decoded digits (43) are displayed under DTMF Callout. To stop decoding, press "Stop" Soft Function Key F3.

15. For DCS or DCS INV Decode:

- To change Input Source, press "Input" Soft Function Key F5. A submenu appears listing Input Sources. Use DATA ENTRY Keypad (29) to select an Input Source.

**NOTE:** Source "2. SIN/BER (INV)" inverts Input before decoding.

- Press "Decode" Soft Function Key F2. Decoded digits (43) are displayed under Decode Callout (44). To stop decoding, press "Stop" Soft Function Key F3.

16. For Audio Decode, press "Extend" Soft Function Key F5 to display the following screen:

Audio Tones Decode: CCIR							
#	Frq	Err %	Dur	#	Frq	Err %	Dur
1	1158	3.2	98				
2	1167	2.5	99				
3	1298	1.8	101				
4	1406	3.5	98				
5	1475	2.0	98				

Input Decode Stop Type Ret

8610175

- To change Input Source, press "Input" Soft Function Key F1. A submenu appears listing Input Sources. Use DATA ENTRY Keypad (29) to select an Input Source.
  - Press "Type" Soft Function Key F4 to select Audio Code. Use DATA SCROLL ↑ and ↓ Keys (3) to select an Audio Code and press ENTER Key.
  - Press "Decode" Soft Function Key F2 to decode. Decoded digits, frequencies, frequency error percentages and time durations are displayed.
  - Press "Stop" Soft Function Key F3 to stop decoding. Press "Ret" Soft Function Key F5 to return to Receive Operation Screen.
17. For POCSAG Decode, press "Extend" Soft Function Key F5 to display the following screen:

POCSAG Decode : LOW			
Capcode :	0005130	TYPE :	NUMERIC
Msg :	316 - 555 - 4437		
Capcode :	0005140	TYPE :	NUMERIC
Msg :	316 - 555 - 9746		
Capcode :	0005145	TYPE :	NUMERIC

Input Decode Stop Rate Auto Cl Ret

8610212

- To change Input Source, press "Input" Soft Function Key F1. A submenu appears listing Input Sources. Use DATA ENTRY Keypad (29) to select an Input Source.
- Press "Rate" Soft Function Key F4 to toggle POCSAG Rate to 512 Baud or 1200 Baud.
- Press "Decode" Soft Function Key F2 to decode. POCSAG Capcode, type and message are displayed.

- To enable automatic screen clear, press "Auto Cl" Soft Function Key F5 until "Auto Cl" appears in red. When enabled, clears full screen when next POCSAG word is received.
  - Press "Stop" Soft Function Key F3 to stop decoding. Press "Ret" Soft Function Key F6 to return to Receive Operation Screen.
18. To set Receiver Output parameters, press SETUP Key to display Receiver Menu.
- Press 5 DATA ENTRY Key (29) to display AGC Type Menu. Use DATA ENTRY Keypad (29) to select an AGC Type.
    - If User Defined is selected as AGC Type, User Defined AGC Type Menu appears. Use DATA ENTRY Keypad (29) to select an User Defined AGC Type.
    - If Manual is selected, a data field appears. Use DATA ENTRY Keypad (29) to enter an AGC Level and press ENTER Key.
  - To route demodulated Received Signal to Speaker, press 6 DATA ENTRY Key (29) to toggle "Rcvr Out Speaker" on.
  - To route demodulated Received Signal to AUDIO OUT Connector (14), press 7 DATA ENTRY Key (29) to toggle "Rcvr Out Audio Out" on.
  - To route demodulated Received Signal to DEMOD OUT Connector (12), press 8 DATA ENTRY Key (29) to toggle "Rcvr Out Demod Out" on.
  - Press 9 DATA ENTRY Key (29) to toggle Automatic Volume Level on or off.
  - Press "Ret" Soft Function Key F5 to return to Receiver Operation Screen.
19. If an Oscilloscope or Analyzer Display is not desired, proceed with Step 24.
20. Press "More" Soft Function Key F6 until "Disp" Soft Function Key F1 appears. Press "Disp" Soft Function Key F1 to display a menu listing Oscilloscope and Analyzer options. Use DATA ENTRY Keypad (29) to select an option.

**NOTE:** 1/4 size Analyzer Screen parameters are edited by first selecting full size Analyzer display, changing parameters and then reselecting 1/4 size Analyzer display.



21. If "2. Full Anlz" is selected, following Soft Function Keys are displayed:

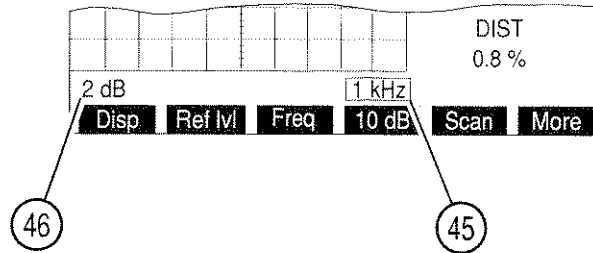

8607318

- Move cursor to Analyzer Scan Width (45) and press ENTER Key to access the data field. Press DATA SCROLL ↑ or ↓ Keys (3) until desired selection appears in data field and press ENTER Key to activate Scan Width desired.
  - Move cursor to Units/Division Factor (46) and press ENTER Key to toggle Units/Division Factor between 2 and 10 dB.
  - If 2 dB is selected for Units/Division Factor, press "Ref lvl" Soft Function Key F2 and use DATA SCROLL Spinner (2) or DATA SCROLL ↑ and ↓ Keys (3) to adjust Reference Level. Press ENTER Key.
22. If "3. 1/4 Scope" is selected, move cursor to Oscilloscope Input (39) and press ENTER Key to access the data field. Press DATA SCROLL ↑ or ↓ Keys (3) until desired selection appears in data field and press ENTER Key to activate.

**NOTE:** The remaining Oscilloscope parameters are edited by selecting full size Scope display, editing desired parameters and reselecting 1/4 size Scope display.

23. If "4. Full Scope" is selected:

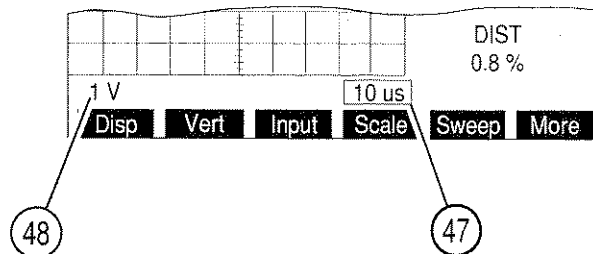

8607080

- Move cursor to Oscilloscope Input (39) and press ENTER Key to access the data field. Press DATA SCROLL ↑ or ↓ Keys (3) until desired selection appears in data field and press ENTER Key to activate.
- If needed, move cursor to Oscilloscope Sweep Rate (47) and press ENTER Key to access the data field. Press DATA SCROLL ↑ or ↓ Keys (3) until desired selection appears in data field and press ENTER Key to activate.
- Move cursor to Oscilloscope Scale (48) and press ENTER Key to access the data field. Press DATA SCROLL ↑ or ↓ Keys (3) until desired selection appears in data field and press ENTER Key to activate.

- If needed, press "Vert" Soft Function Key F2 to edit vertical adjustment of Oscilloscope Trace. Use DATA SCROLL Spinner (2) or DATA SCROLL  $\uparrow$  or  $\downarrow$  Keys (3) to adjust vertical position of Oscilloscope Trace. Press ENTER Key.
24. Press "More" Soft Function Key F6 until "Af Gen" Soft Function Key F1 appears. Press "Af Gen" Soft Function Key F1 to display the following submenu:

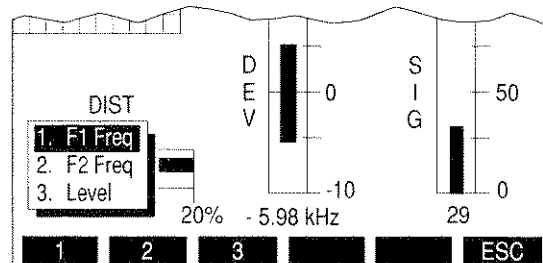

8617082

- To edit AF Generator #1 Frequency, press 1 DATA ENTRY Key. A data field appears displaying the current frequency. Use DATA ENTRY Keypad (29) to enter desired frequency and press ENTER Key.
  - To edit AF Generator #2 Frequency, press 2 DATA ENTRY Key (29). A data field appears displaying current frequency. Use DATA ENTRY Keypad (29) to enter desired frequency and press ENTER Key.
  - To edit AF Generator Level, press 3 DATA ENTRY Key (29). A data field appears displaying current level. Use DATA ENTRY Keypad (29) to enter desired level and press ENTER Key.
25. To select a meter, press "More" Soft Function Key F6 until "Meters" Soft Function Key F4 appears:
- For FM Modulation, press "Meters" Soft Function Key F4 to select SINAD, Distortion, Deviation (RMS) or DMM Meter.
 

**NOTE:** Deviation (RMS) Meter reading may be invalid with Deviation (Peak) Meter Range >10 kHz.
  - For PM Modulation, press "Meters" Soft Function Key F4 to select SINAD, Distortion, Phase (RMS) or DMM Meter.
  - For AM Modulation, press "Modul"/"Dist" Soft Function Key F4 to toggle between Modulation or Distortion Meter. DMM Meter is displayed with either selection.
  - For USB, LSB or BFO Modulation press "DMM" Soft Function Key F3 until "DMM" appears in red and DMM Meter is displayed.

## STEP

## PROCEDURE

- 
26. To zero Deviation Meter if displayed, press "More" Soft Function Key F6 until "FM Z" Soft Function Key F3 appears. Press "FM Z" Soft Function Key F3. To abort zeroing process, press Soft Function Key F3 before "FM Z" reappears.
  27. To edit a Meters settings, move cursor to Callout of Meter to be edited and press ENTER Key. Meter's Operation Screen appears.
    - For Frequency Error Meter/Frequency Meter Operation Procedures, see 4-8-2.
    - For AF Meter Operation Procedures, see 4-8-1.
    - For Deviation Meter Operation Procedures, see 4-8-4.
    - For Phase Meter Operation Procedures, see 4-8-11.
    - For AM Modulation Meter Operation Procedures, see 4-8-5.
    - For Distortion Meter Operation Procedures, see 4-8-6.
    - For Power Meter Operation Procedures, see 4-8-3.
    - For Signal Strength Meter Operation Procedures, see 4-8-8.
    - For SINAD Meter Operation Procedures, see 4-8-7.
    - For Deviation (RMS) Meter Operation Procedures, see 4-8-12.
    - For Phase (RMS) Meter Operation Procedures, see 4-8-13.
    - For DMM Meter Operation Procedures, see 4-8-10.
  28. To tune USB, LSB or BFO Modulation, press "Tune" Soft Function Key F4. Use DATA SCROLL ↑ and ↓ Keys (3) to tune receiver in 125 Hz steps. Press ENTER Key.
  29. To operate Find Function:
    - Press "More" Soft Function Key F6 until "Disp" Soft Function Key F1 appears. Press "Disp" Soft Function Key F1 to display a menu listing Oscilloscope and Analyzer options.
    - Press 2 DATA ENTRY Key (29) to select full size Analyzer.
    - Press "More" Soft Function Key F6 and press "Find lvl" Soft Function Key F2. Find Level is indicated by a red horizontal line. Use DATA SCROLL Spinner (2) or DATA SCROLL ↑ and ↓ Keys (3) to adjust Find Level and press ENTER Key.
    - Press "Find" Soft Function Key F1 to activate Find Function. Receiver Frequency is changed to frequency found.

### Channel Mode

30. To operate Receiver in Channel Mode, press SETUP Key to display Receiver Menu.
- Move cursor to "10. Operation Mode" and press ENTER Key. Press 2 DATA ENTRY Key (29) to select Receiver Channel Mode.
  - Press "Chan" Soft Function Key F2 to display a submenu listing cellular formats. Use DATA ENTRY Keypad (29) to select a cellular format.
  - Press "Ret" Soft Function Key F5 to return to Receiver Operation Screen. Receiver Frequency is displayed by channel number.
  - See the following Appendices for listings of cellular channels and corresponding frequencies:

CHANNEL FORMAT	APPENDIX
NADC/NAMPS	B
E-TACS	C

### Direct Mode

31. To operate Receiver in Direct Mode, press "More" Soft Function Key F6 until "Mode" Soft Function Key F2 appears. Press "Mode" Soft Function Key F2 and press 1 DATA ENTRY Key (29) to select Direct Mode.

### Frequency Scan Mode

32. To operate Receiver Scan Function, press SETUP Key to display Receiver Menu. Press "Scan" Soft Function Key F1 to display RF Frequency Scan Menu:

5. Select AGC Type User Defined

6. RF Frequency Scan

7.

8. 1. Start Freq 1.0000 MHz

9. 2. Stop Freq 10.0000 MHz

10. 3. Increment 1.0000 MHz

11. 4. Scan Rate 0.01 Sec

5. Pause Time 1.0 Sec

RF lock F.L. Ret ESC

8610346

- Press 1 DATA ENTRY Key (29) and use DATA ENTRY Keypad (29) to enter Starting Frequency (Starting Frequency must be less than Ending Frequency). Press ENTER Key.
- Press 2 DATA ENTRY Key (29) and use DATA ENTRY Keypad (29) to enter Ending Frequency. Press ENTER Key.
- Press 3 DATA ENTRY Key (29) and use DATA ENTRY Keypad (29) to enter Increment. Press ENTER Key.

- Press 4 DATA ENTRY Key (29) and use DATA ENTRY Keypad (29) to enter Scan Rate. Press ENTER Key.
- Press 5 DATA ENTRY Key (29) and use DATA ENTRY Keypad (29) to enter Pause Time. Press ENTER Key. Zero Pause Time causes receiver Scan to remain on a frequency until squelch is no longer broken.
- Press "Ret" Soft Function Key F5 to return to Receiver Operation Screen.
- Press "More" Soft Function Key F6 until "Mode" Soft Function Key F2 appears. Press "Mode" Soft Function Key F2 and press 3 DATA ENTRY Key (29) to select Receiver Frequency Scan Operation Mode.
- Press GO TEST CONTROL Key (28) to start Receiver Scan. Press STOP TEST CONTROL Key (28) to stop Scanning. Pressing GO TEST CONTROL Key (28) again resumes scanning operation. Press SGL STEP TEST CONTROL Key (28) to single step through scanning operation one increment at a time.
- To return Receiver Operation Mode to Direct Operation, press "More" Soft Function Key F6 until "Mode" Soft Function Key F2 appears. Press "Mode" Soft Function Key F2 and press 1 DATA ENTRY Key (29) to select Receiver Direct Operation Mode.
- To activate RF Lock feature, press SETUP Key to display Receiver Menu. Press "RF lock" Soft Function Key F2. "RF lock" appears in red while active.

The following steps use the Frequency List (F.L.) that is shared between the RF Generator, Receiver, Duplex, Duplex Transmitter and Duplex Receiver Operation Screens. The Frequency List can be used as a list to manually select different frequencies or as a table for scanning. When used for scanning, specific frequencies in the Frequency List must be manually toggled On or Off.

### Frequency List Mode

33. To operate Receiver in Frequency List Mode, press SETUP Key to display the Receiver Setup Menu. Press  $\uparrow$  or  $\downarrow$  FIELD SELECT Keys (1) to move cursor to "10. Operation Mode." Press ENTER Key to display the Receiver Operation Mode Menu. Press 4 DATA ENTRY Key (29) to select Freq List. Press "F.L." Soft Function Key F4 to display the Stored RF Frequency List.
  - Press  $\uparrow$  or  $\downarrow$  FIELD SELECT Keys (1), in conjunction with "Pg Up" or "Pg Dn" Soft Function Keys F1 and F2, as needed, to move cursor to desired Item line in the Frequency List.
  - Press  $\leftarrow$  or  $\rightarrow$  FIELD SELECT Keys (1) as needed to move cursor to select the Generate, Receive or Offset entries (Offset frequency is equal to Generate frequency minus Receive frequency). Press ENTER Key to activate the data field and use DATA ENTRY Keypad (29) to enter desired frequency. Press ENTER Key.
  - Continue selecting Item lines and entering frequency values until desired Frequency List is created.
  - Press "Clear" Soft Function Key F3 to return the frequency entry selected by the cursor to 0.2500 MHz, the lowest frequency allowable.

- Press "Fill" Soft Function Key F4 to copy the selected frequency entry value into all entries listed below in the same column.
- Press "Ret" Soft Function Key F5 to return to Receiver Operation Screen.
- Press "More" Soft Function Key F6 until "Freq" Soft Function Key F1 appears. Press "Freq" Soft Function Key F1 to activate the data field of the Frequency List Item number. Press ↑ or ↓ DATA SCROLL Keys (3) to select desired frequency. Press ENTER Key.

### Frequency List Scan Mode

34. To operate Receiver in Frequency List Scan Mode, press SETUP Key to display the Receiver Setup Menu. Press ↑ or ↓ FIELD SELECT Keys (1) to move cursor to "10. Operation Mode." Press ENTER Key to display the Receiver Operation Mode Menu. Press 5 DATA ENTRY Key (29) to select Freq List Scan. Press "F.L." Soft Function Key F4 to display the Stored RF Frequency List.
- Refer to Step 33, Frequency List Mode, to create the desired listing of frequencies.
  - Use the FIELD SELECT Keys (1) and the ENTER Key to toggle the Scan "switch" to 'on' or 'off' for each Item listing. Item listings that are turned off are skipped when the scan operation is activated.
  - Press "Ret" Soft Function Key F5 to return to Receiver Operation Screen.
  - Press GO TEST CONTROL Key (28) to start Receiver Scan. Press STOP TEST CONTROL Key (28) to stop Scanning. Pressing GO TEST CONTROL Key (28) again resumes scanning operation. Press SGL STEP TEST CONTROL Key (28) to single step through scanning operation one increment at a time.
  - While scanning or single stepping through the Frequency List, the operation begins again at the first "turned-on" frequency listing after reaching the last frequency listing.
  - To return Receiver Operation Mode to Direct Operation, press "More" Soft Function Key F6 until "Mode" Soft Function Key F2 appears. Press "Mode" Soft Function Key F2 and press 1 DATA ENTRY Key (29) to select Receiver Direct Operation Mode.

**NOTE:** To store or recall a set of screen parameters, see 4-1-1.

## 4-3-2 RECEIVING FM SIGNALS

**EXAMPLE:** The following example receives a 90 MHz FM modulated signal "off the air" and routes demodulated signal to AUDIO OUT Connector (14) and Test Set Speaker.

STEP	PROCEDURE
1.	Connect external antenna to ANTENNA IN Connector (25).
2.	Move cursor to RF (37) and press 9 and 0 DATA ENTRY Keys (29) to set Receiver Frequency to <b>90.0000 MHz</b> . Press ENTER Key.
3.	Move cursor to MOD (40), use DATA SCROLL ↑ and ↓ Keys (3) to select a FM Modulation and press ENTER Key.
4.	Move cursor to RF IN (36) and press ENTER Key to toggle RF Input Location until <b>ANT</b> (ANTENNA IN Connector [25]) appears.
5.	If Signal Strength Meter reading is greater than 90, move cursor to Receiver Input Attenuation Level (35), press DATA SCROLL Keys ↑ and ↓ (3) to select greater attenuation and press ENTER Key.
6.	Press a SQLCH Key (10) to display Squelch data field. Press SQLCH Keys (10) until squelch is broken and press ENTER Key.
7.	Press SETUP Key to access Receiver Menu. <ul style="list-style-type: none"><li>● Press 6 DATA ENTRY Key (29) to toggle "Rcvr Out Speaker" until <b>On</b> appears.</li><li>● Press 7 DATA ENTRY Key (29) to toggle "Rcvr Out Audio Out" until <b>On</b> appears.</li><li>● Press "Ret" Soft Function Key F5 to return to Operation Screen.</li></ul>
8.	Press a VOL Key (5) to display Volume data field. Press VOL Keys (5) to adjust volume to desired level and press ENTER Key.

### 4-3-3 RECEIVING AM SIGNALS

**EXAMPLE:** The following example receives a 850 kHz FM modulated signal and routes demodulated signal to AUDIO OUT Connector (14) and Test Set Speaker.

STEP	PROCEDURE
1.	Connect external antenna to ANTENNA IN Connector (25).
2.	Move cursor to RF (37) and press •, 8 and 5 DATA ENTRY Keys (29) to set Receiver Frequency to <b>0.8500 MHz</b> . Press ENTER Key.
3.	Move cursor to MOD (40), use DATA SCROLL Keys ↑ and ↓ (3) to select an AM Modulation and press ENTER Key.
4.	Move cursor to RF IN (36) and press ENTER Key to toggle RF Input Location until <b>ANT</b> (ANTENNA IN Connector [25]) appears.
5.	If Signal Strength Meter reading is greater than 90, move cursor to Receiver Input Attenuation Level (35), press DATA SCROLL ↑ and ↓ Keys (3) to select greater attenuation and press ENTER Key.
6.	Press a SQLCH Key (10) to display Squelch data field. Press SQLCH Keys (10) until squelch is broken and press ENTER Key.
7.	Press SETUP Key to access Receiver Menu. <ul style="list-style-type: none"><li>● Press 6 DATA ENTRY Key (29) to toggle "Rcvr Out Speaker" until <b>On</b> appears.</li><li>● Press 7 DATA ENTRY Key (29) to toggle "Rcvr Out Audio Out" until <b>On</b> appears.</li><li>● Press "Ret" Soft Function Key F5 to return to Operation Screen.</li></ul>
8.	Press a VOL Key (5) to display Volume data field. Press VOL Keys (5) to adjust volume to desired level and press ENTER Key.



#### 4-3-4 DECODING DTMF CODED SIGNALS

**EXAMPLE:** The following example receives a 450 MHz FM modulated DTMF signal and routes demodulated signal to AUDIO OUT Connector (14) and Test Set Speaker.

STEP	PROCEDURE
1.	Connect coaxial cable from UUT to T/R Connector (6).
2.	Move cursor to RF (37) and press 4, 5 and 0 DATA ENTRY Keys (29) to set Receiver Frequency to <b>450.0000 MHz</b> . Press ENTER Key.
3.	Move cursor to MOD (40), press DATA SCROLL ↑ Key (3) until <b>FM1</b> appears in data field and press ENTER Key.
4.	Move cursor to RF IN (36) and press ENTER Key to toggle RF Input Location to <b>T/R</b> .
5.	Press a SQLCH Key (10) to display Squelch data field. Press SQLCH Keys (10) until squelch is broken and press ENTER Key.
6.	Press SETUP Key to access Receiver Menu. <ul style="list-style-type: none"><li>● Move cursor to "11. Signaling Formats" and press ENTER Key. Press 1 DATA ENTRY Key (29) to select DTMF.</li><li>● Press 6 DATA ENTRY Key (29) to toggle "Rcvr Out Speaker" until <b>On</b> appears.</li><li>● Press 7 DATA ENTRY Key (29) to toggle "Rcvr Out Audio Out" until <b>On</b> appears.</li><li>● Press "Ret" Soft Function Key F5 to return to Operation Screen.</li></ul>
7.	Press a VOL Key (5) to display Volume data field. Press VOL Keys (5) to adjust volume to desired level and press ENTER Key.
8.	Press "More" Soft Function Key F6 until "Disp" Soft Function Key F1 appears. Press "Disp" Soft Function Key F1 and press 5 DATA ENTRY Key (29).
9.	"Decode" Soft Function Key F2 appears. Press "Decode" Soft Function Key F2. Decoded digits appear below DTMF Callout. To stop decoding, press "Stop" Soft Function Key F3.

#### 4-3-5 DECODING AUDIO CCIR CODED SIGNALS

**EXAMPLE:** The following example receives a 450 MHz FM modulated Audio signal and routes demodulated signal to AUDIO OUT Connector (14) and Test Set Speaker.

STEP	PROCEDURE
1.	Connect external antenna to ANTENNA IN Connector (25).
2.	Move cursor to RF (37) and press 4, 5 and 0 DATA ENTRY Keys (29) to set Receiver Frequency to <b>450.0000 MHz</b> . Press ENTER Key.
3.	Move cursor to MOD (40), use DATA SCROLL Keys ↑ and ↓ (3) to select a FM Modulation and press ENTER Key.
4.	Move cursor to RF IN (36) and press ENTER Key to toggle RF Input Location until <b>ANT</b> (ANTENNA IN Connector [25]) appears.
5.	If Signal Strength Meter reading is >90, move cursor to Receiver Input Attenuation Level (35), press DATA SCROLL Keys ↑ and ↓ (3) to select greater attenuation and press ENTER Key.
6.	Press a SQLCH Key (10) to display Squelch data field. Press SQLCH Keys (10) until squelch is broken and press ENTER Key.
7.	Press SETUP Key to access Receiver Menu. <ul style="list-style-type: none"><li>● Move cursor to "11. Signaling Formats" and press ENTER Key. Press 2 DATA ENTRY Key (29) to select Audio. Press 1 DATA ENTRY Key (29) to select <b>CCIR</b>.</li><li>● Press 6 DATA ENTRY Key (29) to toggle "Rcvr Out Speaker" until <b>On</b> appears.</li><li>● Press 7 DATA ENTRY Key (29) to toggle "Rcvr Out Audio Out" until <b>On</b> appears.</li><li>● Press "Ret" Soft Function Key F5 to return to Operation Screen.</li></ul>
8.	Press a VOL Key (5) to display Volume data field. Press VOL Keys (5) to adjust volume to desired level and press ENTER Key.
9.	Press "More" Soft Function Key F6 until "Disp" Soft Function Key F1 appears. Press "Disp" Soft Function Key F1 and press 5 DATA ENTRY Key (29).
10.	"Extend" Soft Function Key F5 appears. Press "Extend" Soft Function Key F5 to display Extend Screen.
11.	Press "Input" Soft Function Key F1 and press 1 DATA ENTRY Key (29) to select Demod Audio Input.
12.	Press "Decode" Soft Function Key F2. Decoded digits, frequencies, frequency errors and time durations are displayed. To stop decoding, press "Stop" Soft Function Key F3.

#### 4-3-6 DECODING AUDIO USER DEFINED CODED SIGNALS

**EXAMPLE:** The following example receives a 450 MHz FM modulated Audio signal and routes demodulated signal to AUDIO OUT Connector (14) and Test Set Speaker.

STEP	PROCEDURE
1.	Press REC MODE Key (27) and press SETUP Key to display Receiver Menu. Move cursor to "11. Signaling Formats" and press ENTER Key.
2.	Press 2 DATA ENTRY Key (29) to select Audio. Audio Code Menu appears. Move cursor to "12. User Defined" and press ENTER Key. Audio Define Tones Menu appears.
3.	Move cursor to Tone(Hz) location in 0 row. Press 9, 0 and 0 DATA ENTRY (29) Keys and press ENTER Key. Press FIELD SELECT → Key (1) to move cursor to Duration(ms) column. Press 1, 5 and 0 DATA ENTRY Keys (29) and press ENTER Key.
4.	Move cursor to Tone(Hz) location in 1 row. Press 1, 1, 0 and 0 DATA ENTRY Keys and press ENTER Key. Press FIELD SELECT → Key (1) to move cursor to Duration(ms) column. Press 8 and 0 DATA ENTRY Keys (29) and press ENTER Key.
5.	Move cursor to Tone(Hz) location in 2 row. Press 1, 2, 0 and 0 DATA ENTRY (29) Keys and press ENTER Key. Press FIELD SELECT → Key (1) to move cursor to Duration(ms) column. Press 8 and 0 DATA ENTRY Keys (29) and press ENTER Key.
6.	Move cursor to Tone(Hz) location in 3 row. Press 1, 3, 0 and 0 DATA ENTRY Keys (29) and press ENTER Key. Press FIELD SELECT → Key (1) to move cursor to Duration(ms) column. Press 8 and 0 DATA ENTRY Keys (29) and press ENTER Key.
7.	Move cursor to Tone(Hz) location in 4 row. Press 1, 4, 0 and 0 DATA ENTRY Keys (29) and press ENTER Key. Press FIELD SELECT → Key (1) to move cursor to Duration(ms) column. Press 8 and 0 DATA ENTRY Keys (29) and press ENTER Key.
8.	Move cursor to Tone(Hz) location in A row. Press 0 DATA ENTRY Key (29) and press ENTER Key. Press FIELD SELECT → Key (1) to move cursor to Duration(ms) column. Press 4 and 0 DATA ENTRY Keys (29) and press ENTER Key.
	<b>NOTE:</b> Tones 0, 1, 2, 3, 4 and A are now defined. Receiver uses all defined tones as the User Defined Code when decoding.
9.	Press "ESC" Soft Function Key F6. Press "Ret" Soft Function Key F6 to return to Receiver Operation Screen.
10.	Connect external antenna to ANTENNA IN Connector (25).
11.	Move cursor to RF (37) and press 4, 5 and 0 DATA ENTRY Keys (29) to set Receiver Frequency to <b>450.0000 MHz</b> . Press ENTER Key.
12.	Move cursor to MOD (40) and use DATA SCROLL Keys ↑ and ↓ (3) to select a FM Modulation and press ENTER Key.
13.	Move cursor to RF IN (36) and press ENTER Key until <b>ANT</b> appears as RF Input Location.

## STEP

## PROCEDURE

- 
14. If Signal Strength Meter reading is greater than 90, move cursor to RF Input Attenuation (35) and press DATA SCROLL Keys ↑ and ↓ (3) to select greater attenuation. Press ENTER Key.
  15. Press a SQLCH Key (10) to display Squelch data field. Press SQLCH Keys (10) until squelch is broken and press ENTER Key.
  16. Press SETUP Key to access Receiver Menu.
    - Press 6 DATA ENTRY Key (29) to toggle "Rcvr Out Speaker" until **On** appears.
    - Press 7 DATA ENTRY Key (29) to toggle "Rcvr Out Audio Out" until **On** appears.
    - Press "Ret" Soft Function Key F5 to return to Operation Screen.
  17. Press a VOL Key (5) to display Volume data field. Press VOL Keys (5) to adjust volume to desired level and press ENTER Key.
  18. Press "More" Soft Function Key F6 until "Disp" Soft Function Key F1 appears. Press "Disp" Soft Function Key F1 and press 5 DATA ENTRY Key (29).
  19. "Extend" Soft Function Key F5 appears. Press "Extend" Soft Function Key F5 to display Extend Screen.
  20. Press "Input" Soft Function Key F1 and press 1 DATA ENTRY Key (29) to select Demod Audio Input.
  21. Press "Decode" Soft Function Key F2. Decoded digits, frequencies, frequency errors and time durations are displayed. To stop decoding before decoding process is finished, press "Stop" Soft Function Key F3.

## 4-3-7 DECODING DCS CODED SIGNALS

**EXAMPLE:** The following example receives a 450 MHz FM modulated DCS signal and routes demodulated signal to AUDIO OUT Connector (14) and Test Set Speaker.

STEP	PROCEDURE
1.	Connect external antenna to ANTENNA IN Connector (25).
2.	Move cursor to RF (37) and press 4, 5 and 0 DATA ENTRY Keys (29) to set Receiver Frequency to <b>450.0000 MHz</b> . Press ENTER Key.
3.	Move cursor to MOD (40) and use DATA SCROLL ↑ and ↓ Keys (3) to select an FM Modulation and press ENTER Key.
4.	Move cursor to RF IN (36) and press ENTER Key to toggle RF Input Location until <b>ANT</b> (ANTENNA IN Connector [25]) appears.
5.	If Signal Strength Meter reading is greater than 90, move cursor to Receiver Input Attenuation Level (35), press DATA SCROLL Keys ↑ and ↓ (3) to select greater attenuation and press ENTER Key.
6.	Press a SQLCH Key (10) to display Squelch data field. Press SQLCH Keys (10) until squelch is broken and press ENTER Key.
7.	Press SETUP Key to access Receiver Menu. <ul style="list-style-type: none"><li>● Move cursor to "11. Signaling Formats" and press ENTER Key. Press 3 DATA ENTRY Key (29) to select Digital. Press 1 DATA ENTRY Key (29) to select DCS.</li><li>● Press 6 DATA ENTRY Key (29) to toggle "Rcvr Out Speaker" until <b>On</b> appears.</li><li>● Press 7 DATA ENTRY Key (29) to toggle "Rcvr Out Audio Out" until <b>On</b> appears.</li><li>● Press "Ret" Soft Function Key F5 to return to Operation Screen.</li></ul>
8.	Press a VOL Key (5) to display Volume data field. Press VOL Keys (5) to adjust volume to desired level and press ENTER Key.
9.	Press "More" Soft Function Key F6 until "Disp" Soft Function Key F1 appears. Press "Disp" Soft Function Key F1 and press 5 DATA ENTRY Key (29).
10.	Press "Input" Soft Function Key F5 to display Decode Input Submenu. Press 1 DATA ENTRY Key (29) to select "Demod Audio".
11.	Press "Decode" Soft Function Key F2. Decoded digits appear below DCS Code Callout. To stop decoding, press "Stop" Soft Function Key F3.

## 4-3-8 DECODING POCSAG CODED SIGNALS

**EXAMPLE:** The following example receives a 450 MHz FM modulated POCSAG signal and routes demodulated signal to AUDIO OUT Connector (14) and Test Set Speaker.

STEP	PROCEDURE
1.	Connect external antenna to ANTENNA IN Connector (25).
2.	Move cursor to RF (37) and press 4, 5 and 0 DATA ENTRY Keys (29) to set Receiver Frequency to <b>450.0000 MHz</b> . Press ENTER Key.
3.	Move cursor to MOD (40), use DATA SCROLL Keys (3) to select a FM Modulation and press ENTER Key.
4.	Move cursor to RF IN (36) and press ENTER Key to toggle RF Input Location until <b>ANT</b> (ANTENNA IN Connector [25]) appears.
5.	If Signal Strength Meter reading is greater than 90, move cursor to RF Input Attenuation (35), press DATA SCROLL Keys ↑ and ↓ (3) to select greater attenuation and press ENTER Key.
6.	Press a SQLCH Key (10) to display Squelch data field. Press SQLCH Keys (10) until squelch is broken and press ENTER Key.
7.	Press SETUP Key to access Receiver Menu. <ul style="list-style-type: none"><li>● Move cursor to "11. Signaling Formats" and press ENTER Key. Press 3 DATA ENTRY Key (29) to select Digital. Press 3 DATA ENTRY Key (29) to select POCSAG.</li><li>● Press 6 DATA ENTRY Key (29) to toggle "Rcvr Out Speaker" until <b>On</b> appears.</li><li>● Press 7 DATA ENTRY Key (29) to toggle "Rcvr Out Audio Out" until <b>On</b> appears.</li><li>● Press "Ret" Soft Function Key F5 to return to Operation Screen.</li></ul>
8.	Press a VOL Key (5) to display Volume data field. Press VOL Keys (5) to adjust volume to desired level and press ENTER Key.
9.	Press "More" Soft Function Key F6 until "Disp" Soft Function Key F1 appears. Press "Disp" Soft Function Key F1 and press 5 DATA ENTRY Key (29).
10.	"Extend" Soft Function Key F5 appears. Press "Extend" Soft Function Key F5 to display Extend Screen.
11.	Press "Input" Soft Function Key F1 and press 1 DATA ENTRY Key (29) to select Demod Audio Input.
12.	Press "Decode" Soft Function Key F4. Decoded digits, frequencies, frequency errors and time durations are displayed.

## 4-3-9 MEASURING AM OR FM TRANSMITTER DISTORTION

STEP	PROCEDURE
1.	Press AF GEN MODE Key (27) and press SETUP Key to access AF Gen Menu.
2.	Press 5 DATA ENTRY Key (29) to access AF Output Menu. Press 1 DATA ENTRY Key (29) to toggle "To Audio Out Conn" until "On" appears.
3.	Press 4 DATA ENTRY Key (29) to access Function Generator Out Level. Press 1 DATA ENTRY Key (29) to set Level to <b>1.0000 V</b> and press ENTER Key.
4.	Press 5 DATA ENTRY Key (29) to toggle Proportional Output until <b>Off</b> appears.
5.	Press "ESC" Soft Function Key F6 and 1 DATA ENTRY Key (29) to access Function Generator 1 Menu.
6.	Press 1 DATA ENTRY Key (29) until Generator is <b>On</b> .
7.	Press 2 DATA ENTRY Key (29) and press 1, 0, 0 and 0 DATA ENTRY Keys (29) to set Frequency to <b>1000.0 Hz</b> . Press ENTER Key.
8.	Press 3 DATA ENTRY Key (29) press 1 DATA ENTRY Key (29) to select <b>Sine</b> .
9.	Press MTRS MODE Key (27) to exit AF Gen Menu. Press 6 DATA ENTRY Key (29) to access Distortion Meter Operation Screen.
10.	Move cursor to INPUT and press DATA SCROLL Keys ↑ and ↓ (3) until <b>SINAD/BER</b> appears. Press ENTER Key.
11.	Move cursor to NOTCH FREQ and press ENTER Key. Press 1, 0, 0 and 0 DATA ENTRY Keys (29) to set Notch Frequency to <b>1000 Hz</b> and press ENTER Key.
12.	Move cursor to FILTER and press ENTER Key until <b>Low Pass</b> appears. Press FIELD SELECT → Key to move cursor to the cutoff frequency field and press ENTER Key. Press 3 DATA ENTRY Key (29) to set Low-Pass cutoff frequency to <b>3.000 kHz</b> and press ENTER Key.
	<b>NOTE:</b> FILTER (Post Detection Filter) setting is for general use only. Other settings may be used as needed.
13.	Move cursor to PEAK HOLD and press ENTER Key to toggle Peak Hold until <b>Off</b> appears.
14.	Move cursor to AVERAGE and press ENTER Key to toggle Average until <b>On</b> appears.
15.	Connect SINAD/BER IN Connector (15) to AUDIO OUT Connector (14). Record Distortion Meter reading as the AF Generator distortion.
16.	Move cursor to INPUT and use DATA SCROLL Keys ↑ and ↓ (3) to select <b>Demod Audio</b> . Press ENTER Key.
17.	Disconnect SINAD/BER IN Connector (15) and connect UUT Audio Input to AUDIO OUT Connector (14). Connect Transmitter Output to T/R Connector (6) using 50 Ω coaxial cable.

## STEP

## PROCEDURE

- 
18. Press RCVR MODE Key (27) to access Receiver Operation Screen.
  19. Move cursor to RF (37) and press ENTER Key. Use DATA ENTRY Keypad (29) to select Receiver Frequency (38) to UUT Transmitting Frequency and press ENTER Key.
  20. Use FIELD SELECT Keys (1) to move cursor to MOD (40) and press ENTER Key.
  21. If AM Transmitter is being tested:
    - Use DATA SCROLL Keys ↑ and ↓ (3) to set Receiver Modulation Type (41) to either **AM1** or **AM2**, whichever results in lower Distortion reading.
    - Press "More" Soft Function Key F6 until "Af Gen" Soft Function Key F1 appears and press "Af Gen" Soft Function Key F1. Press 3 DATA ENTRY Key (29) to access AF Generator Output Level. Press DATA SCROLL ↑ and ↓ Keys (3) until Modulation reads **25 %** and press ENTER Key.
    - Subtract recorded AF Generator distortion from current Distortion Meter reading. Result is AM Transmitter Distortion.
  22. If FM Transmitter is being tested:
    - Use DATA SCROLL Keys ↑ and ↓ (3) to set Receiver Modulation Type (41) to either **FM1**, **FM2**, **FM3** or **FM4**, whichever results in lowest Distortion reading.
    - Press "More" Soft Function Key F6 until "Af Gen" Soft Function Key F1 appears and press "Af Gen" Soft Function Key F1. Press 3 DATA ENTRY Key (29) to access AF Generator Output Level. Press DATA SCROLL ↑ and ↓ Keys (3) until Deviation reads **5.0 kHz** and press ENTER Key.
    - If Deviation Meter readings are not centered, press "FM Z" Soft Function Key F3 to zero the Deviation Meter.
    - Subtract recorded AF Generator distortion from current Distortion Meter reading. Result is FM Transmitter Distortion.



## 4-4 DUPLEX OPERATION

Duplex Output signals are routed to T/R Connector (6) or DUPLEX OUT Connector (24). Low-power (-65 to 0 dBm) RF signals are monitored "off the air" from ANTENNA IN Connector (25) or high power RF signals (-5 to +47 dBm) are monitored through T/R Connector (6).

**CAUTION:** MAXIMUM CONTINUOUS INPUT TO ANTENNA IN CONNECTOR (25) IS LIMITED TO 10 W.

MAXIMUM CONTINUOUS INPUT TO T/R CONNECTOR (6) IS LIMITED TO 50 W.

**NOTE:** Valid Duplex Operation Screen meter readings are not displayed until Squelch is broken.

DUPLEX OPERATION SCREEN WITH SQUELCH UNBROKEN

TRANSMITTER	DUP	RECEIVER
RF 10.0000 MHz •		RF 10.5000 MHz
MOD TYPE FM1		OFST 0.5000 MHz
RF IN ANT OdB		OUT DPL -26.5 dBm
FREQ		SOURCE
		1 2 3 Ext Mic
FREQ ERR		MOD TYPE FM
SIG + --- kHz		DEV 4.0 kHz
AF --- kHz		AF FREQ1000.0 Hz
		WAVE Sine
DEVIATION		DIST 20.0%
--- kHz		
<b>TX</b>	<b>RX</b>	<b>SINAD</b> <b>Offset</b> <b>Sp Tst</b>

03416125

DUPLEX OPERATION SCREEN WITH SQUELCH BROKEN

TRANSMITTER	DUP	RECEIVER
RF 10.0000 MHz •		RF 10.5000 MHz
MOD TYPE FM1		OFST 0.5000 MHz
RF IN ANT OdB		OUT DPL -26.5 dBm
FREQ		SOURCE
10.000651		1 2 3 Ext Mic
FREQ ERR		MOD TYPE FM
SIG + 0.651 kHz		DEV 4.0 kHz
AF 29		AF FREQ1000.0 Hz
AF 1.834 kHz		WAVE Sine
DEVIATION		DIST 20.0%
4.03 kHz		
<b>TX</b>	<b>RX</b>	<b>SINAD</b> <b>Offset</b> <b>Sp Tst</b>

03416126

### 4-4-1 DUPLEX GENERAL OPERATION

The Duplex Transmitter tests Transmitting UUTs and functions as a Receiver. The Duplex Receiver tests Receiving UUTs and functions as an RF Generator.

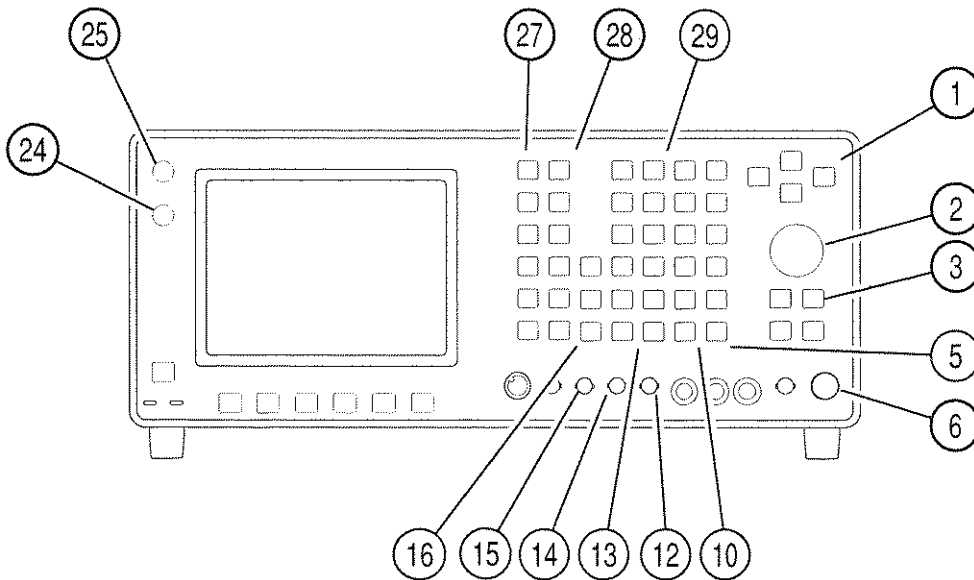

03407011

1. Press DPLX MODE Key (27). Duplex Operation Screen appears on color display.

**NOTE:** Duplex Transmitter menu is accessed by pressing SETUP Key when cursor is located in left half of Duplex Operation Screen. Duplex Receiver menu is accessed by pressing SETUP Key when cursor is located in right half of Duplex Operation Screen.

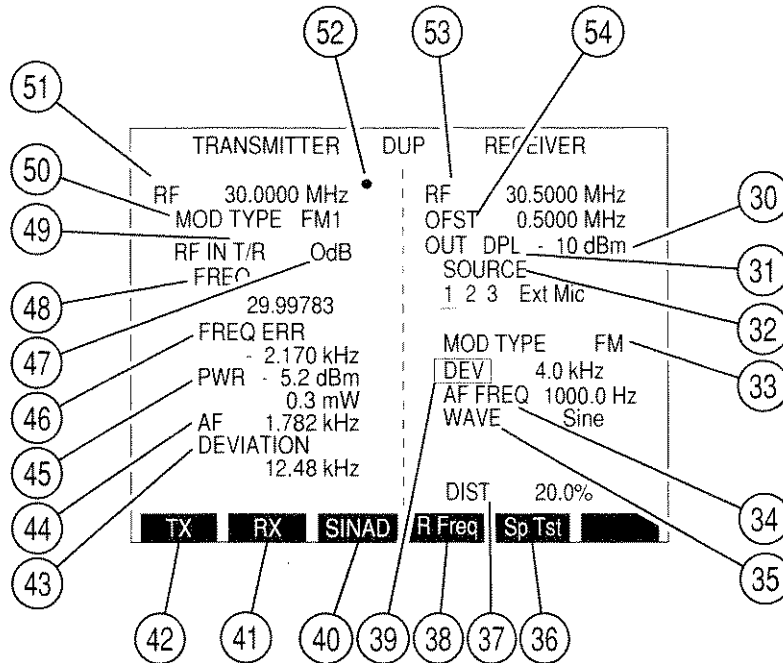

03416127

2. Move cursor to RF IN data field (49) and press ENTER Key to toggle RF Input location between "ANT" and "T/R" to match input location of received signal.
3. Move cursor to FREQ (51) and use DATA ENTRY Keypad (29) to enter desired setting in MHz. Press ENTER Key.
 

**NOTE:** RF Frequency Error Meter may provide inaccurate results when Deviation Meter readings exceed Deviation Meter Range.
4. To adjust squelch level, press a SQLCH Key (10). Squelch data field appears on color display. Press SQLCH Keys (10) to adjust Squelch and press ENTER Key.
5. To adjust volume, press a VOL Key (5). Volume data field appears on color display. Press VOL Keys (5) to adjust Volume and press ENTER Key.
6. Move cursor to Duplex Input Attenuation Level (47) and press ENTER Key. Use DATA ENTRY Keypad (29) to enter desired level and press ENTER Key.
7. Move cursor to MOD TYPE (50) and press ENTER Key. Press DATA SCROLL ↑ or ↓ Keys (3) until desired setting appears in data field and press ENTER Key. See Table 3-2 for description of modulation types.

8. If User is selected for MOD TYPE (50), press SETUP Key to access Duplex Transmitter Menu. Press 2 DATA ENTRY Key (29) to display Duplex Transmitter Modulation Menu and press ENTER Key. User Defined Modulation Menu appears:

Duplex Transmitter Menu	
1. Set Rcvr Freq	200.0000MHz
2. Select Mod	User Defined
3. 1. Modulation	FM DATA
4. 2. IF Filters	3 KHz
5. 3. Post Detection	All Pass
6.	
7. Rcvr Out Audio Out	Off
8. Rcvr Out Demod Out	On
9. Auto Volume Level	Off
10. Operation Mode	Freq Scan
11. Signaling Formats	DTMF
Scan    F.L.    Ret    ESC	

8610351

- Press 1 DATA ENTRY Key (29) and use DATA ENTRY Keypad (29) to select User Modulation Type.
  - Press 2 DATA ENTRY Key (29) and use DATA ENTRY Keypad (29) to select an IF Filter.
  - Press 3 DATA ENTRY Key (29) and use DATA ENTRY Keypad (29) to select a Post Detection Filter. If Low Pass, High Pass or Band Pass is selected, a cutoff frequency data field appears. Use DATA ENTRY Keypad (29) to enter cutoff frequencies and press ENTER Key.
  - Press "Ret" Soft Function Key F5 to return to Duplex Operation Screen.
9. Press "Offset" or "R Freq" Soft Function Key F4 to toggle which frequency is editable or display-only. The display-only parameter, RF (53) or OFST (54), appears in red. Move cursor to editable parameter and use DATA ENTRY Keypad (29) to enter desired frequency. Press ENTER Key.
- NOTE:** When Duplex Offset Frequency (OFST) or Duplex Receiver Frequency (RX) is edited, the other automatically adjusts to maintain a difference equal to the Duplex Transmitter Frequency (TX). The difference is equal to Duplex Receiver Frequency (RX) minus Duplex Offset Frequency (OFST)
10. Move cursor to Duplex Receiver Output Connector (31) and press ENTER Key to toggle Duplex Receiver Output Connector to "DPL" (DUPLEX OUT Connector) (24) or "T/R" (T/R Connector) (6).
11. Move cursor to Duplex Receiver Output Level (30) and press ENTER Key. Use DATA ENTRY Keypad (29) to enter desired level and press ENTER Key. If necessary, press +/- DATA ENTRY Key (29) to place "-" in data field.
- NOTE:** Duplex Receiver Output Level is limited to -20 dBm when a signal greater than 2 W is received at T/R Connector (6) and T/R Connector (6) is selected as Duplex Receiver Output Connector.

12. Move cursor to SOURCE (32) and press ENTER Key to access active Modulation Source. Use FIELD SELECT ← and → Keys (1) to place cursor over desired source and use DATA SCROLL ↑ or ↓ Keys (3) to select desired Modulation Type. White indicates OFF, red indicates AM, yellow indicates FM and green indicates PM. Last selected Modulation Type is displayed with MOD TYPE Callout (33). Source parameters are shown for last selected source, signified by an underline.
- NOTE:** If no source is active, data field cursor appears under SOURCE 1. Source 1 refers to AF Generator 1, Source 2 refers to AF Generator 2, Source 3 refers to Signaling Formats, Ext refers to signals received at EXT MOD IN Connector (17) and Mic refers to signals received at MIC/ACC Connector (18).
13. Move cursor to DEV or MOD (39) and press ENTER Key to access its data field. Use DATA ENTRY Keypad (29) to enter digits of desired modulation level and press ENTER Key.
14. If Source 1 or 2 is the last selected Source:
- Move cursor to AF FREQ (34) and press ENTER Key to access its data field. Use DATA ENTRY Keypad (29) to enter desired frequency and press ENTER Key.
  - Move cursor to WAVE (35) and press ENTER Key to access its data field. Press DATA SCROLL ↑ or ↓ Keys (3) until desired selection appears in data field and press ENTER Key.
15. If Source 3 is not the last selected source, proceed with Step 26. If Source 3 is the last selected source, Operation Screen appears as follows:

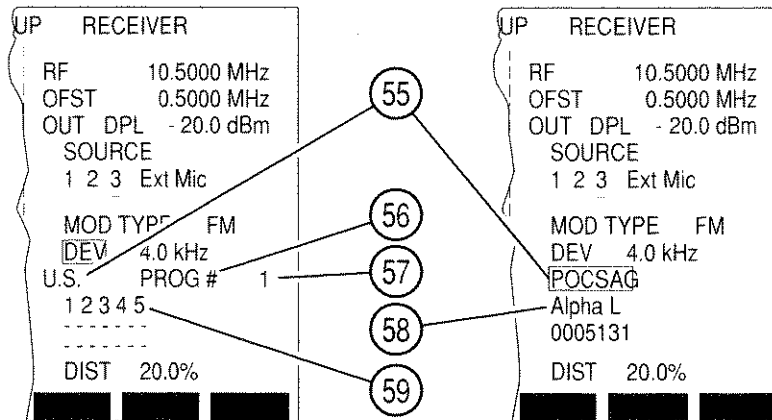

8617115

16. If DTMF is the selected Signaling Format:
- Move cursor to DIRECT ENTRY/PROG # (56). Press ENTER Key to toggle between Direct Entry and Program features.
  - If PROG is selected, move cursor to Program Number (57) and use DATA ENTRY Keypad (29) to select a programmed sequence. Press ENTER Key.
  - If DIRECT ENTRY is selected, move cursor to sequence (59) and use DATA ENTRY Keypad (29) to enter desired sequence. Press ENTER Key.

17. If DTMF is not the selected Signaling Format, move cursor to Signaling Code (55) and use DATA SCROLL ↑ and ↓ Keys (3) to select a Signaling Code from current Signaling Format. Press ENTER Key.
  - If POCSAG or Tone Remote is selected as the Signaling Code, move cursor to POCSAG or Tone Remote Function Callout (58). Use DATA SCROLL ↑ and ↓ Keys (3) to select a function and press ENTER Key.
  - If DTMF, POCSAG or Tone Remote is not selected as the Signaling Code:
    - Move cursor to DIRECT ENTRY/PROG # (56). Press ENTER Key to toggle between Direct Entry and Program features.
    - If PROG is selected, move cursor to Program Number (57) and use DATA ENTRY Keypad (29) to select a programmed sequence. Press ENTER Key.
    - If DIRECT ENTRY is selected, move cursor to sequence (59) and use DATA ENTRY Keypad (29) to enter desired sequence. Press ENTER Key.
18. To continuously generate Code, press GO TEST CONTROL Key (28). To generate Code one sequence at a time, press SGL STEP TEST CONTROL Key (28). To stop generating Code, press STOP TEST CONTROL Key (28).
19. To select a different Signaling Format, press SETUP Key to display Duplex Receiver Menu. Press 3 DATA ENTRY Key (29) to display Signaling Format Menu.

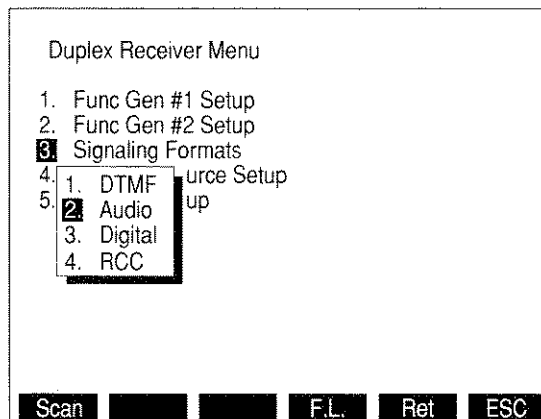

8610356

20. Use DATA ENTRY Keys (29) to select a Signaling Format and press "Ret" Soft Function Key F5.
21. To program a Signaling Code sequence, press SETUP Key to display Duplex Receiver Menu. Press 3 DATA ENTRY Key (29) to display the Signaling Formats Menu. Use DATA ENTRY Keys (29) to select a Signaling Format.

22. If DTMF is selected, DTMF Signaling Menu appears:

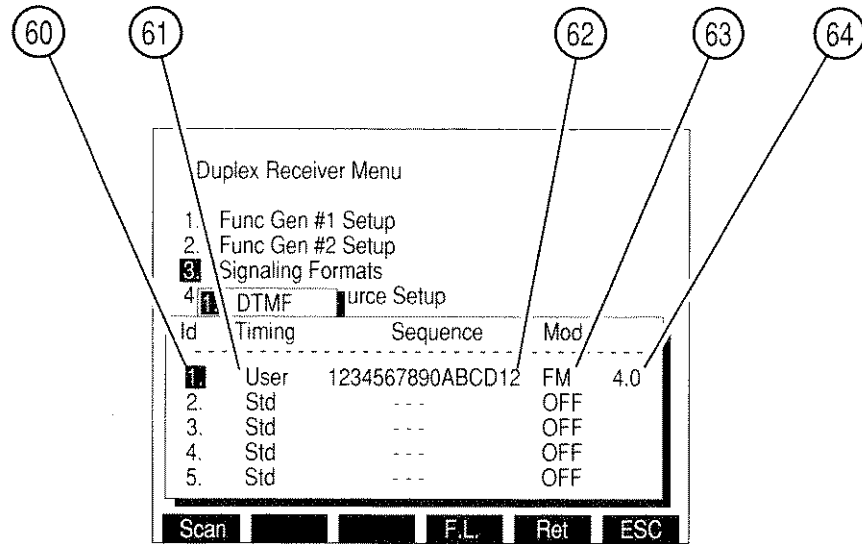

8607319

- Select Id (60) of Sequence to be edited using FIELD SELECT ↑ and ↓ Keys (1).
- Move cursor to Timing column (61) and use DATA SCROLL ↑ and ↓ Keys (3) to select Std (Standard) or User. Press ENTER Key.
- If User is chosen, data fields appear for Mark Timing and Space Timing.
  - Press 1 DATA ENTRY Key (29) and use DATA ENTRY Keypad (29) to enter Mark Timing. Press ENTER Key.
  - Press 2 DATA ENTRY Key (29) and use DATA ENTRY Keypad (29) to enter Space Timing. Press ENTER Key.
  - Press "ESC" Soft Function Key F6.
- Move cursor to Sequence column (62), enter a sequence using DATA ENTRY Keypad (29) and press ENTER Key.
 

**NOTE:** Pressing SHIFT Key toggles DATA ENTRY Keypad (29) between numeric and alphabetic characters.
- Move cursor to Mod column (63), use DATA SCROLL ↑ and ↓ Keys (3) to select Modulation Type and press ENTER Key.
- Move cursor to Mod Level (64), use DATA ENTRY Keypad (29) to select Modulation Level and press ENTER Key.
- When desired sequences are entered, press "Ret" Soft Function Key F5 to return to Duplex Operation Screen.

23. If Audio is selected as the Signaling Format, Audio Code Menu appears:

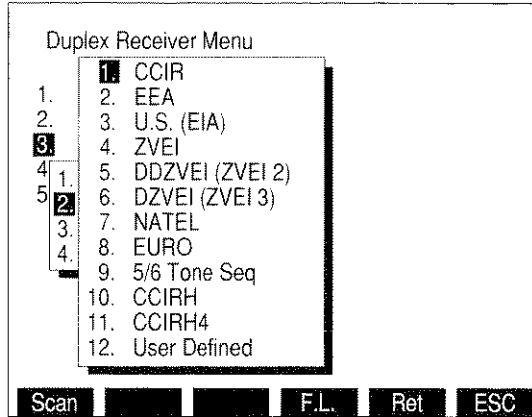

8610357

- Use FIELD SELECT Keys (1) to select an Audio Code and press ENTER Key. Audio Code Sequence Menu appears:

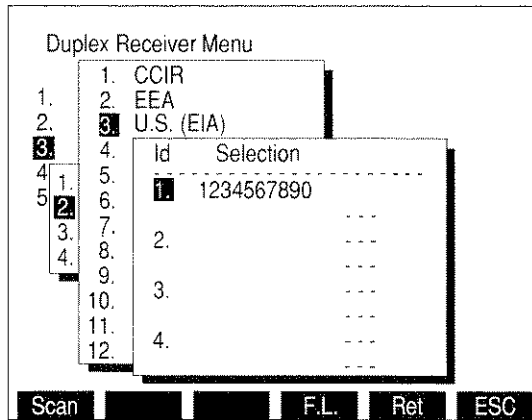

8610358

- Use FIELD SELECT Keys (1) to select an Id and press ENTER Key. Use DATA ENTRY Keys (29) to enter a sequence and press ENTER Key.

**NOTE:** Pressing SHIFT Key toggles DATA ENTRY Keypad (29) between numeric and alphabetic characters.

- If "12. User Defined" is selected as Audio Code, Audio Code User Defined Menu appears:

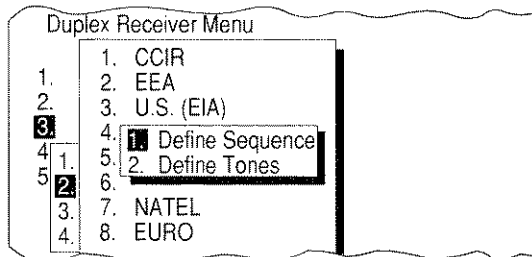

8610170

- Press 2 DATA ENTRY Key (29) to display following menu:

Duplex Receiver Menu

1. CCIF  
2. EEA  
3. U.S. (EIA)  
4. [ ]  
5. [ ]  
6. [ ]  
7. [ ]  
8. [ ]  
9. [ ]  
10. [ ]  
11. [ ]  
12. [ ]

Id	Tone(Hz)	Duration (ms)
0	5.0	20
1	10.0	20
2	20.0	20
3	30.0	20
4	40.0	20
5	50.0	20
6	60.0	20
7	70.0	20

Scan      Fill      Ret      ESC

8607320

- Move cursor to Tone(Hz) column (66) of desired Id (65) and use DATA ENTRY Keypad (29) to select frequency. Press ENTER Key.
- Move cursor to Duration(ms) column (67) and use DATA ENTRY Keypad (29) to select duration. Press ENTER Key.
- While cursor is in Tone(Hz) (66) or Duration(ms) columns (67), press "Fill" Soft Function Key F4 to fill column below cursor with value highlighted by cursor.
- When all desired tones are defined, press "ESC" Soft Function Key F6 to return to Audio Code User Defined Menu.
- Press 1 DATA ENTRY Key (29) to access Audio Code Sequence Menu. User Defined Sequences are selected as other Audio Code Sequences. When all desired sequences have been entered, press "Ret" Soft Function Key F5 to return to Duplex Operation Screen.



24. If Digital is selected as Signaling Format, Digital Code Menu appears. Use DATA ENTRY Keypad (29) to select a Digital Code.

- If DCS or DCS INV is selected as Digital Code, the DCS Code Menu appears:

Duplex Receiver Menu		
1.	Func Gen	Id Code
2.	Func Gen	1. 465
3.	Signaling	2. 000
4.	1. DTMF	3. 000
5.	2. Audio	4. 000
	3. Digital	5. 000
	4. 1. DCS	6. 000
	2. DCS	7. 000
	3. POC	8. 000

Scan F.L. Ret ESC

8610362

- Use FIELD SELECT Keys (1) to select an Id and press ENTER Key.
- Use DATA ENTRY Keypad (29) to enter a sequence and press ENTER Key. When all desired sequences have been entered, press "Ret" Soft Function Key F5 to return to Duplex Operation Screen.
- If POCSAG is selected as the Digital Code, POCSAG Menu appears:

Duplex Receiver Menu		
1.	Func Gen #1 Setup	
2.	Func Gen #2 Setup	
3.	Signaling Formats	
4.	1. DTMF	Source Setup
5.	2. Audio	1. First Capcode 5130
	3. Digital	2. Last Capcode 5135
	4. 1. DC	3. Transmit rate 512 Baud
	2. DC	4. Function Alpha special
	3. POCSAG	

Scan F.L. Ret ESC

8616008

- Press 1 DATA ENTRY Key (29) to access First Capcode. Use DATA ENTRY Keypad (29) to enter Starting Capcode and press ENTER.
- Press 2 DATA ENTRY Key (29) to access Last Capcode. Use DATA ENTRY Keypad (29) to enter Ending Capcode and press ENTER.
- Press 3 DATA ENTRY Key (29) to display the Transmit rate submenu. Choose 512 Baud or 1200 Baud.

- Press 4 DATA ENTRY Key (29) to display POCSAG Function Menu:

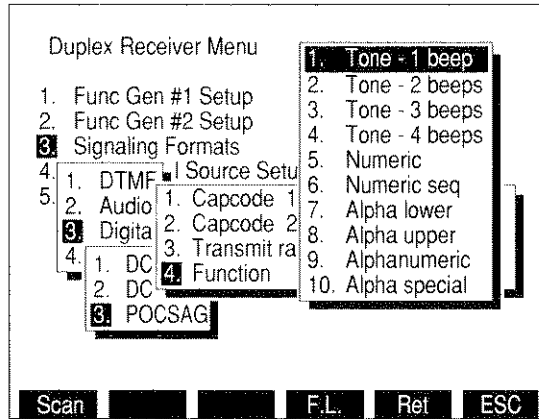

8610370

- Use FIELD SELECT Keys (1) to select a Function Type and press ENTER Key. Press "Ret" Soft Function Key F5 to return to the Duplex Operation Screen.
25. If RCC is selected as the Signaling Format, RCC Code Menu appears. Use DATA ENTRY Keypad (29) to select a RCC Code.

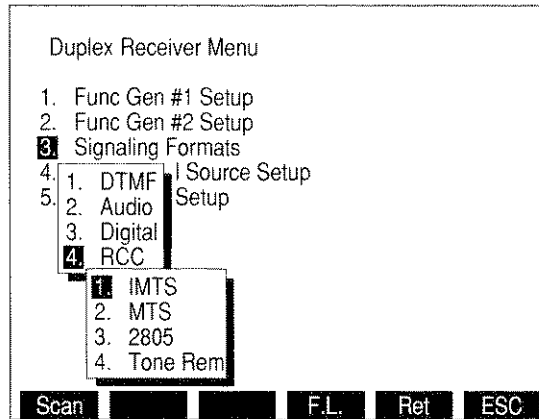

8610363

- If IMTS, MTS or 2805 is selected, RCC Sequence Menu appears:

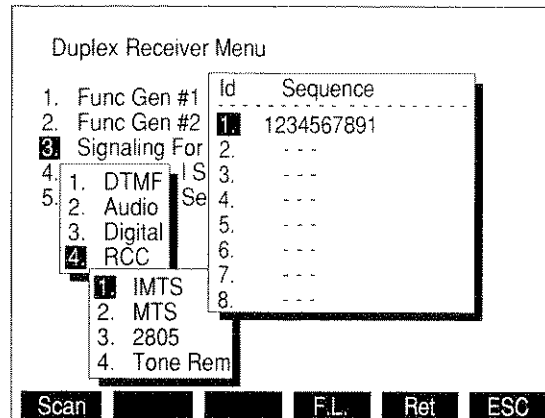

8610364

- Use FIELD SELECT Keys (1) to select an Id and press ENTER Key.
- Use DATA ENTRY Keypad (29) to enter a sequence and press ENTER Key.
- When 2805 is chosen, "Tone" Soft Function Key F3 appears. To edit 2805's audio frequency, press "Tone" Soft Function Key F3 and use DATA ENTRY Keypad (29) to enter frequency. Press ENTER Key.
- When all desired sequences have been entered, press "Ret" Soft Function Key F5 to return to Duplex Operation Screen.
- If Tone Rem is selected, Tone Remote Function Menu appears:

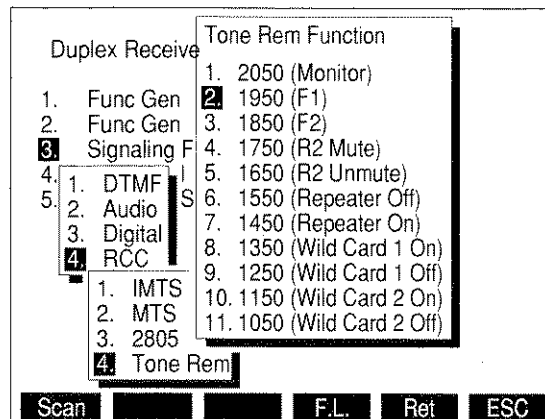

8610371

- Use FIELD SELECT Keys (1) to select a Tone Remote Function and press ENTER Key.
- Press "Ret" Soft Function Key F5 to return to Duplex Operation Screen.

26. If Modulation Source routing to AUDIO OUT Connector (14) or DEMOD OUT Connector (12) is desired or if Speaker use is desired, press SETUP Key to display the Duplex Receiver Menu. Press 5 DATA ENTRY Key (29) to access Duplex Receiver Setup Menu.

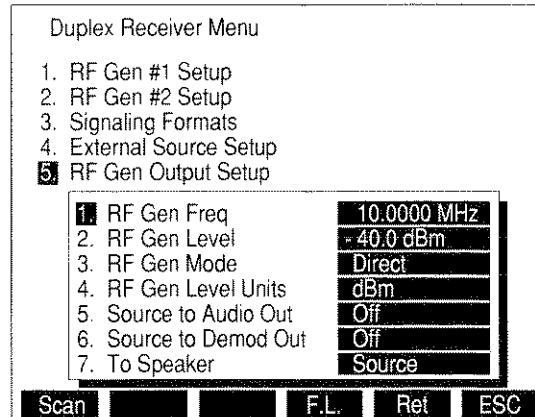

03416119

- Press 5 DATA ENTRY Key (29) as needed to enable or disable Modulation Source routing to AUDIO OUT Connector (14).
- Press 6 DATA ENTRY Key (29) as needed to enable or disable Modulation Source routing to DEMOD OUT Connector (12).
- Press 7 DATA ENTRY Key (29) and use DATA ENTRY Keypad (29) to select a signal to be routed to Speaker.

**NOTE:** Routing Source to Speaker disables SINAD and Distortion Meters.

- Press "Ret" Soft Function Key F5 to return to Duplex Operation Screen.

27. To display SINAD or Distortion Meter, press Soft Function Key F3 until desired meter (37) appears. To access a meters Operation Screen, move cursor to Meters Callout and press ENTER Key.

- For SINAD Meter Operation Procedures, see 4-8-7.
- For Distortion Meter Operation Procedures, see 4-8-6.

**NOTE:** SINAD and Distortion Meters measure SINAD/BER IN Connector (15) Input.

### Direct Mode

28. To operate the Duplex Operation with the Duplex Transmitter and/or Duplex Receiver Operation Screens in the Direct Mode, refer to Direct Mode in 4-4-4 or 4-4-5.

### Channel Mode

29. To operate the Duplex Operation with the Duplex Transmitter and/or Duplex Receiver Operation Screen in the Channel Mode, refer to Channel Mode in 4-4-4 or 4-4-5.

- To select Individual channels, move cursor to CH # and press ENTER Key to activate data field. Use ↑ or ↓ DATA SCROLL Keys (3) to select channel.

### Frequency Scan Mode

30. To operate the Duplex Operation with the Duplex Transmitter and/or Duplex Receiver Operation Screen in the Frequency Scan Mode, refer to Frequency Scan Mode in 4-4-4 or 4-4-5.

### Frequency List Mode

31. To operate the Duplex Operation with the Duplex Transmitter and/or Duplex Receiver Operation Screen in the Frequency List Mode, refer to Frequency List Mode in 4-4-4 or 4-4-5.

### Frequency List Scan Mode

32. To operate the Duplex Operation with the Duplex Transmitter and/or Duplex Receiver Operation Screen in the Frequency List Scan Mode, refer to Frequency List Scan Mode in 4-4-4 or 4-4-5.
  - When both the Duplex Receiver and Duplex Transmitter are in Frequency List Scan, operation mode "G Lock" Soft Function Key F3 appears on the Duplex Operation Screen. Press "G Lock", Soft Function Key F3, to lock the Duplex Transmitter scan frequency to the Duplex Receiver scan frequency during Frequency List Scanning.
33. After parameters of Duplex Operation Screen are set, connect UUT to Test Set:
  - For testing using separate transmit and receive lines, apply UUT transmitter output to T/R Connector (6). Connect DUPLEX Connector (24) to RF input of UUT receiver.
  - For "off the air" Duplex testing, connect antenna to ANTENNA IN Connector (25). Connect DUPLEX Connector (24) or T/R Connector (6) to RF input of UUT receiver.

## 4-4-2 MEASURING LINEAR AMPLIFIER GAIN, COMPRESSION AND BANDWIDTH

STEP	PROCEDURE
1.	Press DPLX MODE Key (27). Duplex Operation Screen appears.
2.	Move cursor to Duplex Transmitter Frequency (51) and press 3 and 0 DATA ENTRY Keys (29) to set Duplex Transmitter Frequency to <b>30.0000 MHz</b> . Press ENTER Key.
3.	Move cursor to RF IN data field (49) and press ENTER Key until <b>T/R</b> appears.
4.	Move cursor to Input Attenuation Level (47) and press DATA SCROLL ↑ and ↓ Keys (3) until <b>0 dB</b> appears. Press ENTER Key.
5.	If "Offset" Soft Function Key F4 is displayed, press "Offset" Soft Function Key F4.
6.	Move cursor to OFST (54) and press 0 DATA ENTRY Key (29) to set Duplex Offset Frequency to <b>0.0000 MHz</b> . Press ENTER Key.
7.	Move cursor to Duplex Receiver Output Connector (31) and press ENTER Key until <b>DPL</b> appears.
8.	Move cursor to Duplex Receiver Output Level (30) and press +/-, 1 and 0 DATA ENTRY Keys (29) to set Level to <b>-10 dBm</b> . Press ENTER Key.
9.	Move cursor to PWR (45) and press ENTER Key to display Power Meter Operation Screen. <ul style="list-style-type: none"><li>● Move cursor to RANGE and press DATA SCROLL ↑ and ↓ Keys (3) until <b>Autorange</b> appears. Press ENTER Key.</li><li>● Move cursor to dBm and press ENTER Key until <b>On</b> appears.</li><li>● Press "Ret" Soft Function Key F6.</li></ul>
10.	Connect DUPLEX OUT Connector (24) to input of Linear Amplifier. Connect T/R Connector (6) to output of Linear Amplifier. Linear Amplifier Gain is the Power Meter dBm reading (45) minus Duplex Receiver Output Level (30).
11.	To test Linear Amplifier for compression, move cursor to Duplex Receiver Output Level (30) and press DATA SCROLL ← and → Keys (3) to highlight the middle digit. While pressing DATA SCROLL ↑ Key (3) to increment Linear Amplifier input 1 dBm at a time, Power Meter reading (45) also increases 1 dBm. Continue pressing DATA SCROLL ↑ Key (3) until Power Meter reading (45) fails to increase 1 dBm when Duplex Receiver Output Level increases 1 dBm. Duplex Receiver Output Level (30) reads the 1 dBm compression point of the Linear Amplifier.

## STEP

## PROCEDURE

12. To test Linear Amplifier bandwidth:

- Move cursor to Duplex Receiver Output Level (30) and press +/-, 1 and 0 DATA ENTRY Keys (29) to set Level to **-10 dBm**. Press ENTER Key. Move cursor to Duplex Transmitter Frequency (51) and press DATA SCROLL ← and → Keys (3) to highlight 1 MHz digit. Rotate DATA SCROLL Spinner (2) ccw until Power Meter dBm reading (45) decreases by 3 dBm. The Duplex Transmitter Frequency (51) displayed is the low end of the Linear amplifiers frequency span.
- Rotate DATA SCROLL Spinner (2) cw until Power Meter dBm reading (45) again decreases by 3 dBm. The Duplex Transmitter Frequency (51) displayed is the high end of the Linear amplifiers frequency span. The Linear Amplifiers bandwidth is the low end of the frequency span subtracted from the high end of the frequency span.

#### 4-4-3 MEASURING MIXER PERFORMANCE

## STEP

## PROCEDURE

1. Press SCOPE/ANLZ MODE Key (27). If Oscilloscope appears, press SCOPE/ANLZ MODE Key (27) again. Analyzer Operation Screen appears.
2. Move cursor to RF and press 8, 9, • and 3 DATA ENTRY Key (29) to set Analyzer RF Frequency to **89.3000 MHz**. Press ENTER Key.
3. Move cursor to RF IN and press ENTER Key until **T/R** appears.
4. Move cursor to RF ATTEN and press DATA SCROLL ↑ Key (3) until **0dB** appears. Press ENTER Key.
5. Move cursor to Analyzer Scale Units and press DATA SCROLL ↑ Key (3) until **dBm** appears. Press ENTER Key.
6. Connect T/R Connector (6) to 1st LO Input of mixer. Verify signal is 89.3 MHz and above 0 dBm.
7. Disconnect coaxial cable and press DPLX MODE Key (27). Duplex Operation Screen appears.
8. Move cursor to Duplex Transmitter Frequency (51) and press 1, 0, • and 7 DATA ENTRY Keys (29) to set Duplex Transmitter Frequency to **10.7000 MHz**. Press ENTER Key.
9. Move cursor to RF IN data field (49) and press ENTER Key until **ANT** appears.
10. Move cursor to Duplex Transmitter Input Attenuation Level (47) and press DATA SCROLL ↑ Key (3) until **0dB** appears. Press ENTER Key.
11. If OFST (54) appears in red, press "Offset" Soft Function Key F4. Move cursor to OFST (54) and press 0 DATA ENTRY Key (29) to set Duplex Offset Frequency to **0.0000 MHz**. Press ENTER Key.
12. Move cursor to OUT data field (31) and press ENTER Key until **DPL** appears.

## STEP

## PROCEDURE

13. If a Modulation Source is active, move cursor to SOURCE (32) and press DATA SCROLL ← and → Keys (3) until an active source is highlighted. Press DATA SCROLL ↑ Key (3) until **OFF** appears for MOD TYPE (33) and press ENTER Key. Repeat process until all Modulation Sources are off.
14. Connect coaxial cable between ANTENNA IN Connector (25) and DUPLEX OUT Connector (24).
15. Move cursor to Duplex Receiver Output Level (30) and rotate DATA SCROLL Spinner (2) until Signal Strength Meter (45) reads 90. Record Duplex Receiver Output Level (30) as the reference level.
16. Move cursor to OFST (54) and press 8, 9, • and 3 DATA ENTRY Keys (29) to set Duplex Offset Frequency to **89.3000 MHz**. Press ENTER Key.
17. Connect DUPLEX OUT Connect (24) to Mixer Antenna Input. Connect ANTENNA IN Connector (25) to Mixer Output.
18. Move cursor to Duplex Receiver Output Level (30) and rotate DATA SCROLL Spinner (2) until Signal Strength Meter (45) reads 90. Duplex Receiver Output Level (30) reading minus the reference level is the mixer's loss.



#### 4-4-4 DUPLEX TRANSMITTER OPERATION

Low-power (-65 to 0 dBm) RF signals are monitored "off the air" from ANTENNA IN Connector (25) or high-power RF signals (-5 to +47 dBm) are monitored through T/R Connector (6).

**CAUTION:** MAXIMUM CONTINUOUS INPUT TO ANTENNA IN CONNECTOR (25) IS LIMITED TO 10 W.

MAXIMUM CONTINUOUS INPUT TO T/R CONNECTOR (6) IS LIMITED TO 50 W.

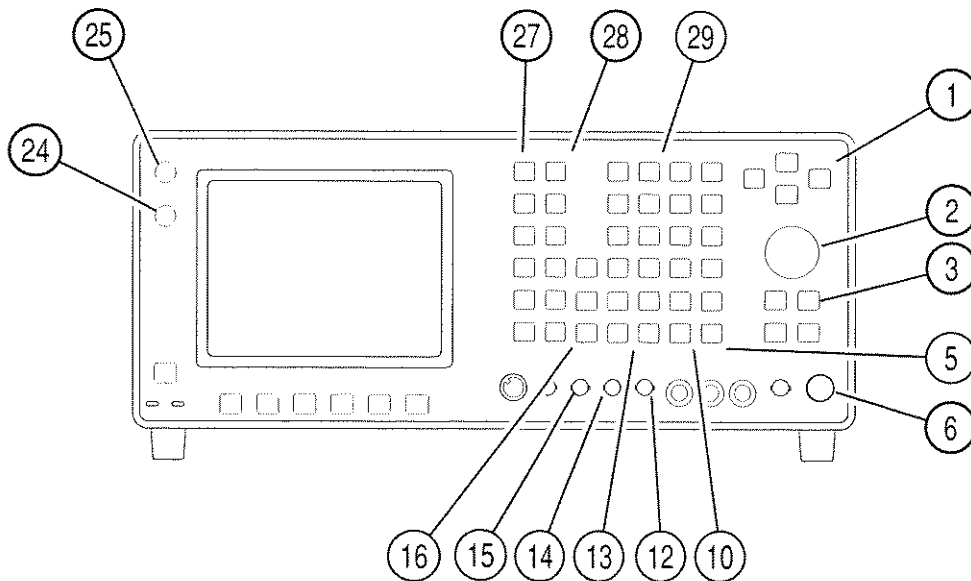

03407011

1. Press DPLX MODE Key (27). Duplex Operation Screen appears. Press "TX" Soft Function Key F1 and Duplex Transmitter Operation Screen appears.

**NOTE:** Duplex Transmitter tests Transmitting UUTs and functions as a Receiver.

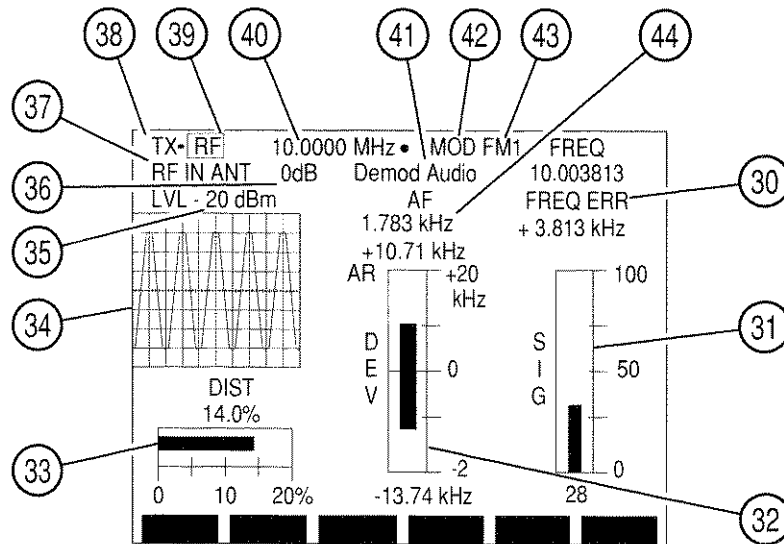

8607321

## STEP

## PROCEDURE

2. Move cursor to RF IN (37) and press ENTER Key to toggle RF Input location between "ANT" and "T/R" to match input location of received signal.
3. Move cursor to RF (39) and press ENTER Key to access data field (40). Use DATA ENTRY Keypad (29) to enter desired setting in MHz and press ENTER Key.  
**NOTE:** RF Frequency Error Meter may provide inaccurate results when Deviation Meter readings exceed Deviation Meter Range.
4. To adjust squelch level, press a SQLCH Key (10). Squelch data field appears on color display. Press SQLCH Keys (10) to adjust Squelch and press ENTER Key.
5. To adjust volume, press a VOL Key (5). Volume data field appears on color display. Press VOL Keys (5) to adjust Volume and press ENTER Key.
6. Move cursor to Input Attenuation Level (35) and press ENTER Key to access the data field. LVL appears in top right corner of the Operation Screen when Oscilloscope/Analyzer is full size. Use DATA ENTRY Keypad (29) to enter desired level and press ENTER Key.
7. Move cursor to MOD (42) and press ENTER Key to access Modulation Type data field (43). Use DATA SCROLL ↑ or ↓ Keys (3) until desired setting appears in data field and press ENTER Key. See Table 3-2 for description of modulation types.
8. If User is selected for Modulation Type, press SETUP Key to access Duplex Transmitter Menu. Press 2 DATA ENTRY Key (29) to display Duplex Transmitter Modulation Menu and press ENTER Key. User Defined Modulation Menu appears:

Duplex Transmitter Menu	
1. Set Rcvr Freq	200.0000MHz
2. Select Mod	User Defined
3.	
1. Modulation	FM DATA
2. IF Filters	3 KHz
3. Post Detection	All Pass
6.	
7. Rcvr Out Audio Out	Off
8. Rcvr Out Demod Out	On
9. Auto Volume Level	Off
10. Operation Mode	Freq Scan
11. Signaling Formats	DTMF
Scan    F.L.    Ret    ESC	

8610351.

- Press 1 DATA ENTRY Key (29) and use DATA ENTRY Keypad (29) to select User Modulation Type.
- Press 2 DATA ENTRY Key (29) and use DATA ENTRY Keypad (29) to select an IF Filter.
- Press 3 DATA ENTRY Key (29) and use DATA ENTRY Keypad (29) to select a Post Detection Filter. If Low Pass, High Pass or Band Pass is selected, a cutoff frequency data field appears. Use DATA ENTRY Keypad (29) to enter cutoff frequencies and press ENTER Key.
- Press "Ret" Soft Function Key F5 to return to Duplex Transmitter Operation Screen.

STEP

PROCEDURE

9. If decoding Signaling Formats is not desired, proceed with Step 17.
10. Press SETUP Key to display Duplex Transmitter Menu and move cursor to "11. Signaling Formats" and press ENTER Key. Use DATA ENTRY Keypad (29) to select a Signaling Format.
  - If DTMF is selected, press "Ret" Soft Function Key F5 to return to Duplex Transmitter Operation Screen.
  - If Audio is selected, Audio Code Menu appears. Use FIELD SELECT Keys (1) to select an Audio Code and press ENTER Key. Press "Ret" Soft Function Key F5 to return to Duplex Transmitter Operation Screen.

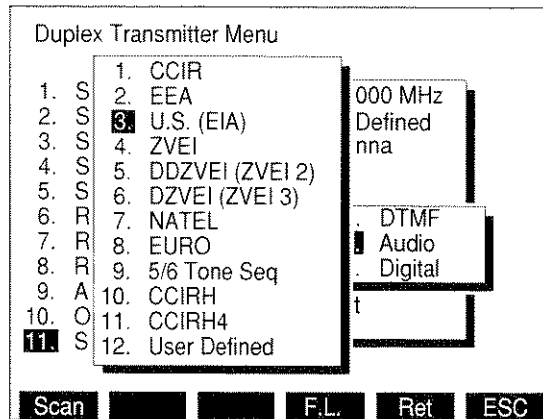

8610353

- If Digital is selected, Digital Code Menu appears. Use DATA ENTRY Keys (29) to select a Digital Code. Press "Ret" Soft Function Key F5 to return to Duplex Transmitter Operation Screen.
11. Press "More" Soft Function Key F6 until "Disp" Soft Function Key F1 is displayed. Press "Disp" Soft Function Key F1 to display following submenu:

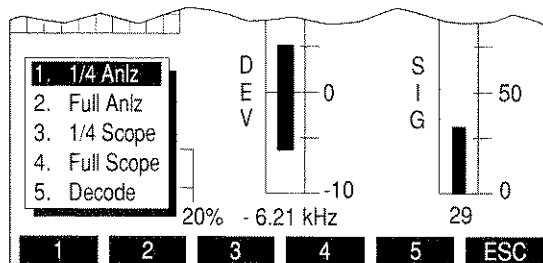

8617081

12. Press 5 DATA ENTRY Key (29) to display Decode Callout (46).

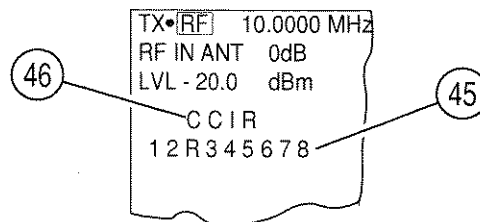

8617116

13. For DTMF Decode, press "Decode" Soft Function Key F2. Decoded digits (45) are displayed under DTMF Callout. To stop decoding, press "Stop" Soft Function Key F3.
14. For DCS or DCS INV Decode:
  - To change Input Source, press "Input" Soft Function Key F5. A submenu appears listing Input Sources. Use DATA ENTRY Keypad (29) to select an Input Source.  
**NOTE:** Source "2. SIN/BER (INV)" inverts Input before decoding.
  - Press "Decode" Soft Function Key F2. Decoded digits (45) are displayed under Decode Callout (46). To stop decoding, press "Stop" Soft Function Key F3.
15. For Audio Decode, press "Extend" Soft Function Key F5 to display following screen:

Audio Tones Decode: CCIR							
#	Frq	Err %	Dur	#	Frq	Err %	Dur
1	1158	3.2	98				
2	1167	2.5	99				
3	1298	1.8	101				
4	1406	3.5	98				
5	1475	2.0	98				

8610175

- To change Input Source, press "Input" Soft Function Key F1. A submenu appears listing Input Sources. Use DATA ENTRY Keypad (29) to select an Input Source.
- Press "Type" Soft Function Key F4 to select Audio Code. Use DATA SCROLL ↑ and ↓ Keys (3) to select an Audio Code and press ENTER Key.
- Press "Decode" Soft Function Key F2 to decode. Decoded digits, frequencies, frequency error percentages and time durations are displayed.
- Press "Stop" Soft Function Key F3 to stop decoding. Press "Ret" Soft Function Key F5 to return to Duplex Transmitter Operation Screen.

16. For POCSAG Decode, press "Extend" Soft Function Key F5 to display following screen:

```

POCSAG Decode : 512 Baud
Capcode : 0005130   TYPE : NUMERIC
Msg : 316 - 555 - 4437
Capcode : 0005140   TYPE : NUMERIC
Msg : 316 - 555 - 9746
Capcode : 0005145   TYPE : NUMERIC

```

Input Decode Stop Rate Auto Cl Ret

8610369

- To change Input Source, press "Input" Soft Function Key F1. A submenu appears listing Input Sources. Use DATA ENTRY Keypad (29) to select an Input Source.
  - Press "Rate" Soft Function Key F4 to toggle POCSAG Rate to 512 Baud or 1200 Baud.
  - Press "Decode" Soft Function Key F2 to decode. POCSAG Capcode, type and message are displayed.
  - To enable automatic screen clear, press "Auto Cl" Soft Function Key F5 until "Auto Cl" appears in red. When enabled, clears full screen when next POCSAG word is received.
  - Press "Stop" Soft Function Key F3 to stop decoding. Press "Ret" Soft Function Key F6 to return to Duplex Transmitter Operation Screen.
17. To set Duplex Transmitter Output parameters, press SETUP Key to display Duplex Transmitter Menu.
- Press 5 DATA ENTRY Key (29) to display AGC Type Menu. Use DATA ENTRY Keypad (29) to select an AGC Type.
    - If User Defined is selected as AGC Type, User Defined AGC Type Menu appears. Use DATA ENTRY Keypad (29) to select an User Defined AGC Type.
    - If Manual is selected, a data field appears. Use DATA ENTRY Keypad (29) to enter an AGC Level and press ENTER Key.
  - To route demodulated received signal to Speaker, press 6 DATA ENTRY Key (29) to toggle "Rcvr Out Speaker" on.
  - To route demodulated received signal to AUDIO OUT Connector (14), press 7 DATA ENTRY Key (29) to toggle "Rcvr Out Audio Out" on.
  - To route demodulated Received Signal to DEMOD Connector (12), press 8 DATA ENTRY Key (29) to toggle "Rcvr Out Demod Out" on.

- Press 9 DATA ENTRY Key (29) to toggle "Auto Volume Level" on or off.
- Press "Ret" Soft Function Key F5 to return to Duplex Transmitter Operation Screen.

18. If an Oscilloscope or Analyzer Display is not desired, proceed with Step 23.
19. Press "More" Soft Function Key F6 until "Disp" Soft Function Key F1 appears. Press "Disp" Soft Function Key F1 to display a menu listing Oscilloscope and Analyzer options. Use DATA ENTRY Keypad (29) to select an option.

**NOTE:** 1/4 size Analyzer Screen parameters are edited by first selecting full size Analyzer Screen, changing parameters, and then reselecting 1/4 size Analyzer Screen.

20. If "2. Full Anlz" is selected:

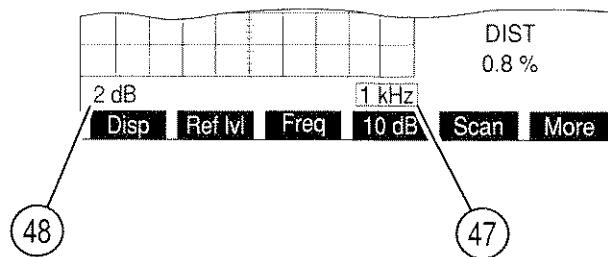

8607322

- Move cursor to Analyzer Scan Width (47) and press ENTER Key to access the data field. Press DATA SCROLL ↑ or ↓ Keys (3) until desired selection appears in data field and press ENTER Key to activate Scan Width desired.
- Move cursor to Analyzer Scale (48) and press ENTER Key to toggle Analyzer Scale between 2 and 10 dB.
- If 2 dB is selected for Analyzer Scale, press "Ref lvl" Soft Function Key F2 and use DATA SCROLL Spinner (2) or DATA SCROLL ↑ and ↓ Keys (3) to adjust Reference Level. Press ENTER Key.

21. If "3. 1/4 Scope" is selected:

- Move cursor to Oscilloscope Input (41) and press ENTER Key to access the data field. Press DATA SCROLL ↑ or ↓ Keys (3) until desired selection appears in data field and press ENTER Key to activate.

**NOTE:** The remaining Oscilloscope parameters are edited by selecting full size Scope display, editing desired parameters and reselecting 1/4 size Scope display.

22. If "4. Full Scope" is selected:

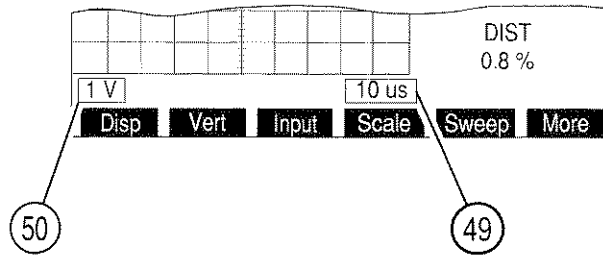

8607110

- Move cursor to Oscilloscope Input (41) and press ENTER Key to access the data field. Press DATA SCROLL ↑ or ↓ Keys (3) until desired selection appears in data field and press ENTER Key to activate.
  - If needed, move cursor to Oscilloscope Sweep Rate (49) and press ENTER Key to access the data field. Press DATA SCROLL ↑ or ↓ Keys (3) until desired selection appears in data field and press ENTER Key to activate.
  - Move cursor to Oscilloscope Scale (50) and press ENTER Key to access the data field. Press DATA SCROLL ↑ or ↓ Keys (3) until desired selection appears in data field and press ENTER Key to activate.
  - If needed, press "Vert" Soft Function Key F2 to edit vertical adjustment of Oscilloscope Trace. Use DATA SCROLL Spinner (2) or DATA SCROLL ↑ or ↓ Keys (3) to adjust vertical position of Oscilloscope Trace.
23. To select a meter, press "More" Soft Function Key F6 until "AUX" Soft Function Key F5 appears:
- For FM Modulation, press "Meters" Soft Function Key F4 to select SINAD, Distortion or Deviation (RMS) Meter.
  - For PM Modulation, press "Meters" Soft Function Key F4 to select SINAD, Distortion or Phase (RMS) Meter.
  - For AM Modulation, press "Modul"/"Dist" Soft Function Key F4 to select Modulation or Distortion Meter. Both Meters are displayed, but only selected meter is functional.
  - For USB, LSB or BFO Modulation, press "Tune" Soft Function Key F4 and use DATA SCROLL ↑ and ↓ Keys (3) to tune Receiver in 125 Hz steps. Press ENTER Key.
24. To zero Deviation Meter if displayed, press "More" Soft Function Key F6 until "FM Z" Soft Function Key F3 appears. Press "FM Z" Soft Function Key F3. To abort zeroing process, press Soft Function Key F3 before "FM Z" reappears.

- 
25. To edit a Meters settings, move cursor to Callout of Meter to be edited and press ENTER Key. Meter Operation Screen appears.
- For RF Frequency Error Meter Operation Procedures, see 4-8-2.
  - For AF Meter Operation Procedures, see 4-8-1.
  - For FM Deviation (Peak) Meter Operation Procedures, see 4-8-4.
  - For Phase Meter Operation Procedures, see 4-8-11.
  - For AM Modulation Meter Operation Procedures, see 4-8-5.
  - For Distortion Meter Operation Procedures, see 4-8-6.
  - For Power Meter Operation Procedures, see 4-8-3.
  - For Signal Strength Meter Operation Procedures, see 4-8-8.
  - For SINAD Meter Operation Procedures, see 4-8-7.
  - For Deviation (RMS) Meter Operation Procedures, see 4-8-12.
  - For Phase (RMS) Meter Operation Procedures, see 4-8-13.
26. To operate Find Function:
- Press "More" Soft Function Key F6 until "Disp" Soft Function Key F1 appears. Press "Disp" Soft Function Key F1 to display a menu listing Oscilloscope and Analyzer options.
  - Press 2 DATA ENTRY Key (29) to select full size Analyzer display.
  - Press "More" Soft Function Key F6 and press "Find lvl" Soft Function Key F2. Find Level is indicated by a red horizontal line. Use DATA SCROLL Spinner (2) or DATA SCROLL ↑ and ↓ Keys (3) to adjust Find Level and press ENTER Key.
  - Press "Find" Soft Function Key F1 to activate Find Function. Duplex Transmitter Frequency (39) changes to frequency found.

### Channel Mode

27. To operate Duplex Transmitter in Channel Mode, press SETUP Key to display Duplex Transmitter Menu.
- Move cursor to "10. Operation Mode" and press ENTER Key. Press 2 DATA ENTRY Key (29) to select Duplex Transmitter Channel Mode.
  - Press "Chan" Soft Function Key F2 to display a submenu listing cellular formats. Use DATA ENTRY Keypad (29) to select a cellular format.



- Press "Ret" Soft Function Key F5 to return to Duplex Transmitter Operation Screen. Duplex Transmitter Frequency is displayed by channel number.
- See the following Appendices for listings of cellular channels and corresponding frequencies:

CHANNEL FORMAT	APPENDIX
NADC/NAMPS	B
E-TACS	C

### Direct Mode

28. To operate Duplex Transmitter in Direct Mode, press SETUP Key to display Duplex Transmitter Menu. Move cursor to "10. Operation Mode" and press ENTER Key. Press 1 DATA ENTRY Key (29) to select Duplex Transmitter Direct Mode. Press "Ret" Soft Function Key F5 to return to Duplex Transmitter Operation Screen.

### Frequency Scan Mode

29. To operate Duplex Transmitter Scan Function, press SETUP Key to display Duplex Transmitter Menu. Move cursor to "10. Operation Mode" and press ENTER Key. Press 3 DATA ENTRY Key (29) to select Duplex Transmitter Freq Scan Mode. Press "Scan" Soft Function Key F1 to display RF Frequency Scan Menu:

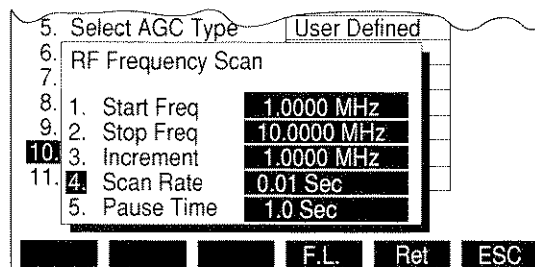

8610381

- Press 1 DATA ENTRY Key (29) and use DATA ENTRY Keypad (29) to enter Starting Frequency (Starting Frequency must be less than Ending Frequency). Press ENTER Key.
- Press 2 DATA ENTRY Key (29) and use DATA ENTRY Keypad (29) to enter Ending Frequency. Press ENTER Key.
- Press 3 DATA ENTRY Key (29) and use DATA ENTRY Keypad (29) to enter Increment. Press ENTER Key.
- Press 4 DATA ENTRY Key (29) and use DATA ENTRY Keypad (29) to enter Scan Rate. Press ENTER Key.
- Press 5 DATA ENTRY Key (29) and use DATA ENTRY Keypad (29) to enter Pause Time. Press ENTER Key. Zero Pause Time causes Duplex Transmitter Scan to remain on a frequency until squelch is no longer broken.
- Press "Ret" Soft Function Key F5 to return to Duplex Transmitter Operation Screen.

- Press GO TEST CONTROL Key (28) to start Duplex Transmitter Scan. Press STOP TEST CONTROL Key (28) to stop Scanning. Pressing GO TEST CONTROL Key (28) again resumes scanning operation. Press SGL STEP TEST CONTROL Key (28) to single step through scanning operation one increment at a time.

**NOTE:** The following steps use the Frequency List (F.L.) that is shared between the RF Generator, Receiver, Duplex, Duplex Transmitter and Duplex Receiver Operation Screens. The Frequency List can be used as a list to manually select different frequencies or as a table for scanning. When used for scanning, specific frequencies in the Frequency List must be manually toggled On or Off.

### Frequency List Mode

30. To operate Duplex Transmitter in Frequency List Mode, press SETUP Key to display the Duplex Transmitter Setup Menu. Press ↑ or ↓ FIELD SELECT Keys (1) to move cursor to "10. Operation Mode". Press ENTER Key to display the Duplex Transmitter Operation Mode Menu. Press 4 DATA ENTRY Key (29) to select Freq List. Press "F.L." Soft Function Key F4 to display the Stored RF Frequency List.
  - Press ↑ or ↓ FIELD SELECT Keys (1), in conjunction with "Pg Up" or "Pg Dn" Soft Function Keys F1 and F2, as needed, to move cursor to desired Item line in the Frequency List.
  - Press ← or → FIELD SELECT Keys (1) as needed to move cursor to select the Generate, Receive or Offset entries (Offset frequency is equal to Generate frequency minus Receive frequency). Press ENTER Key to activate the data field and use DATA ENTRY Keypad (29) to enter desired frequency. Press ENTER Key.
  - Continue selecting Item lines and entering frequency values until desired Frequency List is created.
  - Press "Clear" Soft Function Key F3 to return the frequency entry selected by the cursor to 0.2500 MHz, the lowest frequency allowable.
  - Press "Fill" Soft Function Key F4 to copy the selected frequency entry value into all entries listed below in the same column.
  - Press "Ret" Soft Function Key F5 to return to Duplex Transmitter Operation Screen.
  - Press "More" Soft Function Key F6 until "Freq" Soft Function Key F1 appears. Press "Freq" Soft Function Key F1 to activate the data field of the Frequency List Item number. Press ↑ or ↓ DATA SCROLL Keys (3) to select desired frequency. Press ENTER Key.

### Frequency List Scan Mode

31. To operate Duplex Transmitter in Frequency List Scan Mode, press SETUP Key to display the Duplex Transmitter Setup Menu. Press ↑ or ↓ FIELD SELECT Keys (1) to move cursor to "10. Operation Mode". Press ENTER Key to display the Duplex Transmitter Operation Mode Menu. Press 5 DATA ENTRY Key (29) to select Freq List Scan. Press "F.L." Soft Function Key F4 to display the Stored RF Frequency List.

**STEP****PROCEDURE**

---

- Refer to Step 30, Frequency List Mode, to create the desired listing of frequencies.
- Use the FIELD SELECT Keys (1) and the ENTER Key to toggle the Scan "switch" to 'on' or 'off' for each Item listing. Item listings that are turned off are skipped when the scan operation is activated.
- Press "Ret" Soft Function Key F5 to return to Duplex Transmitter Operation Screen.
- Press GO TEST CONTROL Key (28) to start Duplex Transmitter Scan. Press STOP TEST CONTROL Key (28) to stop Scanning. Pressing GO TEST CONTROL Key (28) again resumes scanning operation. Press SGL STEP TEST CONTROL Key (28) to single step through scanning operation one increment at a time.
- While scanning or single stepping through the Frequency List, the operation begins again at the first "turned-on" frequency listing after reaching the last frequency listing.

**NOTE:** To store or recall a set of screen parameters, see 4-1-1.

## 4-4-5 DUPLEX RECEIVER OPERATION

### STEP PROCEDURE

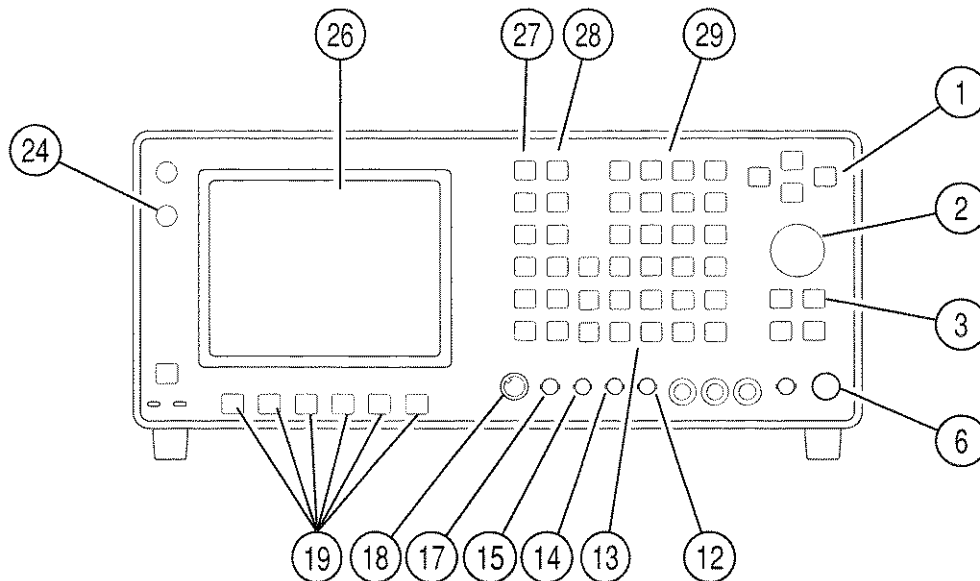

03407012

1. Press DPLX MODE Key (27) press "RX" Soft Function Key F2. Duplex Receiver Operation Screen appears.

**NOTE:** Duplex Receiver tests Receiving UUTs and functions as a RF Generator.

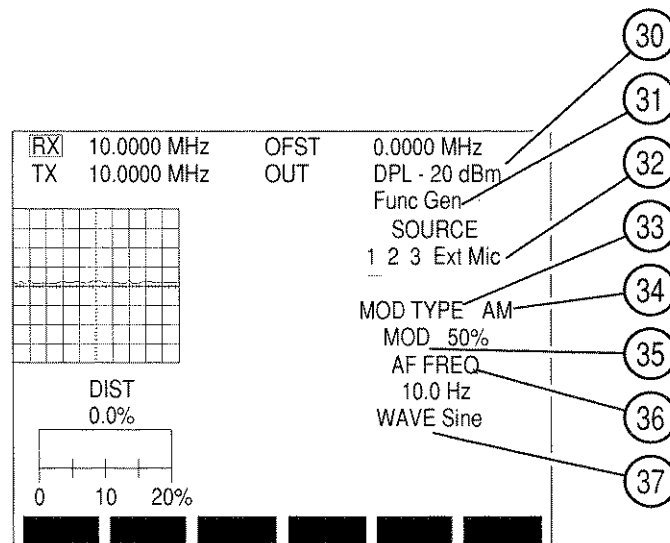

03416045

2. Press "More" Soft Function Key F6 until "Offset" or "R Freq" Soft Function Key F5 appears. Press Soft Function Key F5 to toggle which frequency is editable. Use DATA ENTRY Keypad (29) to enter desired frequency and press ENTER Key.

**NOTE:** When Duplex Offset Frequency (OFST) or Duplex Receiver Frequency (RX) is edited, the display-only frequency changes for their sum to equal the Duplex Transmitter Frequency (TX). Duplex Transmitter Frequency (TX) is display-only in this Operation Screen.

3. Move cursor to OUT and press ENTER Key to toggle Duplex Receiver Output location between "DPL" (DUPLEX OUT Connector [24]) and "T/R" (T/R Connector [6]).
4. Move cursor to Output Level (30) and press ENTER Key. Use DATA ENTRY Keypad (29) to enter desired level and press ENTER Key. If necessary, press +/- DATA ENTRY Key (29) to place "-" in data field.

**NOTE:** Duplex Receiver Output Level is limited to -20 dBm when a signal greater than 2 W is received at T/R Connector (6) and T/R Connector (6) is selected as Duplex Receiver Output Connector.

5. Move cursor to SOURCE (32) and press ENTER Key to access active Modulation Source. Use FIELD SELECT ← and → Keys (1) to place cursor over desired source and use DATA SCROLL ↑ or ↓ Keys (3) to select desired Modulation Type (34). White indicates OFF, red indicates AM, yellow indicates FM and green indicates PM. Last selected Modulation Type is displayed with MOD TYPE (33).

**NOTE:** If no source is active, data field cursor appears under SOURCE 1. If more than one source is on, last selected Source is indicated by an underline. Source 1 refers to AF Generator 1, Source 2 refers to AF Generator 2, Source 3 refers to Signaling Formats, Ext refers to signals received at EXT MOD IN Connector (17) and Mic refers to signals received at MIC/ACC Connector (18).

6. Move cursor to DEV or MOD (35) and press ENTER Key to access its data field. Use DATA ENTRY Keypad (29) to enter digits of desired deviation frequency or modulation percentage and press ENTER Key.

**NOTE:** When Ext Source is selected, Modulation Level setting assumes the modulating signal applied to the EXT MOD IN Connector (17) is 3.54 VRMS. Modulation Level setting is set higher for lower EXT MOD IN Connector (17) input voltages to achieve the same modulation level as per the following equation:

$$\begin{array}{rcccl} \text{Modulation} & & \text{EXT MOD IN} & & \text{Actual} \\ \text{Level setting} & \times & \text{Connector} & + & \text{Modulation} \\ \text{(kHz, \%, rad)} & & \text{Input (VRMS)} & & \text{Level} \\ & & & & + 3.54 = \end{array}$$

7. If Source 1 or 2 is the last selected Source:
  - Move cursor to AF FREQ (36) and press ENTER Key to access data field. Use DATA ENTRY Keypad (29) to enter desired frequency and press ENTER Key.
  - Move cursor to WAVE (37) and press ENTER Key to access data field. Press DATA SCROLL ↑ or ↓ Keys (3) until desired selection appears in data field and press ENTER Key to activate Wave Shape.

8. If Source 3 is not selected as the last selected Source, proceed with Step 19. If Source 3 is the last selected Source, the Operation Screen appears as follows:

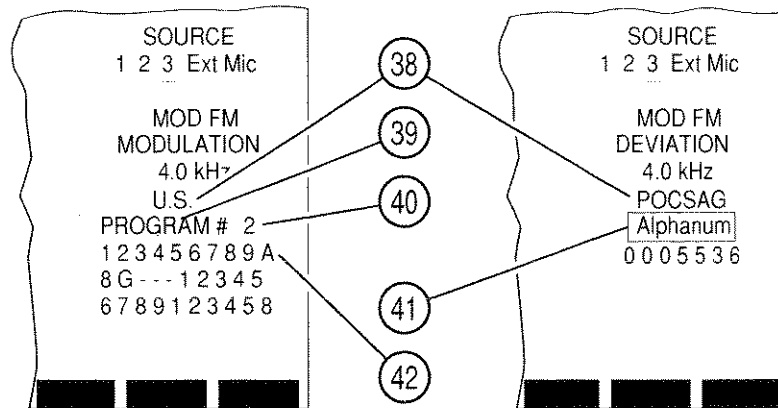

03416046

9. If DTMF is the Signaling Format:
- Move cursor to DIRECT ENTRY/PROGRAM # (39). Press ENTER Key to toggle between Direct Entry and Program features.
  - If PROGRAM is selected, move cursor to Program Number (40) and use DATA ENTRY Keypad (29) to select a programmed sequence. Press ENTER Key.
  - If DIRECT ENTRY is selected, move cursor to sequence listing (42) and use DATA ENTRY Keypad (29) to enter desired sequence. Press ENTER Key.
10. If DTMF is not Signaling Format, move cursor to Signaling Code (38) and use DATA SCROLL ↑ and ↓ Keys (3) to select one of Signaling Codes of current Signaling Format. Press ENTER Key.
- If POCSAG or Tone Remote is selected as Signaling Code, move cursor to POCSAG or Tone Remote Function Callout (50). Use DATA SCROLL ↑ and ↓ Keys (3) to select a function and press ENTER Key.

- If DTMF, POCSAG or Tone Remote is not selected as the Signaling Code, the Duplex Receiver Operation Screen appears as follows:

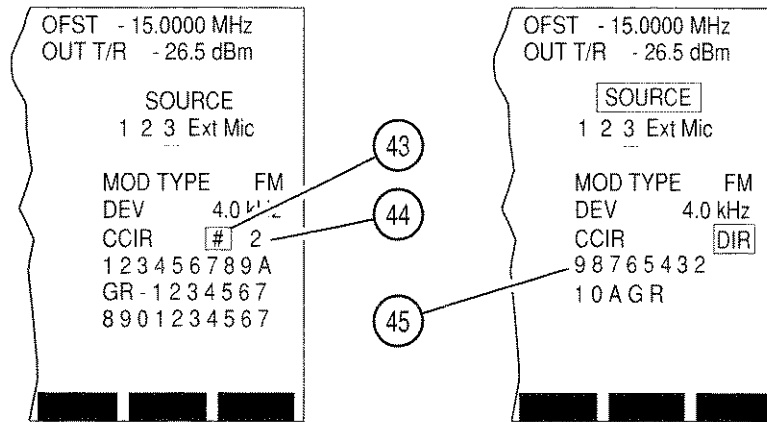

03416047

- Move cursor to DIRECT ENTRY/PROG # (43). Press ENTER Key to toggle between Direct Entry and Program features.
  - If PROG is selected, move cursor to Program Number (44) and use DATA ENTRY Keypad (29) to select a programmed sequence. Press ENTER Key.
  - If DIRECT ENTRY is selected, move cursor to sequence listing (45) and use DATA ENTRY Keypad (29) to enter desired sequence. Press ENTER Key.
11. To generate Code, press GO TEST CONTROL Key (28). To stop generating Code, press STOP TEST CONTROL Key (28). To generate Code one tone at a time, press SGL STEP TEST CONTROL Key (28).
  12. To select a different Signaling Format, press SETUP Key to display Duplex Receiver Menu. Press 3 DATA ENTRY Key (29) to display Signaling Format Menu:

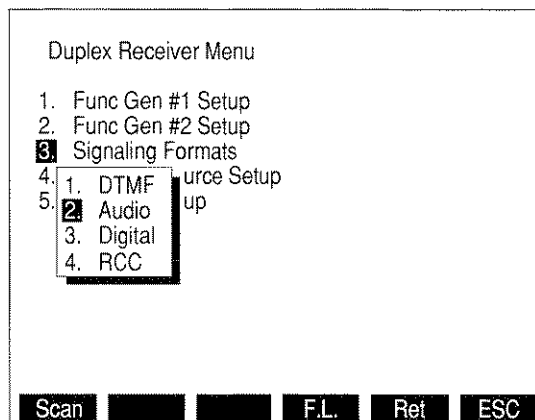

8610356

13. Use DATA ENTRY Keys (29) to select a Signaling Format and press "Ret" Soft Function Key F5.

14. To program a Signaling Code sequence, press SETUP Key to display Duplex Receiver Menu. Press 3 DATA ENTRY Key (29) to display the Signaling Formats Menu. Use DATA ENTRY Keys (29) to select a Signaling Format.
15. If DTMF is selected, DTMF Signaling Menu appears:

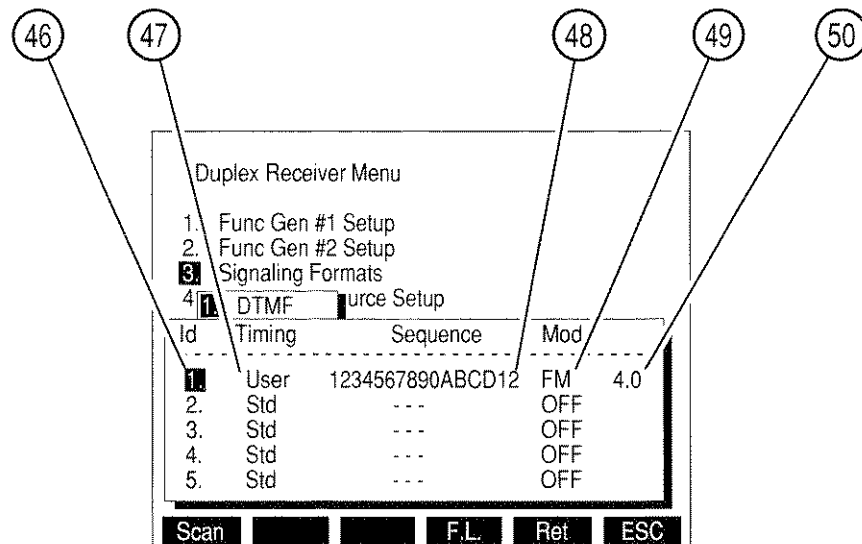

03416048

Select Id (46) of Sequence to be edited using FIELD SELECT ↑ and ↓ Keys (1).

- Move cursor to Timing column (47) and use DATA SCROLL ↑ and ↓ Keys (3) to select Std (Standard) or User. Press ENTER Key.
- If User is chosen, data fields appear for Mark Timing and Space Timing.
  - Press 1 DATA ENTRY Key (29) and use DATA ENTRY Keypad (29) to enter Mark Timing. Press ENTER Key.
  - Press 2 DATA ENTRY Key (29) and use DATA ENTRY Keypad (29) to enter Space Timing. Press ENTER Key.
  - Press "ESC" Soft Function Key F6.
- Move cursor to Sequence column (48), enter a sequence using DATA ENTRY Keypad (29) and press ENTER Key.
 

**NOTE:** Pressing SHIFT Key toggles DATA ENTRY Keypad (29) between numeric and alphabetic characters.
- Move cursor to Mod column (49), use DATA SCROLL ↑ and ↓ Keys (3) to select Modulation Type and press ENTER Key.
- Move cursor to Mod Level (50), use DATA ENTRY Keypad (29) to select Modulation Level and press ENTER Key.



- When desired sequences are entered, press ENTER Key and "Ret" Soft Function Key F5 to return to Duplex Receiver Operation Screen.

16. If Audio is selected as Signaling Format, Audio Code Menu appears:

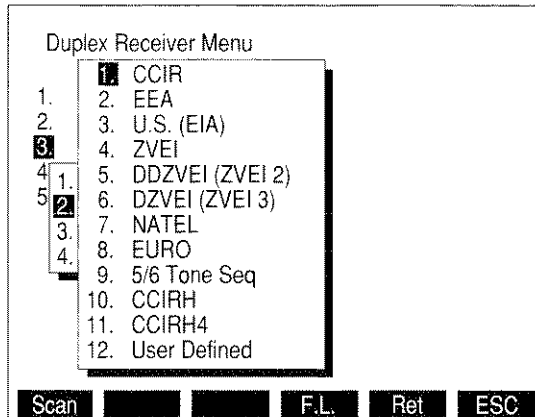

8610357

- Use FIELD SELECT Keys (1) to select an Audio Code and press ENTER Key. Audio Code Sequence Menu appears:

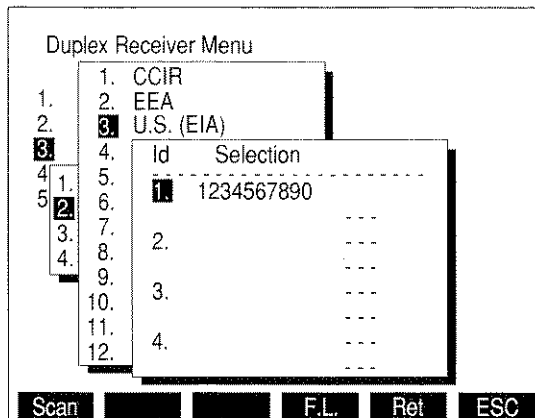

8610358

- Use FIELD SELECT Keys (1) to select an Id and press ENTER Key.
- Use DATA ENTRY Keys (29) to enter a sequence and press ENTER Key.

**NOTE:** Pressing SHIFT Key toggles DATA ENTRY Keypad (29) between numeric and alphabetic characters.

- If "12. User Defined" is selected as Audio Code, the Audio Code User Defined Menu appears:

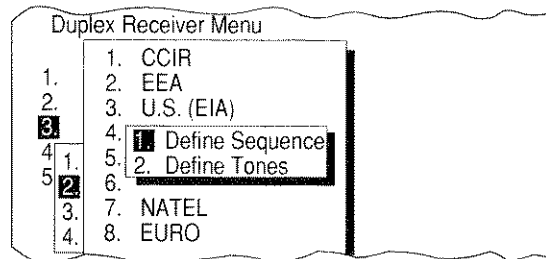

8610170

- Press 2 DATA ENTRY Key (29) to display following menu:

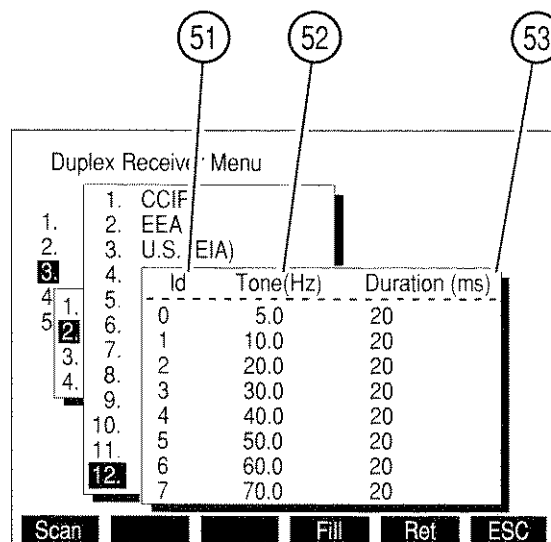

03416049

- Move cursor to Tone(Hz) column (52) of desired Id (51) and use DATA ENTRY Keypad (29) to select frequency. Press ENTER Key.
- Move cursor to Duration(ms) column (53) and use DATA ENTRY Keypad (29) to select duration. Press ENTER Key.
- When cursor is in Tone(Hz) (52) or Duration(ms) columns (53), press "Fill" Soft Function Key F4 to fill column below cursor with value highlighted by cursor.
- When all desired tones are defined, press "ESC" Soft Function Key F6 to return to Audio Code User Defined Menu.
- Press 1 DATA ENTRY Key (29) to access Audio Code Sequence Menu. User Defined Sequences are selected as other Audio Code Sequences. When all desired sequences have been entered, press "Ret" Soft Function Key F5 to return to Duplex Receiver Operation Screen.

17. If Digital is selected as the Signaling Format, Digital Code Menu appears. Use DATA ENTRY Keypad (29) to select a Digital Code.

- If DCS or DCS INV is selected as Digital Code, DCS Code Menu appears:

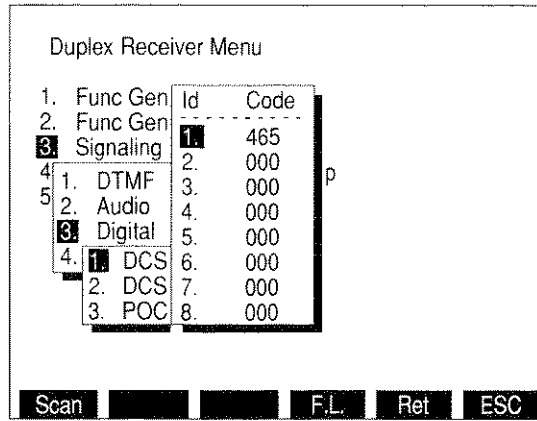

8610362

- Use FIELD SELECT Keys (1) to select an Id and press ENTER Key.
- Use DATA ENTRY Keypad (29) to enter a sequence and press ENTER Key. When all desired sequences have been entered, press "Ret" Soft Function Key F5 to return to Duplex Receiver Operation Screen.
- If POCSAG is selected as the Digital Code, POCSAG Menu appears:

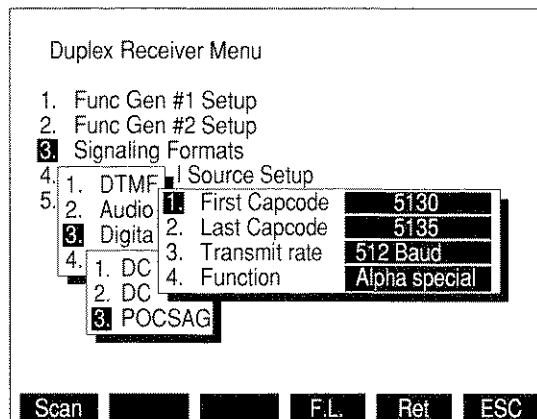

8616008

- Press 1 DATA ENTRY Key (29) to access First Capcode. Use DATA ENTRY Keypad (29) to enter Starting Capcode and press ENTER.
- Press 2 DATA ENTRY Key (29) to access Last Capcode. Use DATA ENTRY Keypad (29) to enter Ending Capcode and press ENTER.
- Press 3 DATA ENTRY Key (29) to display the Transmit rate submenu. Choose 512 Baud or 1200 Baud.

- Press 4 DATA ENTRY Key (29) to display POCSAG Function Menu:

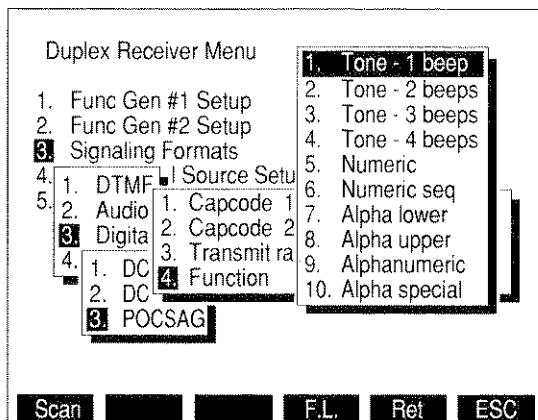

8610367

- Use FIELD SELECT Keys (1) to select a Function Type and press ENTER Key. Press "Ret" Soft Function Key F5 to return to the Duplex Receiver Operation Screen.

18. If RCC is selected as the Signaling Format, RCC Code Menu appears. Use DATA ENTRY Keypad (29) to select an RCC Code.

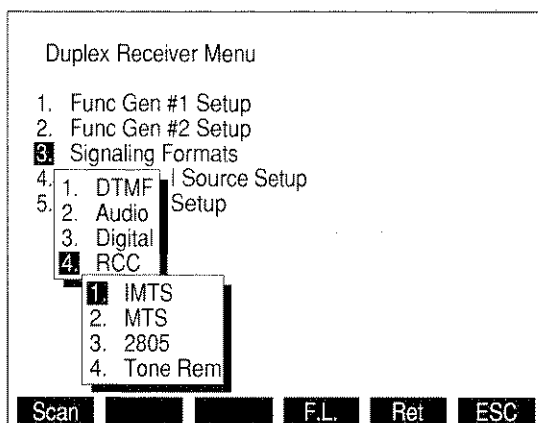

8610363

- If IMTS, MTS or 2805 is selected, RCC Sequence Menu appears:

Duplex Receiver Menu

Id	Sequence
1	1234567891
2	---
3	---
4	---
5	---
6	---
7	---
8	---

1. Func Gen #1  
2. Func Gen #2  
3. Signaling For  
4. 1. DTMF  
5. 2. Audio  
3. Digital  
4. RCC  
1. IMTS  
2. MTS  
3. 2805  
4. Tone Rem

Scan F.L. Ret ESC

8610364

- Use FIELD SELECT Keys (1) to select an Id and press ENTER Key.
- Use DATA ENTRY Keypad (29) to enter a sequence and press ENTER Key.
- When 2805 is chosen, "Tone" Soft Function Key F3 appears. To edit 2805's frequency, press "Tone" Soft Function Key F3 and use DATA ENTRY Keypad (29) to enter frequency. Press ENTER Key.
- When all desired sequences have been entered, press "Ret" Soft Function Key F5 to return to Duplex Receiver Operation Screen.
- If Tone Rem is selected, Tone Rem Function Menu appears:

Duplex Receiver

Tone Rem Function
1. 2050 (Monitor)
2. 1950 (F1)
3. 1850 (F2)
4. 1750 (R2 Mute)
5. 1650 (R2 Unmute)
6. 1550 (Repeater Off)
7. 1450 (Repeater On)
8. 1350 (Wild Card 1 On)
9. 1250 (Wild Card 1 Off)
10. 1150 (Wild Card 2 On)
11. 1050 (Wild Card 2 Off)

1. Func Gen #1  
2. Func Gen #2  
3. Signaling For  
4. 1. DTMF  
5. 2. Audio  
3. Digital  
4. RCC  
1. IMTS  
2. MTS  
3. 2805  
4. Tone Rem

Scan F.L. Ret ESC

8610368

- Use FIELD SELECT Keys (1) to select a Tone Remote Function and press ENTER Key.
- Press "Ret" Soft Function Key F5 to return to Duplex Receiver Operation Screen.

19. If an Oscilloscope or Spectrum Analyzer display is desired for Duplex Receiver Operation Screen or if this feature is desired in a different size:

- Press "More" Soft Function Key F6 until "Disp" Soft Function Key F1 appears. Press "Disp" Soft Function Key F1.
- A menu appearing in the lower left corner displays following options:

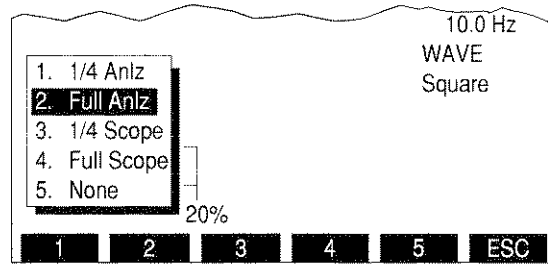

8617084

Select desired screen option using DATA ENTRY Keypad (29).

**NOTE:** 1/4 size Analyzer Screen parameters are edited by selecting full size Analyzer display, editing parameters and reselecting 1/4 size Analyzer display.

20. If "2. Full Anlz" is selected:

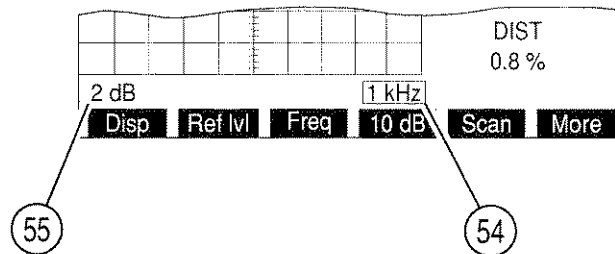

03416050

- Move cursor to Analyzer Scan Width (54) and press ENTER Key to access the data field. Press DATA SCROLL  $\uparrow$  or  $\downarrow$  Keys (3) until desired selection appears in data field and press ENTER Key to activate Scan Width desired.
- Move cursor to Units/Division Factor (55) and press ENTER Key to change this parameter. Pressing ENTER Key toggles value between 2 and 10 dB.

21. If "3. 1/4 Scope" is selected:

- Move cursor to Oscilloscope Input (31) and press ENTER Key to access the data field. Press DATA SCROLL  $\uparrow$  or  $\downarrow$  Keys (3) until desired selection appears in data field and press ENTER Key to activate Oscilloscope Input desired.

**NOTE:** Remaining Oscilloscope parameters are edited by selecting full size Scope display, changing parameters and reselecting 1/4 size Scope display.

22. If "4. Full Scope" is selected:

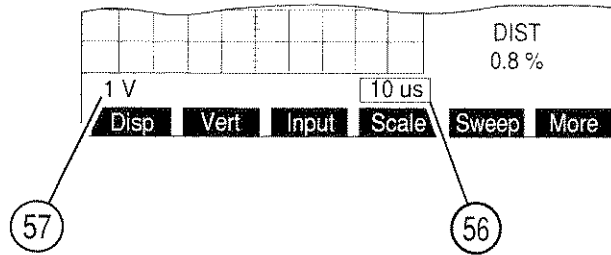

03416051

- Move cursor to Oscilloscope Input (31) and press ENTER Key to access the data field. Press DATA SCROLL ↑ or ↓ Keys (3) until desired selection appears in data field and press ENTER Key to activate selected Oscilloscope Input.
  - Move cursor to Oscilloscope Sweep Rate (56) and press ENTER Key to access the data field. Press DATA SCROLL ↑ or ↓ Keys (3) until desired selection appears in data field and press ENTER Key to activate selected Oscilloscope Sweep Rate.
  - Move cursor to Oscilloscope Scale (57) and press ENTER Key to access the data field. Press DATA SCROLL ↑ or ↓ Keys (3) until desired selection appears in data field and press ENTER Key to activate selected Oscilloscope Scale.
  - If needed, press "More" Soft Function Key F6 until "Vert" Soft Function Key F2 appears. Press "Vert" Soft Function Key F2 and use DATA SCROLL Spinner (2) or DATA SCROLL ↑ or ↓ Keys (3) to adjust vertical position of Oscilloscope Trace. Press ENTER Key.
23. If Modulation Source is desired to be routed to AUDIO OUT Connector (14) or DEMOD OUT Connector (12) or if Speaker use is desired, press SETUP Key to display the Generator Menu. Press 5 DATA ENTRY Key (29) to access RF Gen Setup Menu.

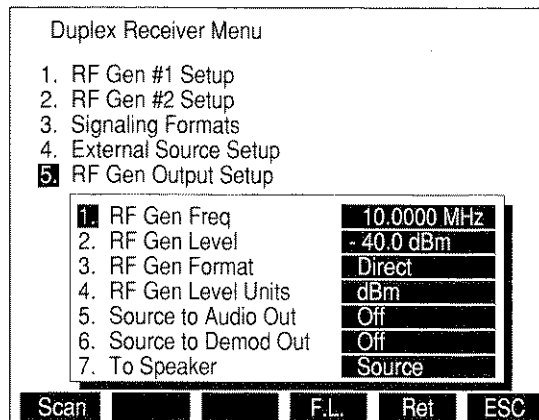

8616009

- Press 5 DATA ENTRY Key (29) as needed to enable or disable Modulation Source routing to AUDIO OUT Connector (14).
- Press 6 DATA ENTRY Key (29) as needed to enable or disable Modulation Source routing to DEMOD OUT Connector (12).

**STEP****PROCEDURE**

- Press 7 DATA ENTRY Key (29) and use DATA ENTRY Keypad (29) to select a signal to be routed to Speaker.

**NOTE:** Routing Source to Speaker disables SINAD and Distortion Meters.

- Press "Ret" Soft Function Key F5 to return to Duplex Receiver Operation Screen.
24. To display SINAD, Distortion or AF Level Meter or Digital Multimeter, press "More" Soft Function Key F6 until "Meters" Soft Function Key F4 appears. Press "Meters" Soft Function Key F4 to display a submenu listing available meters. Use DATA ENTRY Keypad (29) to select a meter. To access a meters Operation Screen, move cursor to Meters Callout and press ENTER Key.

- For SINAD Meter Operation Procedures, see 4-8-7.
- For Distortion Meter Operation Procedures, see 4-8-6.
- For DMM Operation Procedures, see 4-8-10.

**NOTE:** SINAD, Distortion and AF Level Meters measure SINAD/BER IN Connector (15) Input. DMM measures only DMM Connector Input.

**Channel Mode**

25. To operate Duplex Receiver in Channel Mode, press SETUP Key and 5 DATA ENTRY Key (29) to display Duplex Receiver Setup Menu. Press 3 DATA ENTRY Key (29) to display Duplex Receiver Format submenu. Press 2 DATA ENTRY Key (29) to select channel. Press "Chan" Soft Function Key F2 to display Channel Format Menu. Use DATA ENTRY Keypad (29) to select a Channel Format.
- Press "Ret" Soft Function Key F5 to return to Duplex Receiver Operation Screen.
  - Duplex Receiver Frequency is displayed by channel number.
  - See the following Appendices for listings of cellular channels and corresponding frequencies:

CHANNEL FORMAT	APPENDIX
NADC/NAMPS	B
E-TACS	C

**Direct Mode**

26. To operate Duplex Receiver in Channel Mode, press SETUP Key and 5 DATA ENTRY Key (29) to display Duplex Receiver Setup Menu. Press 3 DATA ENTRY Key (29) to display Duplex Receiver Format submenu. Press 1 DATA ENTRY Key (29) to select Direct. Press "Ret" Soft Function Key F5 to return to Duplex Receiver Operation Screen.



### Frequency Scan Mode

27. To operate Duplex Receiver Frequency Scan Mode, press SETUP Key to access Duplex Receiver Menu. Press "Scan" Soft Function Key F1 to access Duplex Receiver Frequency Scan Menu:

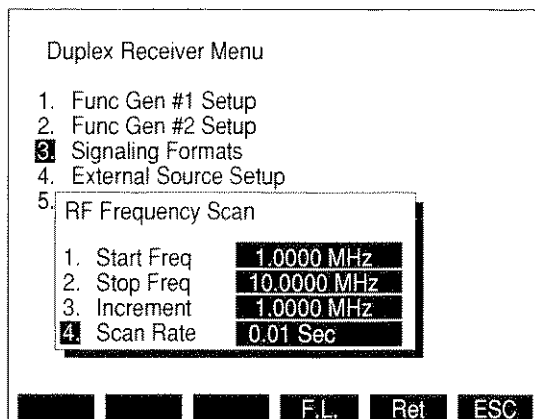

8610382

- Press 1 DATA ENTRY Key (29) to access Starting Frequency. Use DATA ENTRY Keypad (29) to enter Starting Frequency and press ENTER Key.
- Press 2 DATA ENTRY Key (29) to access Stopping Frequency. Use DATA ENTRY Keypad (29) to enter Stopping Frequency and press ENTER Key.
- Press 3 DATA ENTRY Key (29) to access Increment. Use DATA ENTRY Keypad (29) to enter Increment and press ENTER Key.
- Press 4 DATA ENTRY Key (29) to access Scan Rate. Use DATA ENTRY Keypad (29) to enter Scan Rate. Press ENTER Key and "Ret" Soft Function Key F5 to return to Operation Screen.
- Press GO TEST CONTROL Key (28) to start Duplex Receiver Scan. Press STOP TEST CONTROL Key (28) to stop Scanning. Pressing GO TEST CONTROL Key (28) again resumes scanning operation. Press SGL STEP TEST CONTROL Key (28) to single step through scanning operation one increment at a time.

**NOTE:** The following steps use the Frequency List (F.L.) that is shared between the RF Generator, Receiver, Duplex, Duplex Transmitter and Duplex Receiver Operation Screens. The Frequency List can be used as a list to manually select different frequencies or as a table for scanning. When used for scanning, specific frequencies in the Frequency List must be manually toggled On or Off.

### Frequency List Mode

28. To operate Duplex Receiver in Frequency List Mode, press SETUP Key and 5 DATA ENTRY Key (29) to display Duplex Receiver Menu. Press 3 DATA ENTRY Key (29) to display Duplex Receiver Format submenu. Press 4 DATA ENTRY Key (29) to select Freq List. Press "F.L." Soft Function Key F4 to display the Stored RF Frequency List.

- Press ↑ or ↓ FIELD SELECT Keys (1), in conjunction with "Pg Up" or "Pg Dn" Soft Function Keys F1 and F2, as needed, to move cursor to desired Item line in the Frequency List.
- Press ← or → FIELD SELECT Keys (1) as needed to move cursor to select the Generate, Receive or Offset entries (Offset frequency is equal to Generate frequency minus Receive frequency). Press ENTER Key to activate the data field and use DATA ENTRY Keypad (29) to enter desired frequency. Press ENTER Key.
- Continue selecting Item lines and entering frequency values until desired Frequency List is created.
- Press "Clear" Soft Function Key F3 to return the frequency entry selected by the cursor to 0.2500 MHz, the lowest frequency allowable.
- Press "Fill" Soft Function Key F4 to copy the selected frequency entry value into all entries listed below in the same column.
- Press "Ret" Soft Function Key F5 to return to Duplex Receiver Operation Screen.
- Using FIELD SELECT Keys (1), move cursor to RX and press ENTER Key to activate data field. Press ↑ or ↓ DATA SCROLL Keys (3) to select desired frequency. Press ENTER Key.

### Frequency List Scan Mode

29. To operate Duplex Receiver in Frequency List Scan Mode, press SETUP Key and 5 DATA ENTRY Key (29) to display Duplex Receiver Setup Menu. Press 3 DATA ENTRY Key (29) to display Duplex Receiver Format submenu. Press 5 DATA ENTRY Key (29) to select Freq List Scan. Press "F.L." Soft Function Key F4 to display the Stored RF Frequency List.
- Refer to Step 28, Frequency List Mode, to create the desired listing of frequencies.
  - Use the FIELD SELECT Keys (1) and the ENTER Key to toggle the Scan "switch" to 'on' or 'off' for each Item listing. Item listings that are turned off are skipped when the scan operation is activated.
  - Press "Ret" Soft Function Key F5 to return to Duplex Receiver Operation Screen.
  - Press GO TEST CONTROL Key (28) to start Duplex Receiver Scan. Press STOP TEST CONTROL Key (28) to stop Scanning. Pressing GO TEST CONTROL Key (28) again resumes scanning operation. Press SGL STEP TEST CONTROL Key (28) to single step through scanning operation one increment at a time.
  - While scanning or single stepping through the Frequency List, the operation begins again at the first "turned-on" frequency listing after reaching the last frequency listing.

STEP

PROCEDURE

---

- When both the Duplex Receiver and Duplex Transmitter are in Frequency List Scan, operation mode "G Lock" Soft Function Key F3 appears on the Duplex Receiver Operation Screen. Press "G Lock", Soft Function Key F3, to lock the Duplex Transmitter scan frequency to the Duplex Receiver scan frequency during Frequency List Scanning.
30. After parameters of Duplex Receiver Operation Screen are set, connect UUT to Test Set:
- For testing using separate transmit and receive lines, apply UUT transmitter output to T/R Connector (6). Connect DUPLEX OUT Connector (24) to RF input of UUT receiver.
  - For "off the air" Duplex testing, connect antenna to ANTENNA IN Connector (25). Connect DUPLEX OUT Connector (24) or T/R Connector (6) to RF input of UUT receiver.

## 4-5 AF GENERATOR OPERATION

### 4-5-1 AF GENERATOR GENERAL OPERATION

Operate AF Signal Generator using following procedure:

STEP	PROCEDURE
------	-----------

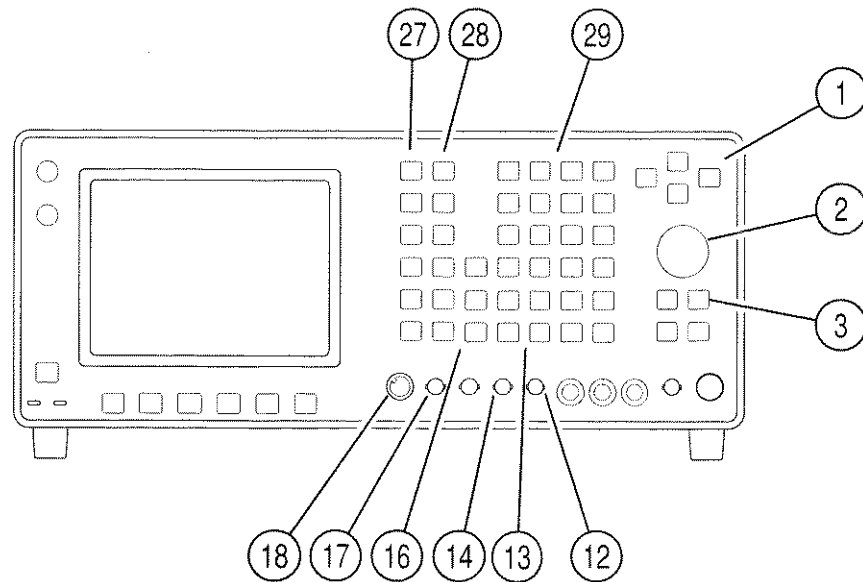

03407013

1. Press AF GEN MODE Key (27). AF Generator Operation Screen appears:

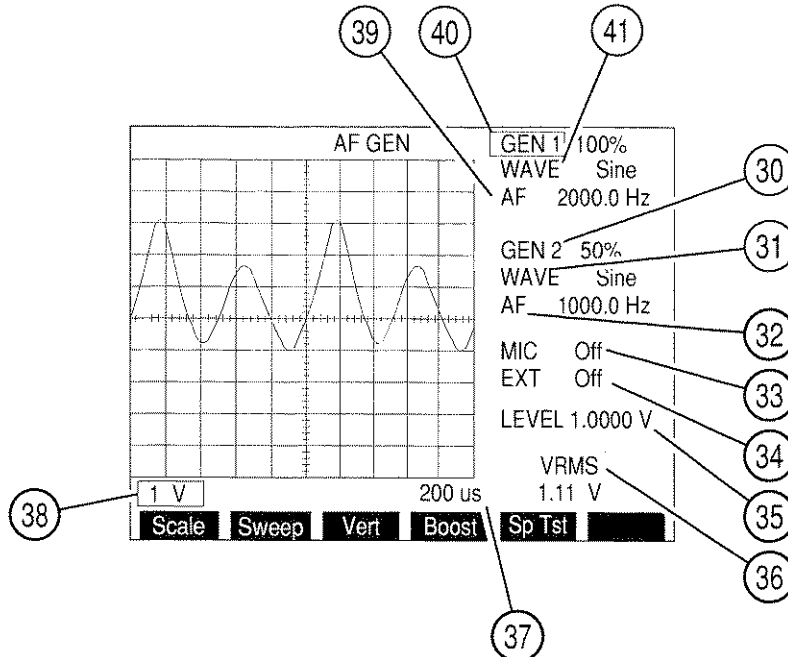

03416128

**NOTE:** When generating signals <2 mV, Receiver squelch must be set to highest level if Receiver is inactive.

2. Press SETUP Key and press 5 DATA ENTRY Key (29) to display AF Output Menu:

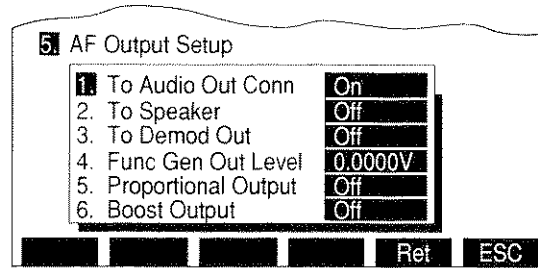

8610388

- Press 5 DATA ENTRY Key (29) to toggle Proportional Output on or off. With proportional Output on, set proportions of the AF Generators and external sources are summed instead of 100% of each. Press "Ret" Soft Function Key F5.
  - Press 6 DATA ENTRY Key (29) to toggle Boost Output On or Off. Synchronizes GEN 2 with GEN 1 to allow AUDIO output to reach 4.0 Vrms. GEN 2 is removed from the screen.
3. Move cursor to GEN 1 (40):
- If Proportional Output is off, press ENTER Key to toggle AF Generator #1 on or off.
  - If Proportional Output is on, press Enter Key and use DATA ENTRY Keypad (29) to enter a proportional percentage. Press ENTER Key.
4. Move cursor to WAVE (41) (GEN 1) and press ENTER Key. Use DATA SCROLL ↑ or ↓ Keys (3) until desired selection appears in data field and press ENTER Key.
5. Move cursor to AF (39) (GEN 1) and press ENTER Key. Use DATA ENTRY Keypad (29) to enter desired frequency and press ENTER Key.
6. Move cursor to GEN 2 (30):
- If Proportional Output is off, press ENTER Key to toggle AF Generator #2 on or off.
  - If Proportional Output is on, press Enter Key and use DATA ENTRY Keypad (29) to enter a proportional percentage. Press ENTER Key.
7. Move cursor to WAVE (31) (GEN 2) and press ENTER Key. Use DATA SCROLL ↑ or ↓ Keys (3) until desired selection appears in data field and press ENTER Key.
8. Move cursor to AF (32) (GEN 2) and press ENTER Key. Use DATA ENTRY Keypad (29) to enter desired frequency and press ENTER Key.
9. Move cursor to MIC (33):
- If Proportional Output is off, press ENTER Key to toggle External MIC/ACC Connector (18) Input on or off.

## STEP

## PROCEDURE

- If Proportional Output is on, press Enter Key and use DATA ENTRY Keypad (29) to enter a proportional percentage. Press ENTER Key.
10. Move cursor to EXT (34):
    - If Proportional Output is off, press ENTER Key to toggle External EXT MOD IN Connector (17) Input on or off.
    - If Proportional Output is on, press Enter Key and use DATA ENTRY Keypad (29) to enter a proportional percentage. Press ENTER Key.
  11. Move cursor to LEVEL (35) and press ENTER Key to access the data field. Use DATA ENTRY Keypad (29) to enter desired output and press ENTER Key to activate AF Generator Output Level.
  12. Measure VRMS Output Level by reading VRMS Digital Readout (36).
  13. Move cursor to Oscilloscope Sweep Rate (37) and press ENTER Key to access the data field. Use DATA SCROLL ↑ or ↓ Keys (3) until desired selection appears in data field and press ENTER Key to activate Sweep Rate.
  14. Move cursor to Oscilloscope Scale (38) and press ENTER Key to access the data field. Use DATA SCROLL ↑ or ↓ Keys (3) until desired selection appears in data field and press ENTER Key.
  15. If needed, press "Vert" Soft Function Key F3 to enable Vertical Adjustment Feature of Oscilloscope. Use DATA SCROLL Spinner (2) or press DATA SCROLL ↑ or ↓ Keys (3) to adjust position of Trace on Oscilloscope grid. When Trace is in desired position, press ENTER Key.
  16. To select AF Generator Outputs, press SETUP Key and 5 DATA ENTRY Key (29) to display AF Output Menu:

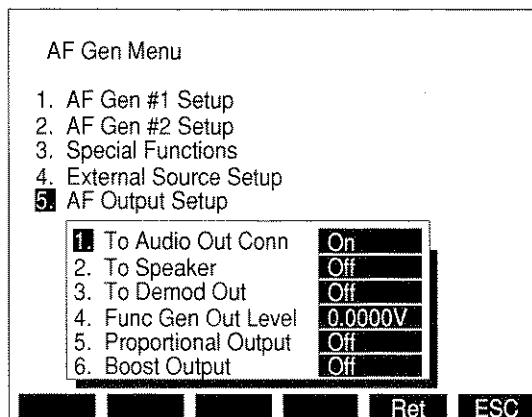

8610328

- For AF Generator Output routed to AUDIO OUT Connector (14), press 1 DATA ENTRY Key (29) to toggle "1. To Audio Out Conn" on or off.
- For AF Generator Output routed to Test Set Speaker, press 2 DATA ENTRY Key (29) to toggle "2. To Speaker" on or off.

- For AF Generator Output routed to DEMOD OUT Connector (12), press 3 DATA ENTRY Key (29) to toggle "3. To Demod Out" on or off.
  - Press "Ret" Soft Function Key F5 to return to AF Generator Operation Screen.
17. For Audio Frequency Scan, press SETUP Key and 3 DATA ENTRY Key (29) to display Special Functions Menu. Press 1 DATA ENTRY Key (29) to display Audio Frequency Scan Menu:

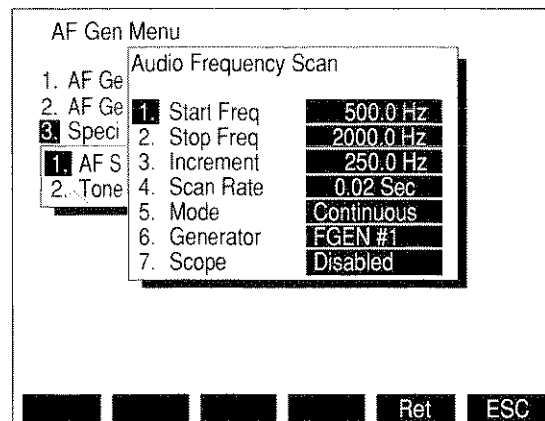

8610102

- Press 1 DATA ENTRY Key (29) and use DATA ENTRY Keypad (29) to enter Starting Frequency.
  - Press 2 DATA ENTRY Key (29) and use DATA ENTRY Keypad (29) to enter Stopping Frequency.
  - Press 3 DATA ENTRY Key (29) and use DATA ENTRY Keypad (29) to enter Increment.
  - Press 4 DATA ENTRY Key (29) and use DATA ENTRY Keypad (29) to enter Scan Rate. Scan Rate data field is blank if "7. Scope" is enabled.
  - Press 5 DATA ENTRY Key (29) to toggle Mode between Continuous and One Shot.
  - Press 6 DATA ENTRY Key (29) to toggle Source between AF Generator #1 and AF Generator #2.
  - Press 7 DATA ENTRY Key (29) to toggle between Scope Enabled and Disabled. Scope Enabled slows Scan Rate.
  - When AF Frequency Scan parameters are set, press GO TEST CONTROL Key (28) to start Scan and press STOP TEST CONTROL Key (28) to stop Scan. Pressing SGL STEP TEST CONTROL Key (28) causes the Scan to increment forward once each time Key is pressed. Pressing AUTO TEST CONTROL Key (28) causes the Scan to increment backward once each time Key is pressed.
- NOTE:** TEST CONTROL Keys (28) operate last accessed Special Function, AF Frequency Scan or Tone Remote Function.
- Press "Ret" Soft Function Key F5 to return to AF Generator Operation Screen.

18. To generate a Tone Remote signal, press SETUP Key and press 3 DATA ENTRY Key (29) to display Special Functions Menu. Press 2 DATA ENTRY Key (29) to display Tone Remote Function Menu:

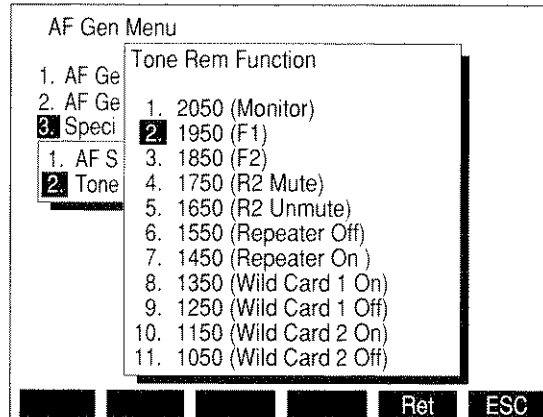

8610158

- Use FIELD SELECT Keys (1) to select a Tone Remote Function and press ENTER Key.
- Press "Ret" Soft Function Key F5 to return to AF Generator Operation Screen.
- Press GO TEST CONTROL (28) to generate Tone Remote Function. Press STOP TEST CONTROL Key (28) to stop generating Tone Remote Function.

**NOTE:** TEST CONTROL Keys (28) operate last accessed Special Function, AF Frequency Scan or Tone Remote Function.



## 4-5-2 GENERATING TONE REMOTE CODE

**EXAMPLE:** The following example generates a Tone Remote Code routed to the AUDIO OUT Connector (14) with a High Level Guard Tone at a 2.5 V (10 dB) level.

STEP	PROCEDURE
1.	Press AF GEN MODE Key (27) to access AF Generator Operation Mode. Press SETUP Key to display AF Gen Menu.
2.	Press 5 DATA ENTRY Key (29) to display the AF Output Setup Menu. <ul style="list-style-type: none"><li>● Press 1 DATA ENTRY Key (29) to toggle "To Audio Out Conn" until <b>On</b> appears.</li><li>● Press 5 DATA ENTRY Key (29) to toggle "Proportional Output" until <b>Off</b> appears.</li><li>● Press "ESC" Soft Function Key F6.</li></ul>
3.	Press 3 and 2 DATA ENTRY Key (29). Move cursor to desired Tone Remote Function and press ENTER Key. Press "Ret" Soft Function Key F5 to return to AF Generator Operating Screen.
4.	Move cursor to GEN 1 (40) and press ENTER Key until <b>Off</b> appears.
5.	Move cursor to GEN 2 (30) and press ENTER Key until <b>Off</b> appears.
6.	Move cursor to LEVEL (35) and press ENTER Key. Press 2, • and 5 DATA ENTRY Keys (29) to set Level to <b>2.5000 V</b> . Press ENTER Key.
7.	Press GO TEST CONTROL Key (28) to generate sequence. Press STOP TEST CONTROL Key (28) to stop sequence.

## 4-5-3 GENERATING AF TONE

**EXAMPLE:** The following example generates a 1 kHz sine wave at a 0.1 V level.

STEP	PROCEDURE
1.	Press AF GEN MODE Key (27) to access AF Generator Operation Mode.
2.	Move cursor to GEN 1 (40) and press ENTER Key until <b>On</b> appears.
3.	Move cursor to WAVE (41) (GEN 1) and press ENTER Key. Press DATA SCROLL ↑ and ↓ Keys (3) until <b>Sine</b> appears and press ENTER Key.
4.	Move cursor to AF (39) (GEN 1) and press ENTER Key. Press 1, 0, 0 and 0 DATA ENTRY Keys (29) to set Audio Frequency to <b>1000.0 Hz</b> . Press ENTER Key.
5.	Move cursor to LEVEL (35) and press ENTER Key. Press • and 1 DATA ENTRY Keys (29) to set Level to <b>0.1000 V</b> . Press ENTER Key.

## 4-6 OSCILLOSCOPE OPERATION

The Oscilloscope is operated using the following procedures:

STEP	PROCEDURE
------	-----------

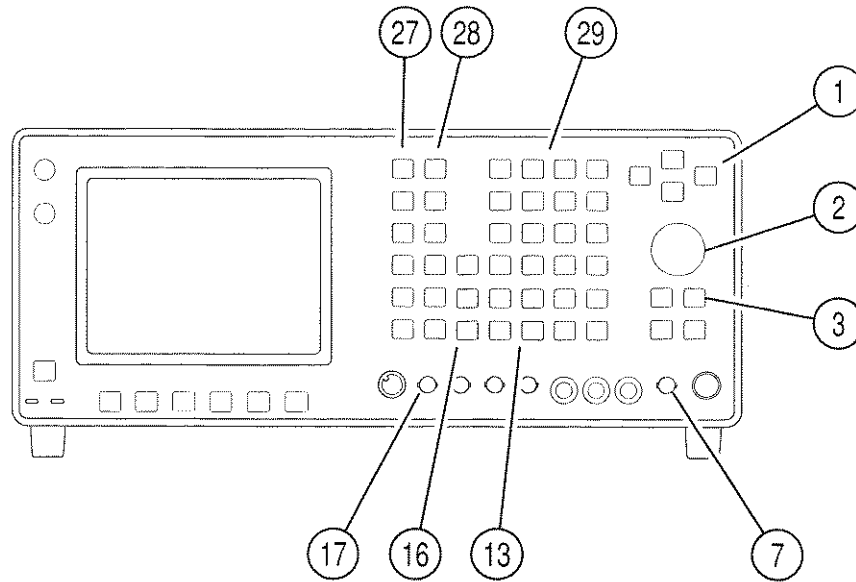

03407014

1. Press SCOPE/ANLZ MODE Key (27). Oscilloscope or Spectrum Analyzer Operation Screen appears. If Spectrum Analyzer Operation Screen appears, press SCOPE/ANLZ MODE Key (27) again to access the Oscilloscope Operation Screen.

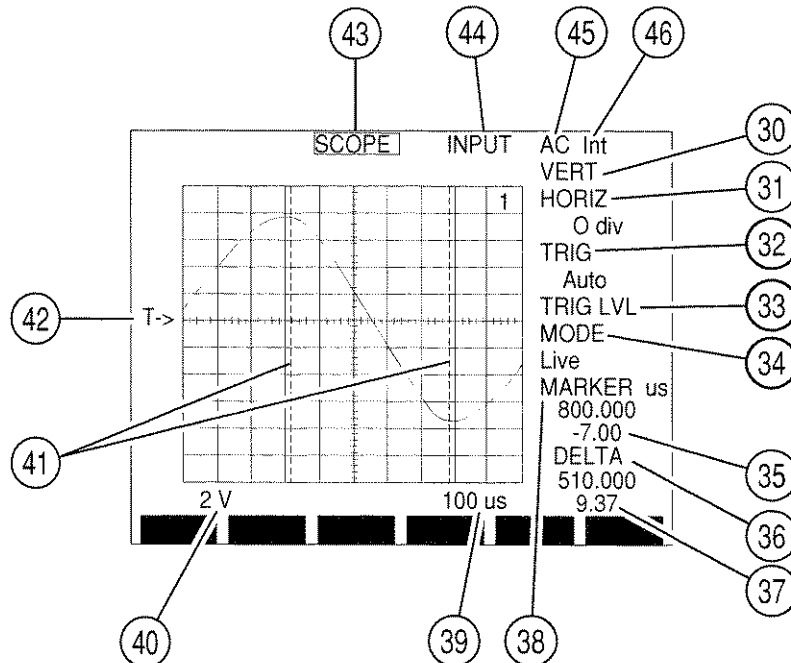

8607067

2. Move cursor to INPUT (44) and press ENTER Key. INPUT Submenu appears overlaying Oscilloscope Operation Screen. Use DATA ENTRY Keypad (29) to select an Input and press ENTER Key.  
**NOTE:** When Rcvr IF is selected for INPUT (44), only INPUT (44) and VERT (30) are selectable.
3. If AC or DC is selected for INPUT (44), move cursor to trigger source (46) and press ENTER Key to toggle trigger source (46) to desired setting. For external trigger, apply external trigger input to EXT MOD IN Connector (17).
4. If Func Gen, Ext Mod, AC, DC, GND or Demod Audio with FM Receiver Modulation is selected for INPUT (44), move cursor to Oscilloscope Scale (40) and press ENTER Key. Use DATA SCROLL ↑ or ↓ Keys (3) to select a scale and press ENTER Key.
5. Unless Rcvr IF is selected for INPUT (44), move cursor to Sweep Rate (39) and press ENTER Key. Use DATA SCROLL ↑ or ↓ Keys (3) to select a Sweep Rate and press ENTER Key.
6. Move cursor to VERT (30) and press ENTER Key. Use DATA SCROLL Spinner (2) or DATA SCROLL ↑ and ↓ Keys (3) to adjust vertical level of Trace and press ENTER Key.
7. Move cursor to HORIZ (31) and press ENTER Key. Use DATA ENTRY Keypad (29) to select Trace Horizontal Offset value and press ENTER Key.
8. Move cursor to TRIG (32) and press ENTER Key. Use DATA SCROLL ↑ and ↓ Keys (3) to select a Trigger Type and press ENTER Key. Press "More" Soft Function Key F6 until "Trig" Soft Function Key F3 appears.
  - If Auto or Norm is selected, press "Start" Soft Function Key F4 to start Trace. With Trace active, Soft Function Key F4 becomes "Stop". Press "Stop" Soft Function Key F4 to freeze Trace.
  - If One Shot is selected, press "Arm" Soft Function Key F4 to freeze a new screen of Trace.
9. To adjust Trigger Level, move cursor to TRIG LVL (33) and press ENTER Key. Use DATA SCROLL Spinner (2) or DATA SCROLL ↑ or ↓ Keys (3) to adjust Trigger Level Indicator higher or lower on Oscilloscope Scale and press ENTER Key.  
Setting Trigger Level in this manner is an approximate setting. To set Trigger Level at an exact point on vertical scale, press SETUP Key and 3 DATA ENTRY Key (29) to access Setup Scope Menu. Press 5 DATA ENTRY Key (29) and use DATA ENTRY Keypad (29) to enter a Trigger Level (0 to 255, where 128 corresponds to middle line).
10. Move cursor to MODE (34) and press ENTER Key. Use DATA ENTRY Keypad (29) to select a Mode. To recall a Trace for Recall or Compare Modes, press RCL MEMORY Key (16), use DATA ENTRY Keypad (29) to select a stored Trace and press ENTER Key.

**NOTE:** When in Recall Mode, only Markers and Oscilloscope Mode are editable.

**NOTE:** When in Compare Mode, recalled Trace remains unchanged when Oscilloscope parameters are changed.

11. To store Oscilloscope Trace and parameters, see 4-1-1.
12. To use Markers, move cursor to MARKER (38). Press "More" Soft Function Key F6 until "Marker" Soft Function Key F1 appears.
  - For Marker 1 use, press "Mkr 1" Soft Function Key F3, use DATA SCROLL Spinner (2) or DATA SCROLL Keys ↑ and ↓ (3) to adjust Mkr 1 position and press ENTER Key. "Mkr 1" appears in red while Marker 1 is the active Marker.
  - For Marker 2 use, press "Mkr 2" Soft Function Key F4, use DATA SCROLL Spinner (2) or DATA SCROLL Keys ↑ and ↓ (3) to adjust Mkr 2 position and press ENTER Key. "Mkr 2" appears in red while Marker 2 is the active Marker.

Marker reading shows active Markers position using Sweep Rate units and referencing display's left side as 0. For AC, DC or GND Input, Marker Voltage Reading (35) (voltage at Marker Trace crossing) is displayed in V.

- To lock Markers a constant distance apart, press "Track" Soft Function Key F5. Use DATA SCROLL Spinner (2) or DATA SCROLL ↑ and ↓ Keys (3) to adjust both Markers at once. Marker and Marker voltage readings reflect Marker 1 position.

Delta reading shows position difference of the two Markers. DELTA Voltage Reading (37) shows voltage difference of the two Marker Trace crossings.

- To deactivate Markers, press "Off" Soft Function Key F2.

**NOTE:** If Marker is "Off", Marker Indicator appears on Oscilloscope grid if Marker Callout is accessed. Marker disappears from grid when Marker value is activated.

13. If needed, install Oscilloscope Probe (optional) to SCOPE IN Connector (7) and attach Oscilloscope Probe to desired test points of UUT.
14. To plot Trace via GPIB or HOST RS-232 Connector:
  - **File Name:** 8607120  
To configure printer parameters (see 6-2). Connect Plotter to GPIB or HOST RS-232 Connector. DEMOD AUDIO - MODE PLOT
  - **Window Size:** 7 X 1-2  
Press PRINT SCREEN TEST CONTROL Key (28). If submenu appears listing print and additions, press 2 DATA ENTRY Key (29). The following submenu appears:

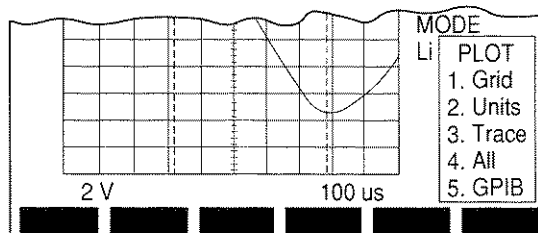

8607120

- Press 5 DATA ENTRY Key (29) to select connector used.

STEP

PROCEDURE

---

- Use DATA ENTRY Keypad (29) to select items to plot until desired items are plotted. Pressing 4 DATA ENTRY Key (29) prints selections 1, 2 and 3.
- After plotting process is complete, press "ESC" Soft Function Key F6.

**NOTE:** To print screen, see 4-1-2.

## 4-7 SPECTRUM ANALYZER OPERATION

### 4-7-1 SPECTRUM ANALYZER GENERAL OPERATION

The Spectrum Analyzer is operated using the following procedures:

STEP	PROCEDURE
------	-----------

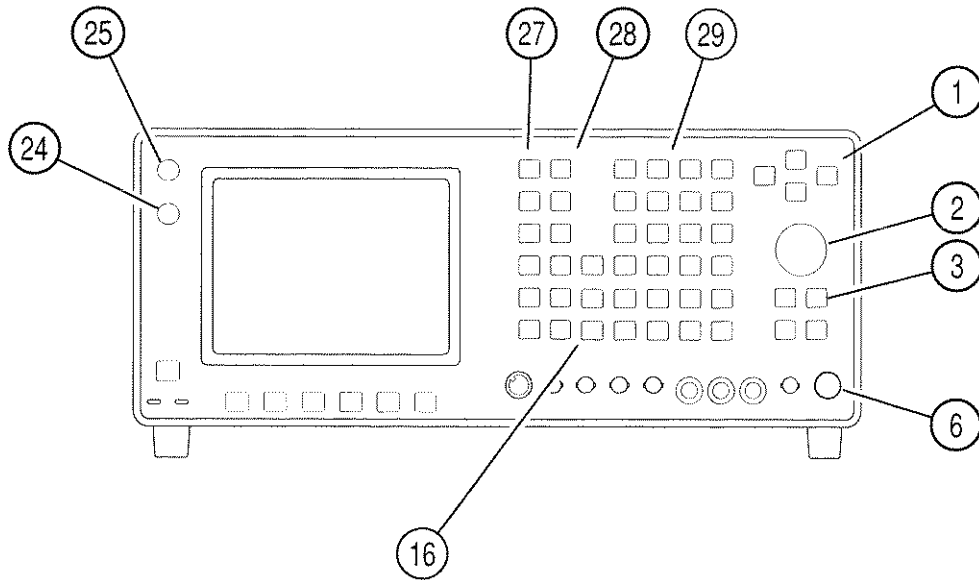

03407015

1. Press SCOPE/ANLZ MODE Key (27). Oscilloscope or Spectrum Analyzer Operation Screen appears. If Oscilloscope Operation Screen appears, press SCOPE/ANLZ MODE Key (27) again. Spectrum Analyzer Operation Screen appears:

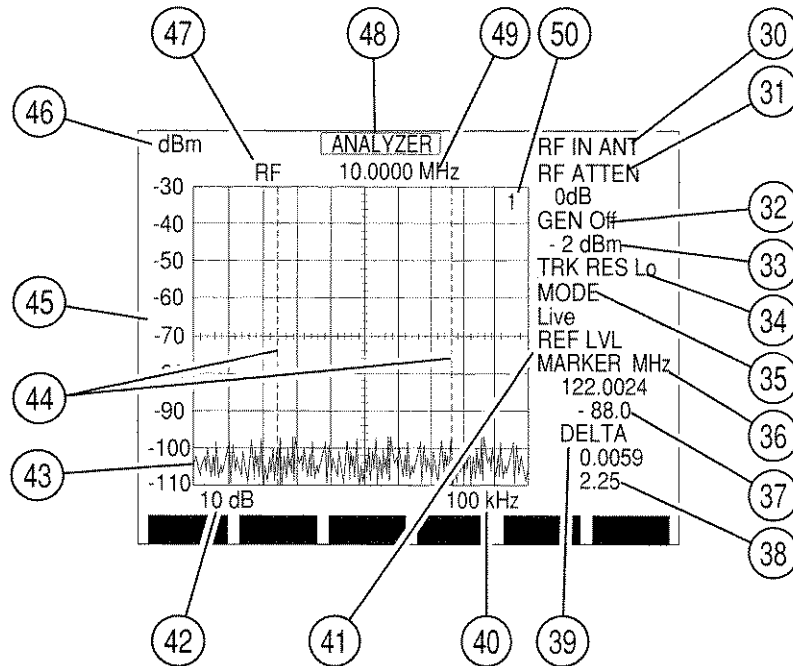

8607326

## STEP

## PROCEDURE

2. Connect RF Source of Spectrum Analyzer Input Signal to ANTENNA IN Connector (25) or T/R Connector (6).  
**CAUTION:** MAXIMUM CONTINUOUS INPUT TO THE ANTENNA IN CONNECTOR (25) IS LIMITED TO 10 W.  
MAXIMUM CONTINUOUS INPUT TO THE T/R CONNECTOR (6) IS LIMITED TO 50 W.
3. Move cursor to RF (47) and press ENTER Key to access data field (49). Use DATA ENTRY Keypad (29) to enter frequency and press ENTER Key.
4. Move cursor to RF IN (30) and press ENTER Key to toggle RF Input location between ANTENNA IN Connector (25) and T/R Connector (6).
5. Move cursor to RF ATTEN (31) and press ENTER Key to access RF Attenuation data field. Use DATA SCROLL ↑ or ↓ Keys (3) to select desired attenuation and press ENTER Key.
6. Move cursor to Analyzer Scale Units (46) and press ENTER Key to activate its data field. Use DATA SCROLL ↑ or ↓ Keys (3) to select desired scale and press ENTER Key.
7. Move cursor to Scan Width (40) and press ENTER Key to access its data field. Use DATA SCROLL ↑ and ↓ Keys (3) to select desired Scan Width and press ENTER Key.
8. To activate Tracking Generator:
  - Press “More” Soft Function Key F6 until “Trk Gen” Soft Function Key F2 appears. Press “Trk Gen” Soft Function Key F2 until “Trk Gen” appears in red to activate Tracking Generator.
  - Move cursor to Tracking Generator Output Connector (33) and press ENTER Key to toggle selection to T/R (T/R Connector) (6) or DPL (DUPLEX OUT Connector) (24).
  - Move cursor to GEN (32) and press ENTER Key. Use DATA ENTRY Keys (29) to set Tracking Generator Level and press ENTER Key.
  - Move cursor to TRK RES (34) and press ENTER Key to toggle Tracking Generator Resolution to Lo, Me or Hi.
9. To normalize Spectrum Analyzer if Tracking Generator is off, press “More” Soft Function Key F6 until “Norm” Soft Function Key F1 appears. Press “Norm” Soft Function Key F1.
10. Move cursor to MODE (35) and press ENTER Key to display Spectrum Analyzer Mode Submenu. Use DATA ENTRY Keys (29) to select an Operation Mode and press ENTER Key. To recall a Trace for Recall or Compare Modes, press RCL MEMORY Key (16), use DATA ENTRY Keypad (29) to select a stored Trace and press ENTER Key.

**NOTE:** When in Recall Mode, only Markers and Analyzer Mode are editable.

**NOTE:** When in Compare Mode, recalled Trace remains unchanged when Analyzer parameters are changed.

11. If Units/Division Factor (42) is set to 2 dB/div, move cursor to REF LVL (41) and press ENTER Key. Use DATA SCROLL Spinner (2) or DATA SCROLL ↑ and ↓ Keys (3) to adjust Reference Level as desired and press ENTER Key. Analyzer Grid Vertical Scale (45) changes to reflect different reference.
12. To use Markers, press “More” Soft Function Key F6 until “Mkr 1” Soft Function Key F3 appears.
  - For Marker 1 use, press “Mkr 1” Soft Function Key F3, use DATA SCROLL Spinner (2) or DATA SCROLL Keys (3) to adjust Marker 1 position and press ENTER Key. “Mkr 1” appears in red while Marker 1 is the active Marker.
  - For Marker 2 use, press “Mkr 2” Soft Function Key F4, use DATA SCROLL Spinner (2) or DATA SCROLL Keys (3) to adjust Marker 2 position and press ENTER Key. “Mkr 2” appears in red while Marker 2 is the active Marker.

Marker reading (36) shows active Markers position in MHz. Marker Amplitude Reading (37) (amplitude at Marker Trace crossing) is displayed in current Analyzer Grid units.

- To lock Markers a constant distance apart, press “Track” Soft Function Key F5. Use DATA SCROLL Spinner (2) or DATA SCROLL Keys (3) to adjust both Markers at once. Marker readings reflect Marker 1 position.

DELTA reading shows position difference of Markers in MHz. DELTA Amplitude Reading (38) shows amplitude difference of each Marker Trace crossing in current Analyzer Grid units.

- To change RF Frequency (49) to active Markers frequency, press “Mkr Fc” Soft Function Key F1.
- To deactivate Markers, press “Off” Soft Function Key F2.

**NOTE:** If Marker is off, Marker Indicator appears on Analyzer display when Marker Callout is accessed and may be edited. Marker disappears from grid when Marker value is activated.

13. To operate Spectrum Analyzer in Channel Mode, press SETUP Key and 4 DATA ENTRY Key (29) to display Analyzer Setup Menu. Move cursor to “12. RF Mode” and press ENTER Key until Channel is selected. Press “Chan” Soft Function Key F1 to display Channel Format Menu. Use DATA ENTRY Keypad (29) to select a Channel Format. Press “Ret” Soft Function Key F5 to return to Spectrum Analyzer Operation Screen.
14. To operate Spectrum Analyzer in Direct Mode, press SETUP Key and 4 DATA ENTRY Key (29) to display Analyzer Setup Menu. Move cursor to “12. RF Mode” and press ENTER Key until Direct is selected. Press “Ret” Soft Function Key F5 to return to Spectrum Analyzer Operation Screen.



15. To operate Find Function (relocate RF Frequency [49] to first signal with amplitude greater than Find level):
  - If Tracking Generator is on, press "More" Soft Function Key F6 until "Trk Gen" Soft Function Key F2 appears. Press "Trk Gen" Soft Function Key F2 to deactivate Tracking Generator.
  - Press "More" Soft Function Key F6 until "Find" Soft Function Key F1 appears. Press "Find lvl" Soft Function Key F2. Red horizontal line appears.
  - Use DATA SCROLL Spinner (2) or DATA SCROLL Keys (3) to adjust red horizontal line to desired amplitude level and press ENTER Key.
  - Press "Find" Soft Function Key F1. Find Function searches for lowest frequency with signal amplitude greater than Find level. RF Frequency (49) is also changed to frequency found.
16. To operate Cable Fault Testing:
  - Connect 50  $\Omega$  coaxial cable between ANTENNA IN Connector (25) and a coaxial T connector to T/R Connector (6). Connect coaxial cable under test to other side of coaxial T connector.
  - Move cursor to GEN (32) and press +/-, 3 and 0 DATA ENTRY Keys (29). Press ENTER Key. If Tracking Generator is on, press "More" Soft Function Key F6 until "Trk Gen" Soft Function Key F2 appears. Press "Trk Gen" Soft Function Key F2 to turn Tracking Generator off.
  - Move cursor to Scan Width (40) and press DATA SCROLL  $\uparrow$  and  $\downarrow$  Keys (3) to set Scan Width (40) to 100 MHz. Press ENTER Key.
  - Move cursor to Division/Factor Units (42) and press ENTER Key until 10 dB/div appears.
  - Press "More" Soft Function Key F6 until "Cbl Flt" Soft Function Key F3 appears. Press "Cbl Flt" Soft Function Key F3.
  - Move cursor to VEL FACT (51) and use DATA ENTRY Keypad (29) to enter velocity factor of cable under test. Press ENTER Key.
  - Note location of lowest group of troughs displayed. Move cursor to Scan Width (40) and press DATA SCROLL  $\downarrow$  Key (3) to set Scan Width (40) to 50 MHz. Press ENTER Key.
  - Move cursor to RF (47) and use DATA ENTRY Keys (29) to set Analyzer RF Frequency to center of troughs. Press ENTER Key.
  - Move cursor to Scan Width (40) and use DATA SCROLL  $\uparrow$  and  $\downarrow$  Keys (3) to set Scan Width (40) until only two or three troughs appear. Press ENTER Key.
  - Move cursor to Division/Factor Units (42) and press ENTER Key to select 2 dB/div.

- Press “Find lvl” Soft Function Key F2 and use DATA SCROLL Spinner (2) or DATA SCROLL ↑ and ↓ Keys (3) to adjust red horizontal line to lowest point while touching two troughs as shown in Figure 4-1. Press ENTER Key.

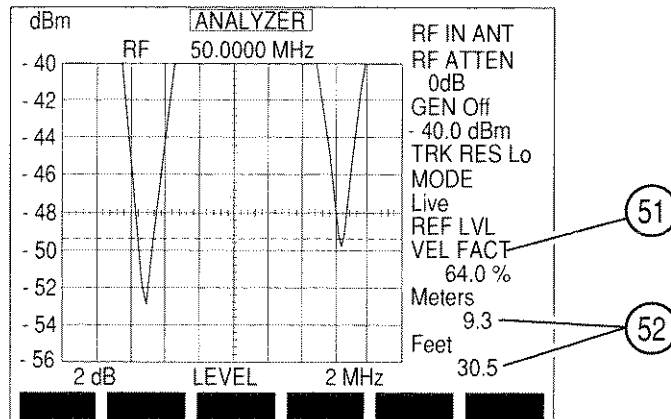

8617067

Figure 4-1 Cable Fault Horizontal Marker Setting

- Press GO TEST CONTROL Key (28). Cable Fault Length readout (52) displays in meters and feet.
17. To activate RF Lock Function, press SETUP Key to access Analyzer Setup Menu. Press “RF lock” Soft Function Key F1. RF Lock locks Analyzer RF Frequency to RF Generator Frequency and Receiver RF Frequency. “RF lock” appears in red when active. Press “RF lock” Soft Function Key F1 to deactivate RF Lock Function.
  18. To plot Trace via GPIB or HOST RS-232 Connector:
    - Configure printer parameters (see 6-2). Connect plotter (HPGL format) to GPIB or HOST RS-232 Connector.
    - Press PRINT SCREEN TEST CONTROL Key (28). If submenu appears listing print and plot options, press 2 DATA ENTRY Key (29). The following submenu appears:

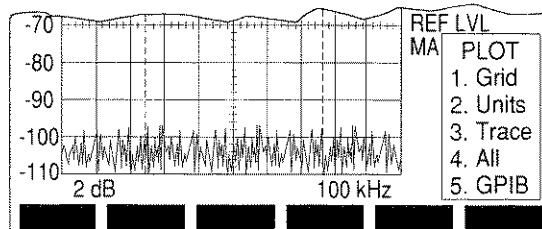

8607121

- Press 5 DATA ENTRY Key (29) to select connector used.
- Use DATA ENTRY Keys (29) to select items to plot until desired items are plotted. Press “ESC” Soft Function Key F6 once plotting process is complete.

**NOTE:** To print screen, see 4-1-2.

## 4-7-2 MEASURING VERY LOW POWER TRANSMITTER OUTPUT

### STEP

### PROCEDURE

1. Press SCOPE/ANLZ MODE Key (27). If Oscilloscope Operation Screen appears, press SCOPE/ANLZ MODE Key (27) again.
2. Move cursor to RF (47) and use DATA ENTRY Keypad (29) to enter transmitting frequency of UUT. Press ENTER Key.
3. If Tracking Generator is on, press "More" Soft Function Key F6 until "Trk Gen" Soft Function Key F2 appears. Press "Trk Gen" Soft Function Key F2 to turn Tracking Generator **Off**.
4. If needed, move cursor to MODE (35) and press ENTER Key. Press 1 DATA ENTRY Key (29) to select **Live Mode**.
5. Move cursor to Units/Division Factor (42) and press ENTER Key until **10 dB** appears.
6. Move cursor to RF ATTEN (31) and press DATA SCROLL ↑ and ↓ Keys (3) until **0 dB** appears. Press ENTER Key.
7. Move cursor to RF IN (30) and press ENTER Key until **T/R** is selected.
8. Move cursor to Analyzer Scale Units (46) and press DATA SCROLL ↑ and ↓ Keys (3) until **dBm** appears. Press ENTER Key.
9. Apply test signal to T/R Connector (6) and read power level using Analyzer Scale (45).
10. If reading is <-30 dBm, disconnect incoming signal from T/R Connector (6) and apply signal to ANTENNA IN Connector (25). Move cursor to RF IN (30) and press ENTER Key until **ANT** appears.
11. Press "More" Soft Function Key F6 until "Mkr 1" Soft Function Key F3 appears. Press "Mkr 1" Soft Function Key F3 to highlight Marker Position data field.
12. Rotate DATA SCROLL Spinner (2) until Marker 1 lies directly on peak of specified signal. Marker Amplitude Reading (37) displays power at point of signal crossing of Marker 1. For dBm, W and dBW conversions, see Table 4-1.

dBm	W	dBW	dBm	μW	dBW
+50	100	20	-10	100	-40
+40	10	10	-20	10	-50
+30	1	0	-30	1	-60
+20	0.1	-10	-40	0.1	-70
+10	0.01	-20	-50	0.01	-80
0	0.001	-30	-60	0.001	-90

Table 4-1 dBm, W and dBW Conversions

### 4-7-3 MEASURING TRANSMITTER HARMONICS

STEP	PROCEDURE
1.	Press SCOPE/ANLZ MODE Key (27). If Oscilloscope Operation Screen appears, press SCOPE/ANLZ MODE Key (27) again.
2.	Move cursor to RF (47) and use DATA ENTRY Keypad (29) to enter transmitting frequency under test. Press ENTER Key.
3.	If Tracking Generator is on, press "More" Soft Function Key F6 until "Trk Gen" Soft Function Key F2 appears. Press "Trk Gen" Soft Function Key F2 to turn Tracking Generator <b>Off</b> .
4.	If needed, move cursor to MODE (35) and press ENTER Key. Press 1 DATA ENTRY Key (29) to select <b>Live Mode</b> .
5.	Move cursor to RF IN (30) and press ENTER Key until <b>T/R</b> appears.
6.	Move cursor to Units/Division Factor (42) and press ENTER Key until <b>10 dB</b> appears.
7.	Apply signal under test to T/R Connector (6) and read power level using Analyzer Scale (45).
8.	If reading is < -30 dBm, disconnect incoming signal from T/R Connector (6) and apply signal to ANTENNA IN Connector (25). Move cursor to RF IN (30) and press ENTER Key until <b>ANT</b> appears.
9.	Move cursor to RF ATTEN (31) and press ENTER Key. Press DATA SCROLL ↑ and ↓ Keys (3) until <b>0 dB</b> appears and press ENTER Key.
10.	Move cursor to Scan Width (40) and use DATA SCROLL ↑ and ↓ Keys (3) to adjust Scan Width until fundamental frequency and second harmonic appears alone.
11.	Press "More" Soft Function Key F6 until "Mkr 1" Soft Function Key F3 appears. Press "Mkr 1" Soft Function Key F3 to highlight Marker Position data field.
12.	Rotate DATA SCROLL Spinner (2) until Marker 1 lies directly on peak of fundamental frequency. Press "Mkr 2" Soft Function Key F4 to activate Marker 2. Rotate DATA SCROLL Spinner (2) until Marker 2 lies directly on peak of second harmonic frequency. DELTA Amplitude Reading (38) displays amplitude difference, in dB, of fundamental frequency and second harmonic.

#### 4-7-4 MEASURING DIPLEXER TX LOSS AND RX ISOLATION

STEP	PROCEDURE
1.	Press SCOPE/ANLZ MODE Key (27). If Oscilloscope Operation Screen appears, press SCOPE/ANLZ MODE Key (27) again.
2.	Move cursor to RF (47) and use DATA ENTRY Keys (29) to select a frequency in center of transmitting frequencies. Press ENTER Key.
3.	Move cursor to RF IN (30) and press ENTER Key until <b>T/R</b> appears.
4.	Move cursor to RF ATTEN (31) and press DATA SCROLL ↑ Key (3) until <b>0dB</b> appears. Press ENTER Key.
5.	Move cursor to Analyzer Scale Units (46) and press DATA SCROLL ↑ Key (3) until <b>dBm</b> appears. Press ENTER Key.
6.	If Tracking Generator is off, press "More" Soft Function Key F6 until "Trk Gen" Soft Function Key F2 appears. Press "Trk Gen" Soft Function Key F2.
7.	Press "More" Soft Function Key F6 until "Trk Res" Soft Function Key F1 appears. Press "Trk Res" Soft Function Key F1. Press DATA SCROLL ↑ Key (3) until <b>3 MHz</b> appears and press ENTER Key.
8.	Move cursor to GEN (32) and press 0 DATA ENTRY Key (29) to set Tracking Generator Output Level to <b>0.0 dBm</b> . Press ENTER Key.
9.	Move cursor to Scan Width (40) and press DATA SCROLL ↑ and ↓ Keys (3) to select a scan width that displays all of the transmitting frequencies on Analyzer display. Press ENTER Key.
10.	Move cursor to Units/Division Factor (42) and press ENTER Key until <b>2 dB</b> appears.
11.	Move cursor to REF LVL (41) and rotate DATA SCROLL Spinner (2) cw until top of Analyzer Vertical Scale (45) reads 10 dBm. Press ENTER Key.
12.	Connect coaxial cable between DUPLEX OUT Connector (24) and T/R Connector (6). The resulting trace is the Tx reference level. Press STORE MEMORY Key (16) and use DATA ENTRY Keys (29) to select an unused memory location. Press SHIFT Key and T, X, R, E and F DATA ENTRY Keys (29). Press SHIFT Key and ENTER Key.
13.	Disconnect coaxial cable from Test Set and connect DUPLEX OUT Connector (24) to Diplexer Tx input. Connect T/R Connector (6) to Diplexer Tx Output.
14.	Press RCL MEMORY Key (16) and press DATA ENTRY Key (29) used to store Tx reference level trace. Press ENTER Key. Tx reference trace appears frozen on color display.
15.	Press ENTER Key and press 3 DATA ENTRY Key (29) to select Compare Mode. Tx reference trace (frozen) and Tx Output trace (live) appear on color display. Difference between Tx reference trace and Tx Output trace is Diplexer Tx loss.
16.	Move cursor to Units/Division Factor (42) and press ENTER Key until <b>10 dB</b> appears.

STEP

PROCEDURE

---

17. Disconnect coaxial cables and connect coaxial cable between DUPLEX OUT Connector (24) and T/R Connector (6). Resulting trace is the Rx reference trace. Press STORE MEMORY Key (16) and use DATA ENTRY Keys (29) to select an unused memory location. Press SHIFT Key and R, X, R, E and F DATA ENTRY Keys (29). Press SHIFT Key and ENTER Key.
18. Disconnect coaxial cable from Test Set and connect DUPLEX OUT Connector (24) to Diplexer Tx Input. Connect T/R Connector (6) to Diplexer Rx Input.
19. Press RCL MEMORY Key (16) and press DATA ENTRY Key (29) used to store Rx reference level trace. Press ENTER Key. Rx reference trace appears frozen on color display.
20. Press ENTER Key and press 3 DATA ENTRY Key (29) to select Compare Mode. Rx reference trace (frozen) and Rx Input trace (live) appear on color display. Rx Input trace is transmitter leakage into Diplexer Rx.

## 4-8 METER OPERATION

### 4-8-1 AUDIO FREQUENCY METER OPERATION

Received or generated Audio Frequency signals are measured using following procedures:

**NOTE:** The Audio Frequency Meter is accessed from Receive Operation Screen, Duplex Operation Screen, Duplex Transmitter Operation Screen or Meters Menu. Meter reflects readings of last Operation Mode of Test Set.

STEP	PROCEDURE
------	-----------

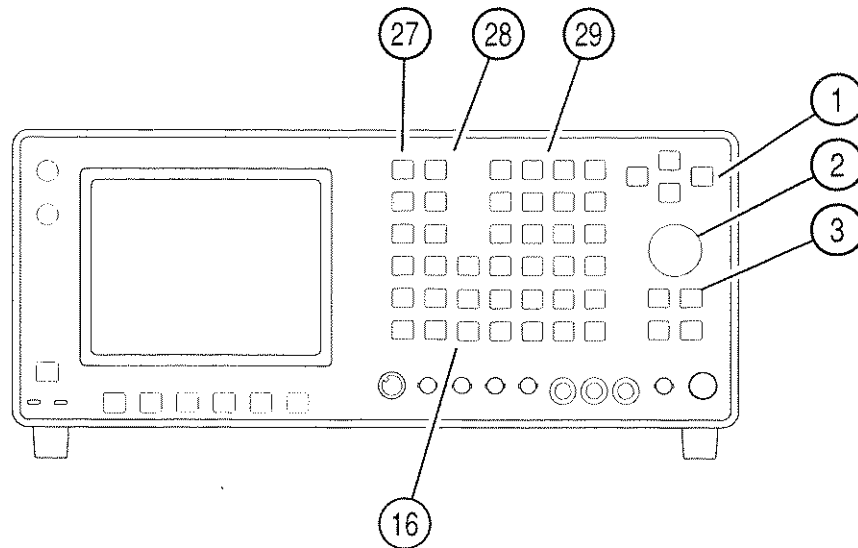

03407016

1. Press MTRS MODE Key (27). Press 1 DATA ENTRY Key (29) to access Audio Frequency Meter Operation Screen.

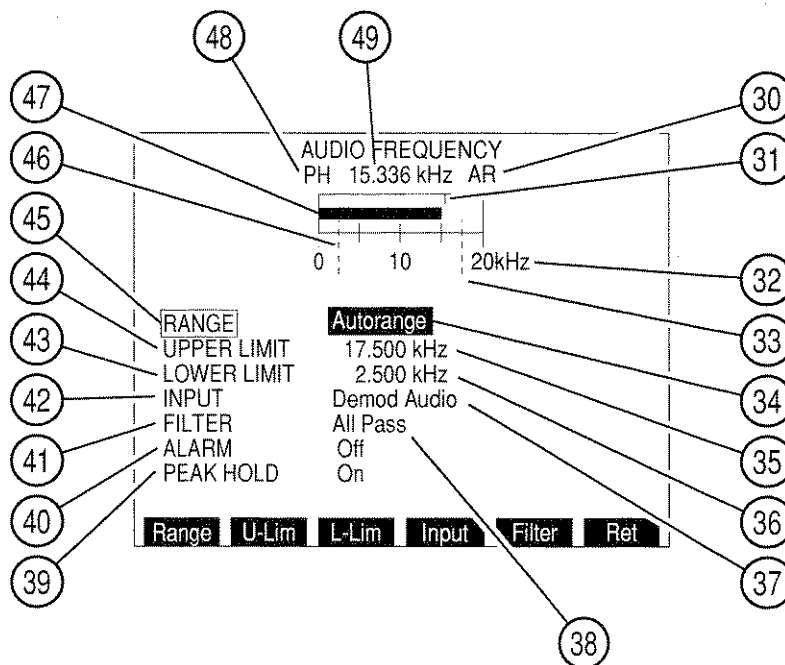

8607069

**NOTE:** When measuring signals <0.6 V through SINAD/BER IN Connector, Receiver squelch must be set to highest level if Receiver is not in use.

2. Move cursor to RANGE (45) and press ENTER Key to access data field (34). Press DATA SCROLL ↑ or ↓ Keys (3) to select desired Range and press ENTER Key.
3. Move cursor to UPPER LIMIT (44). Press ENTER Key to activate Upper Limit and access data field (35). Use DATA ENTRY Keypad (29) to enter desired Upper Limit and press ENTER Key. A blue line (33) appears across meter window marking position of Upper Limit.
4. Move cursor to LOWER LIMIT (43). Press ENTER Key to activate Lower Limit and access data field (36). Use DATA ENTRY Keypad (29) to enter desired Lower Limit and press ENTER Key. A blue line (46) appears across meter window marking position of Lower Limit.
5. To deactivate Upper or Lower Limit, press SETUP Key to display AF Meter Menu. Press 6 (Upper Limit) or 8 (Lower Limit) DATA ENTRY Key (29) to toggle Limit Off. Press "Ret" Soft Function Key F5 to return to AF Meter Operation Screen.
6. Move cursor to INPUT (42) and press ENTER Key to access data field (37). Use DATA SCROLL ↑ and ↓ Keys (3) to select an Input and press ENTER Key.
7. Press SETUP Key to display AF Meter Menu.
  - Press 2 DATA ENTRY Key (29) to display a Filter submenu. Use DATA ENTRY Keypad (29) to select a Filter. If Low Pass or High Pass is selected, a data field appears. Use DATA ENTRY Keypad (29) to enter cutoff frequency and press ENTER Key.
  - Press 4 DATA ENTRY Key (29) to toggle Gate Time to desired setting. Press "Ret" Soft Function Key F5 to return to Audio Frequency Meter Operation Screen.
8. Move cursor to ALARM (40) and press ENTER Key to enable or disable Alarm. Enabled Alarm sounds when Upper or Lower Limit is exceeded.
9. Move cursor to PEAK HOLD (39) and press ENTER Key to enable or disable Peak Hold feature of AF Frequency Meter. PH (48) appears at upper left of meter window and Peak Hold indicator (31) appears on meter indicating highest point reached by Meter Indicator Bar (47).
10. Measure AF Frequency using Meter Indicator Bar (47) or Digital Meter Readout (49) in Hz or kHz.
11. To store or recall a set of AF Meter parameters, see 4-1-1.
12. To Return to last Operation Screen, press "Ret" Soft Function Key F6.



## 4-8-2 RF FREQUENCY ERROR METER OPERATION

Received Radio Frequencies and Frequency Error (the difference between Received Radio Frequency and frequency setting of Receive Operation Screen or Duplex Transmitter Operation Screen) is measured using the following procedures:

Frequency Error Meter is accessed from Receive Operation Screen, Duplex Operation Screen or Meter Menu. Meter reflects readings of last Operation Mode of Test Set.

**NOTE:** When Deviation Meter (Peak) readings exceed Deviation Meter (Peak) Range, the RF Frequency Error Meter may give erroneous results.

STEP PROCEDURE

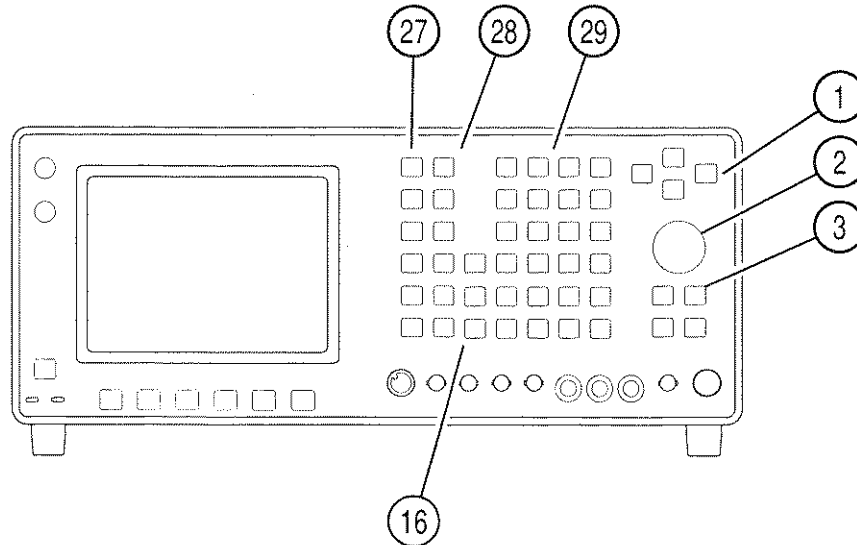

03407016

1. Press MTRS MODE Key (27). Press 2 DATA ENTRY Key (29) to access RF Frequency Error Meter Operation Screen.

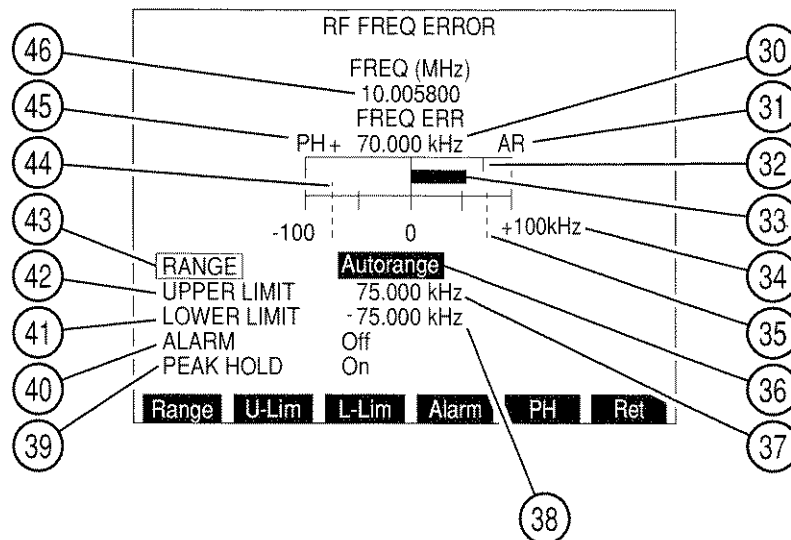

8607070

## STEP

## PROCEDURE

- 
2. Move cursor to RANGE (43) and press ENTER Key to access data field (36). Rotate DATA SCROLL Spinner (2) or press DATA SCROLL ↑ or ↓ Keys (3) to select desired Range and press ENTER Key.
  3. Move cursor to UPPER LIMIT (42). Press ENTER Key to activate Upper Limit and access data field (37). Use DATA ENTRY Keypad (29) to enter desired Upper Limit and press ENTER Key. A blue line (35) appears across meter window marking position of Upper Limit.  
**NOTE:** The Upper Limit for RF Frequency Error Meter is positive and affects only meter bar deflections in right half of meter window (frequency error above Receive RF setting or Duplex Transmitter FREQ setting).
  4. Move cursor to LOWER LIMIT (41). Press ENTER Key to activate Lower Limit and access data field (38). Use DATA ENTRY Keypad (29) to enter desired Lower Limit and press ENTER Key. A blue line (44) appears across meter window marking position of Lower Limit.  
**NOTE:** The Lower Limit for RF Frequency Error Meter is negative and affects only meter bar deflections in left half of meter window (frequency error below Receive RF setting or Duplex Transmitter FREQ setting).
  5. To deactivate Upper or Lower Limit, press SETUP Key to display RF Frequency Error Meter Menu. Press 4 (Upper Limit) or 6 (Lower Limit) DATA ENTRY Key (29) to toggle Limit Off. Press "Ret" Soft Function Key F5 to return to RF Frequency Error Meter Operation Screen.
  6. Move cursor to ALARM (40) and press ENTER Key to enable or disable Alarm. Enabled Alarm sounds when Upper or Lower Limit is exceeded.
  7. Move cursor to PEAK HOLD (39) and press ENTER Key to enable or disable Peak Hold feature of RF Meter. PH (45) appears at upper left of meter window and Peak Hold indicator (32) appears on meter indicating highest point reached by Meter Indicator Bar (33).
  8. Measure Received Frequency using Received Frequency Digital Readout (46). Measure Frequency Error using Meter Indicator Bar (33) or Frequency Error Digital Readout (30).
  9. To store or recall a set of RF Frequency Error Meter parameters, see 4-1-1.
  10. To return to last Operation Screen, press "Ret" Soft Function Key F6.

### 4-8-3 POWER METER OPERATION

Power Meter measurements of RF signals received at T/R Connector (6) are measured using following procedures:

**NOTE:** The RF Power Meter is accessed from Receive Operation Screen, Duplex Transmitter Operation Screen or Meter Menu. Meter reflects readings of last Operation Mode of Test Set.

STEP PROCEDURE

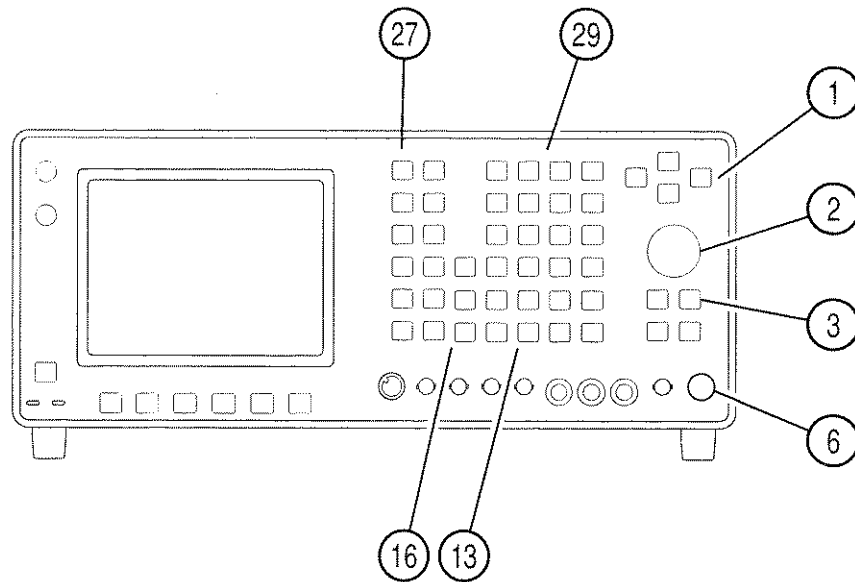

03407017

1. Press MTRS MODE Key (27). Press 3 DATA ENTRY Key (29) to access Power Meter Operation Screen.

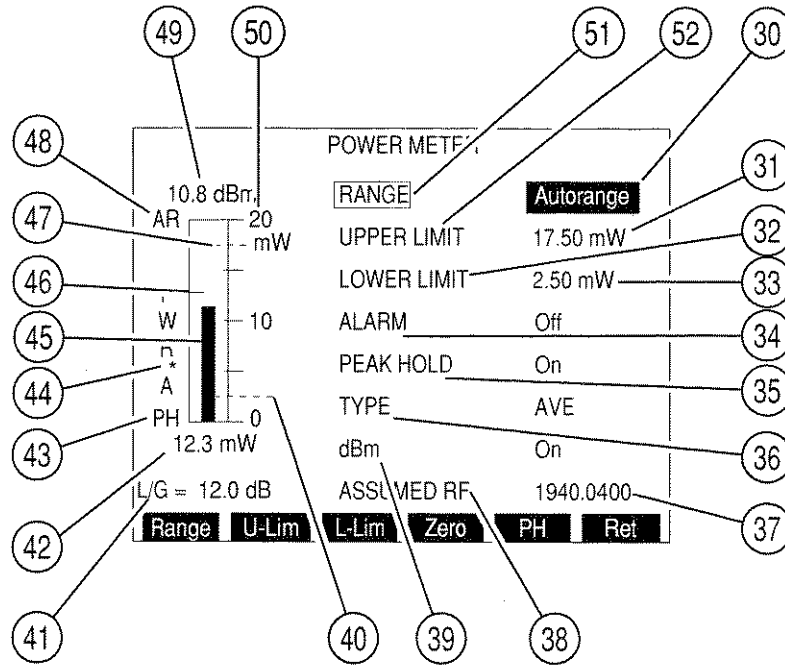

03416042

## STEP

## PROCEDURE

2. Move cursor to RANGE (51) and press ENTER Key to access data field (30). Press DATA SCROLL ↑ or ↓ Keys (3) to select desired Range and press ENTER Key.
3. Move cursor to UPPER LIMIT (52). Press ENTER Key to activate Upper Limit and access data field (31). Use DATA ENTRY Keypad (29) to enter desired Upper Limit and press ENTER Key. A blue line (47) appears across meter window marking position of Upper Limit.
4. Move cursor to LOWER LIMIT (32). Press ENTER Key to activate Lower Limit and access data field (33). Use DATA ENTRY Keypad (29) to enter desired Lower Limit and press ENTER Key. A blue line (40) appears across meter window marking position of Lower Limit.
5. To deactivate Upper or Lower Limit, press SETUP Key to display Power Meter Menu. Press 5 (Upper Limit) or 7 (Lower Limit) DATA ENTRY Key (29) to toggle Limit Off. Press "Ret" Soft Function Key F5 to return to Power Meter Operation Screen.
6. Move cursor to ALARM (34) and press ENTER Key to enable or disable Alarm. Enabled Alarm sounds when Upper or Lower Limit is exceeded.
7. Move cursor to PEAK HOLD (35) and press ENTER Key to enable or disable Peak Hold feature of Power Meter. PH (43) appears at lower left of meter window and Peak Hold indicator (46) appears on meter indicating highest point reached by Meter Indicator Bar (45).
8. Move cursor to TYPE (36) and press DATA SCROLL ↑ Key (3) to select type of Power measurement. Press ENTER Key.
9. Move cursor to dBm (39) and press ENTER Key to enable or disable dBm Readout (49) of Power Meter.
10. Move cursor to ASSUMED RF (38) and press ENTER Key to access data field (37). Use DATA ENTRY Keypad (29) to enter frequency, within 1 MHz, of signal to be measured.

**NOTE:** The user is recommended to use the Spectrum Analyzer to determine actual frequency and to observe the spectrum of signal. **Spurious signals >40 dBc can affect the accuracy of the Power Meter.**

11. Press "Zero" Soft Function Key F4 to zero Power Meter. A message appears in a window indicating that the Power Meter is zeroing. Disconnect any RF or DC signal from T/R Connector and press ENTER Key to continue. Another message appears in a window indicating that the zeroing is complete.

**NOTE:** Low Range and High Range Offsets are displayed and are for Factory Use Only.

12. To use an External Loss/Gain Offset:

- Press SETUP Key and move cursor to "11. Set Ext Loss/Gain." Press ENTER Key and use DATA ENTRY Keypad (29) to enter an offset. Press ENTER Key.
- Move cursor to "10. Ext Loss/Gain" and press ENTER Key until **On** appears. Press "Ret" Soft Function Key F5 to return to Power Meter Operation Screen.

**NOTE:** Asterisk (44) appears to the left of meter window when External Loss/Gain is being used to calculate power reading. L/G = XX.X dB (41) appears at lower left corner of screen. XX.X is set value of External Loss/Gain.

STEP

PROCEDURE

---

13. Measure RF Power using Meter Indicator Bar (45) or Digital Readout in W (42) or dBm (49).
14. To store or recall a set of Power Meter parameters, see 4-1-1.
15. To Return to last Operation Screen, press "Ret" Soft Function Key F6.

## 4-8-4 DEVIATION METER (PEAK) OPERATION

Deviation of received FM signals is measured using following procedures:

**NOTE:** The Deviation Meter (Peak) is accessed from Receive Operation Screen, Duplex Operation Screen, Duplex Transmitter Operation Screen or Meter Menu.

Receiver or Duplex Transmitter modulation must be FM for Deviation Meter measurements.

STEP	PROCEDURE
------	-----------

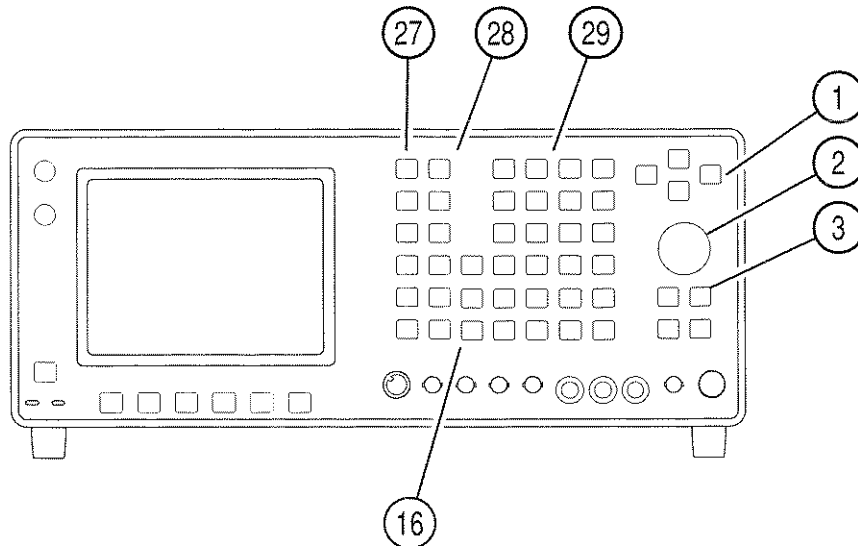

03407016

1. Press RCVR MODE Key (27) to display Receiver Operation Screen or press DPLX MODE Key (27) and "TX" Soft Function Key F1 to display Duplex Transmitter Operation Screen. Press "More" Soft Function Key F6 until "FM Z" Soft Function Key F3 appears. Press "FM Z" Soft Function Key F3 to zero Deviation Meter (Peak). Move cursor to Deviation Meter Callout and press ENTER Key to display Deviation Meter (Peak) Operation Screen.

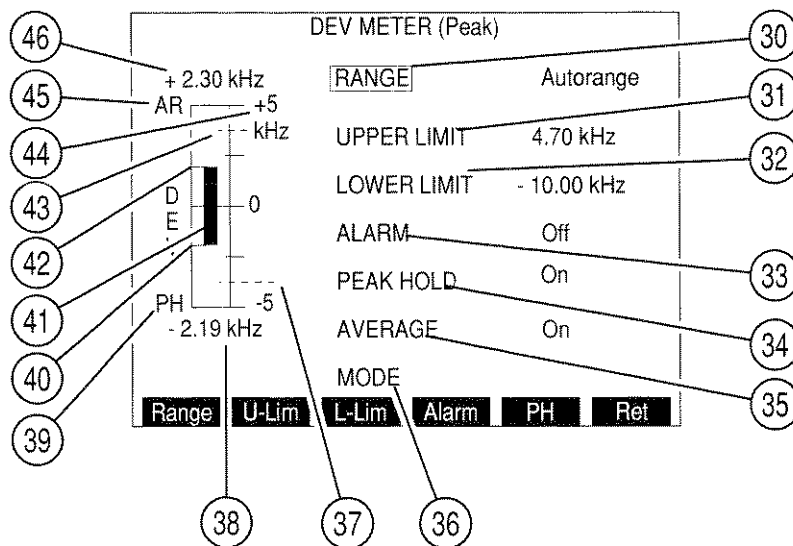

8607072

**NOTE:** "FM Z" Soft Function Key F3 is unavailable when Receiver (or Duplex Transmitter) Modulation is User-defined with bandpass or high pass Post Detection Filter.

2. Move cursor to RANGE (30) and press ENTER Key to access data field. Rotate DATA SCROLL Spinner (2) or press DATA SCROLL ↑ or ↓ Keys (3) to select desired Range and press ENTER Key.
3. Move cursor to UPPER LIMIT (31). Press ENTER Key to activate Upper Limit and access data field. Use DATA ENTRY Keypad (29) to enter desired Upper Limit and press ENTER Key. A blue line (43) appears across meter window marking position of Upper Limit.
4. Move cursor to LOWER LIMIT (32). Press ENTER Key to activate Lower Limit and access data field. Use DATA ENTRY Keypad (29) to enter desired Lower Limit and press ENTER Key. A blue line (37) appears across meter window marking position of Lower Limit.
5. To deactivate Upper or Lower Limit, press SETUP Key to display Deviation Meter (Peak) Menu. Press 3 (Upper Limit) or 5 (Lower Limit) DATA ENTRY Key (29) to toggle Limit Off. Press "Ret" Soft Function Key F5 to return to Deviation Meter (Peak) Operation Screen.
6. Move cursor to ALARM (33) and press ENTER Key to enable or disable Alarm. Enabled Alarm sounds when Upper or Lower Limit is exceeded.
7. Move cursor to PEAK HOLD (34) and press ENTER Key to enable or disable Peak Hold feature of Deviation Meter (Peak). PH (39) appears at lower left of meter window and a Peak Hold indicator (42) and (40) appears on meter indicating highest and lowest point reached by Meter Indicator Bar (41) depending on what Mode (36) is active.
8. Move cursor to AVERAGE (35) and press ENTER Key to enable or disable Deviation Meter Averaging. With Averaging enabled, a running average of last 10 readings are reported.
9. Move cursor to MODE (36) and press ENTER Key. Use DATA SCROLL ↑ and ↓ Keys (3) to select a Mode and press ENTER Key.
10. Measure FM Deviation (Peak) using Meter Indicator Bar (41) or Positive Digital Readout (46) and Negative Digital Readout (38).
11. To store or recall a set of Deviation Meter (Peak) parameters, see 4-1-1.
12. To return to last Operation Screen, press "Ret" Soft Function Key F6.

## 4-8-5 MODULATION METER OPERATION

Received or generated Modulation signals are measured using following procedures:

**NOTE:** The Modulation Meter is accessed from Receive Operation Screen, Duplex Operation Screen, Duplex Transmitter Operation Screen or Meter Menu. The Modulation Meter must be activated in the Receiver Operation Screen for accurate measurements.

STEP	PROCEDURE
------	-----------

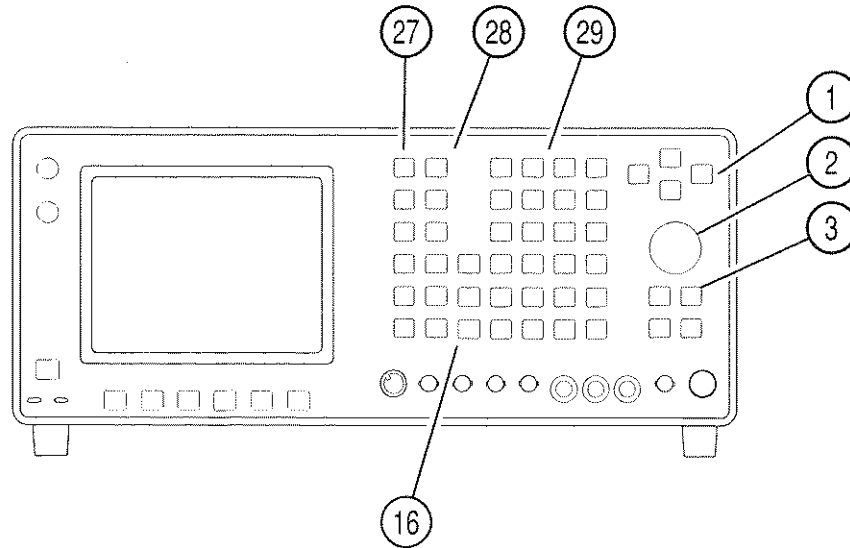

03407016

1. Press RCVR MODE Key (27) to display Receiver Operation Screen or press DPLX MODE Key (27) and "TX" Soft Function Key F1 to display Duplex Transmitter Operation Screen. Verify AM Modulation is in use. Move cursor to Modulation Meter Callout and press ENTER Key to display Modulation Meter Operation Screen.

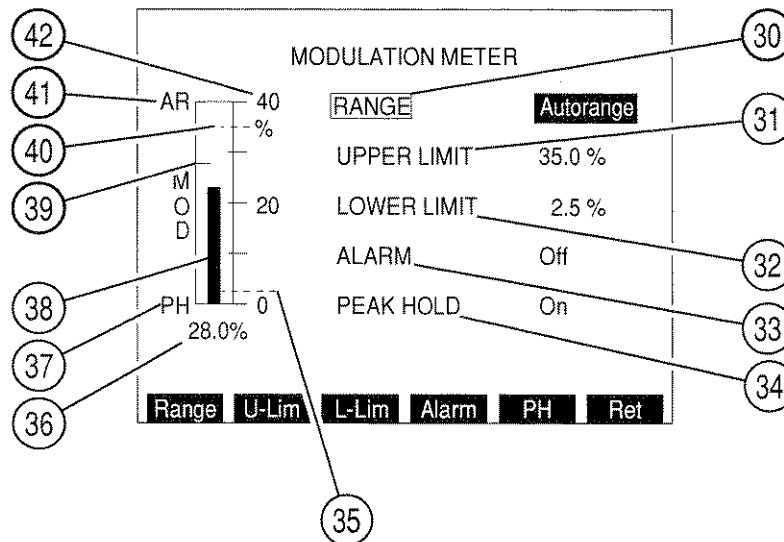

8607073



## STEP

## PROCEDURE

2. Move cursor to RANGE (30) and press ENTER Key to access its data field. Rotate DATA SCROLL Spinner (2) or press DATA SCROLL ↑ or ↓ Keys (3) to select desired Range and press ENTER Key.
3. Move cursor to UPPER LIMIT (31). Press ENTER Key to activate Upper Limit and access data field. Use DATA ENTRY Keypad (29) to enter desired Upper Limit and press ENTER Key. A blue line (40) appears across meter window marking position of Upper Limit.
4. Move cursor to LOWER LIMIT (32). Press ENTER Key to activate Lower Limit and access data field. Use DATA ENTRY Keypad (29) to enter desired Lower Limit and press ENTER Key. A blue line (35) appears across meter window marking position of Lower Limit.
5. To deactivate Upper or Lower Limit, press SETUP Key to display Modulation Meter Menu. Press 3 (Upper Limit) or 5 (Lower Limit) DATA ENTRY Key (29) to toggle Limit Off. Press "Ret" Soft Function Key F5 to return to Modulation Meter Operation Screen.
6. Move cursor to ALARM (33) and press ENTER Key to enable or disable Alarm. Enabled Alarm sounds when Upper or Lower Limit is exceeded.
7. Move cursor to PEAK HOLD (34) and press ENTER Key to enable or disable Peak Hold feature of Modulation Meter. PH (37) appears at lower left of meter window and Peak Hold indicator (39) appears on meter indicating highest point reached by Meter Indicator Bar (38).
8. Measure AM Modulation using Meter Indicator Bar (38) or Modulation Meter Digital Readout (36).
9. To store or recall a set of Modulation Meter parameters, see 4-1-1.
10. To return to last Operation Screen, press "Ret" Soft Function Key F6.

## 4-8-6 DISTORTION METER OPERATION

The distortion of received or generated RF signals is measured using following procedures:

**NOTE:** The Distortion Meter is accessed from RF Generator Operation Screen, Receive Operation Screen, Duplex Operation Screen, Duplex Transmitter Operation Screen, Duplex Receiver Operation Screen or Meter Menu. Meter reflects readings of last Operation Mode of Test Set.

STEP PROCEDURE

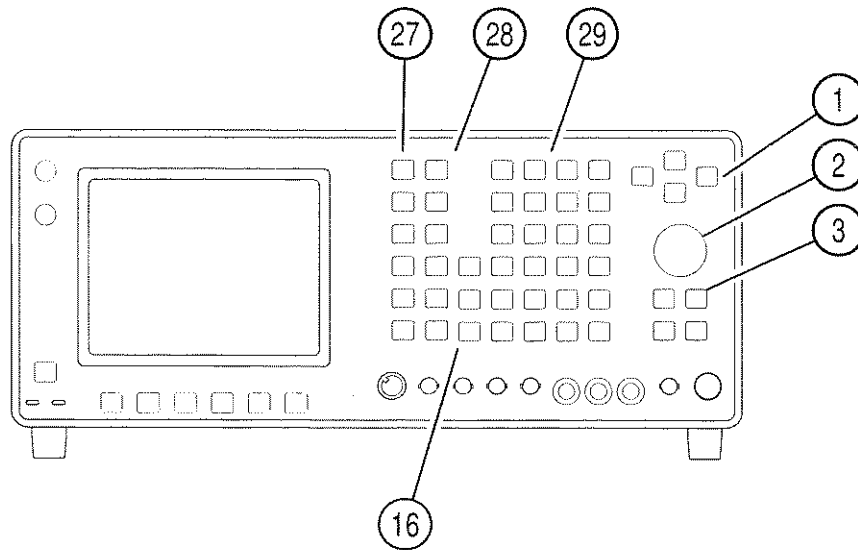

03407016

1. Press MTRS MODE Key (27). Press 6 DATA ENTRY Key (29) to access Distortion Meter Operation Screen.

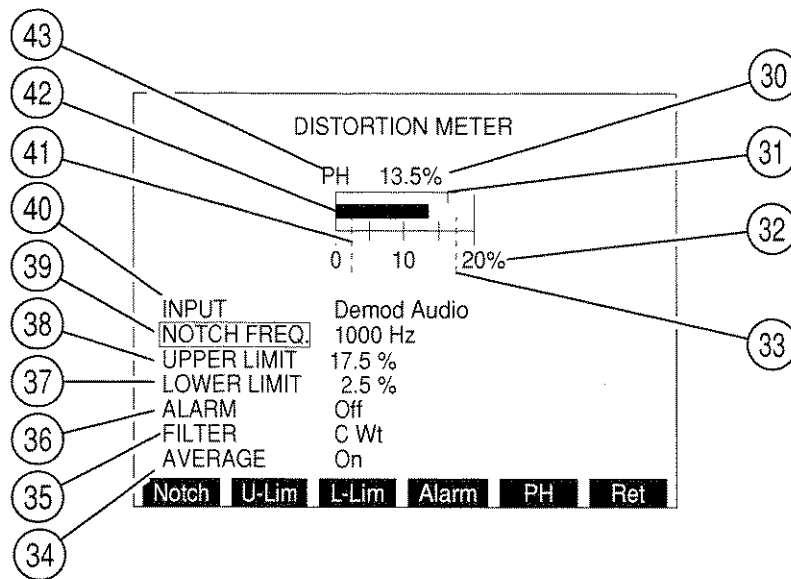

8607074

**NOTE:** When measuring signals <0.6 V through SINAD/BER IN Connector, Receiver squelch must be set to highest level if Receiver is inactive.

2. Move cursor to INPUT (40) and press ENTER Key to access data field. Rotate DATA SCROLL Spinner (2) or press DATA SCROLL ↑ or ↓ Keys (3) until desired selection appears in data field and press ENTER Key to activate Distortion Meter Input.
3. Move cursor to NOTCH FREQ (39) and press ENTER Key to access data field. Use DATA ENTRY Keypad (29) to set Notch frequency and press ENTER Key.
4. Move cursor to UPPER LIMIT (38). Press ENTER Key to activate Upper Limit and access data field. Use DATA ENTRY Keypad (29) to enter Upper Limit and press ENTER Key. A blue line (33) appears across meter window marking position of Upper Limit.
5. Move cursor to LOWER LIMIT (37). Press ENTER Key to activate Lower Limit and access data field. Use DATA ENTRY Keypad (29) to enter Lower Limit and press ENTER Key. A blue line (41) appears across meter window marking position of Lower Limit.
6. To deactivate Upper or Lower Limit, press SETUP Key to display Distortion Meter Menu. Press 4 (Upper Limit) or 6 (Lower Limit) DATA ENTRY Key (29) to toggle Limit Off. Press "Ret" Soft Function Key F5 to return to Distortion Meter Operation Screen.
7. Move cursor to ALARM (36) and press ENTER Key to enable or disable Alarm. Enabled Alarm sounds when Upper or Lower Limit is exceeded.
8. Move cursor to FILTER (35) and press ENTER Key to toggle Filter between C Wt and Low Pass. If Low Pass is selected, Low Pass cutoff frequency appears. Move cursor to Low Pass frequency data field and press ENTER Key. Use DATA ENTRY Keys (29) to enter a cutoff frequency and press ENTER Key.
9. Move cursor to AVERAGE (34) and press ENTER Key to enable or disable Distortion Meter Averaging. With Averaging enabled, a running average of last 10 readings are reported.
10. Press "PH" Soft Function Key F5 to enable or disable Peak Hold feature of Distortion Meter. When enabled, PH (43) appears at upper left of meter window and Peak Hold indicator (31) appears on meter indicating highest point reached by Meter Indicator Bar (42).
11. Measure Percent Distortion using Meter Indicator Bar (42) or Digital Readout (30).
12. To store or recall a set of Distortion Meter parameters, see 4-1-1.
13. To return to last Operation Screen, press "Ret" Soft Function Key F6.

## 4-8-7 SINAD METER OPERATION

SINAD of received or generated RF signals are measured using following procedures:

**NOTE:** The SINAD Meter is accessed from RF Generator Operation Screen, Receive Operation Screen, Duplex Operation Screen, Duplex Transmitter Operation Screen, Duplex Receiver Operation Screen or Meter Menu. Meter reflects readings of last Operation Mode of Test Set.

STEP

PROCEDURE

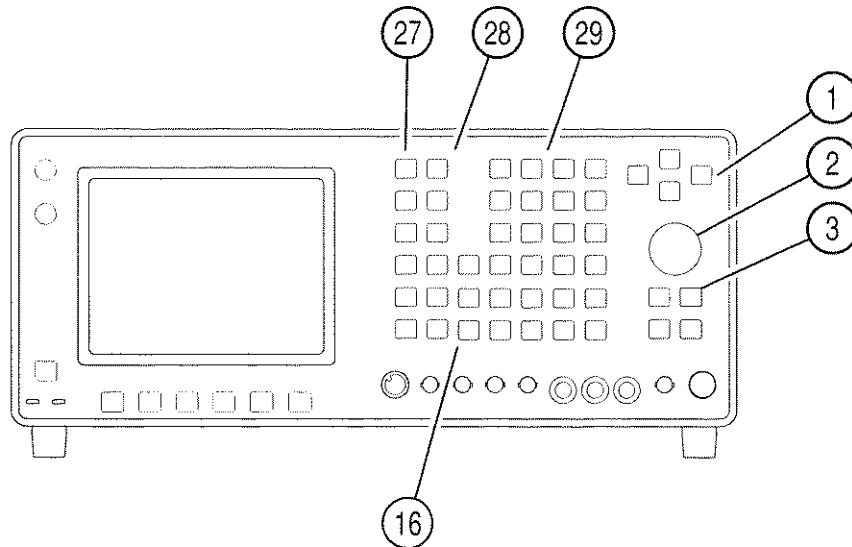

03407016

1. Press MTRS MODE Key (27). Press 7 DATA ENTRY Key (29) to access SINAD Meter Operation Screen.

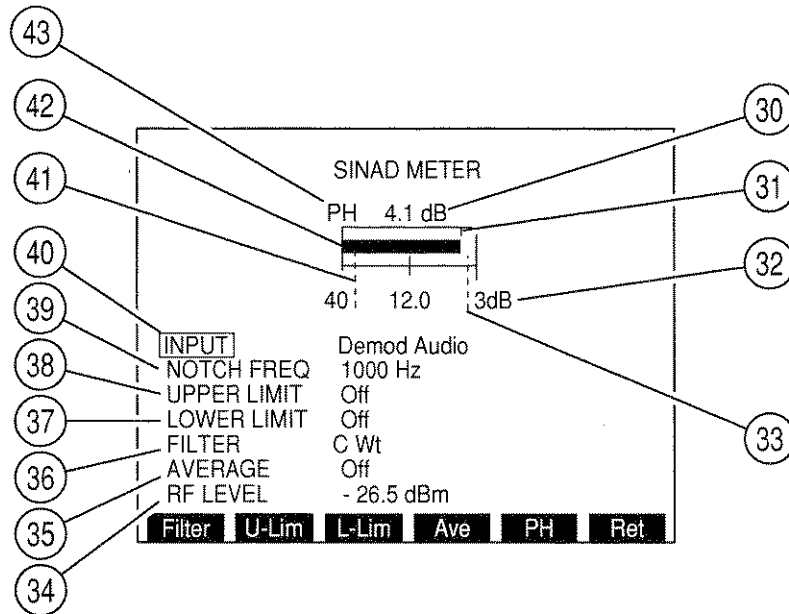

8607075

**NOTE:** When measuring signals  $<0.6$  V through SINAD/BER IN Connector, Receiver squelch must be set to highest level if Receiver is inactive.

2. Move cursor to INPUT (40) and press ENTER Key to access data field. Rotate DATA SCROLL Spinner (2) or press DATA SCROLL  $\uparrow$  or  $\downarrow$  Keys (3) until desired selection appears in data field and press ENTER Key to activate Distortion Meter Input.
3. Move cursor to NOTCH FREQ (39) and press ENTER Key to access data field. Use DATA ENTRY Keypad (29) to set Notch frequency and press ENTER Key.
4. Move cursor to UPPER LIMIT (38). Press ENTER Key to activate Upper Limit and access data field. Use DATA ENTRY Keypad (29) to enter Upper Limit and press ENTER Key. A blue line (33) appears across meter window marking position of Upper Limit.
5. Move cursor to LOWER LIMIT (37). Press ENTER Key to activate Lower Limit and access data field. Use DATA ENTRY Keypad (29) to enter Lower Limit and press ENTER Key. A blue line (41) appears across meter window marking position of Lower Limit.
6. To deactivate Upper or Lower Limit, press SETUP Key to display SINAD Meter Menu. Press 4 (Upper Limit) or 6 (Lower Limit) DATA ENTRY Key (29) to toggle Limit Off. Press "Ret" Soft Function Key F5 to return to SINAD Meter Operation Screen.
7. Move cursor to FILTER (36) and press ENTER Key to toggle Filter between C Wt and Low Pass. If Low Pass is selected, Low Pass cutoff frequency appears. Use FIELD SELECT Keys (1) to move cursor to Low Pass frequency data field and press ENTER Key. Use DATA ENTRY Keypad (29) to enter a cutoff frequency and press ENTER Key.
8. Press SETUP Key and move cursor to "10. Readout Res." Press ENTER Key to toggle Digital Readout resolution to .1 dB or .5 dB. Press "Ret" Soft Function Key F5.
9. Move cursor to AVERAGE (35) and press ENTER Key to enable or disable SINAD Meter Averaging. With Averaging enabled, a running average of last 10 readings are reported.
10. If RF Generator or Duplex Receiver Operation Screen is last Operation Screen accessed, RF LEVEL (34) appears. Move cursor to RF LEVEL (34) and press ENTER Key. Use DATA ENTRY Keypad (29) to select RF Generator Level or Duplex Receiver Output Level and press ENTER Key.
11. Press "PH" Soft Function Key F5 to enable or disable Peak Hold feature of SINAD Meter. When enabled, PH (43) appears at upper left of meter window and Peak Hold indicator (31) appears on meter indicating highest point reached by Meter Indicator Bar (42).
12. Measure SINAD using Meter Indicator Bar (42) or Digital Readout (30).
13. To store or recall a set of SINAD Meter parameters, see 4-1-1.
14. To return to last Operation Screen, press "Ret" Soft Function Key F6.

## 4-8-8 SIGNAL STRENGTH METER OPERATION

Signal Strength measurements of signals received at ANTENNA IN Connector (25) are measured using the following procedures:

**NOTE:** Signal Strength Meter is accessed from Receiver Operation Screen, Duplex Operation Screen, Duplex Transmitter Operation Screen or Meter Menu. Meter reflects readings of last Operation Mode of Test Set.

STEP	PROCEDURE
------	-----------

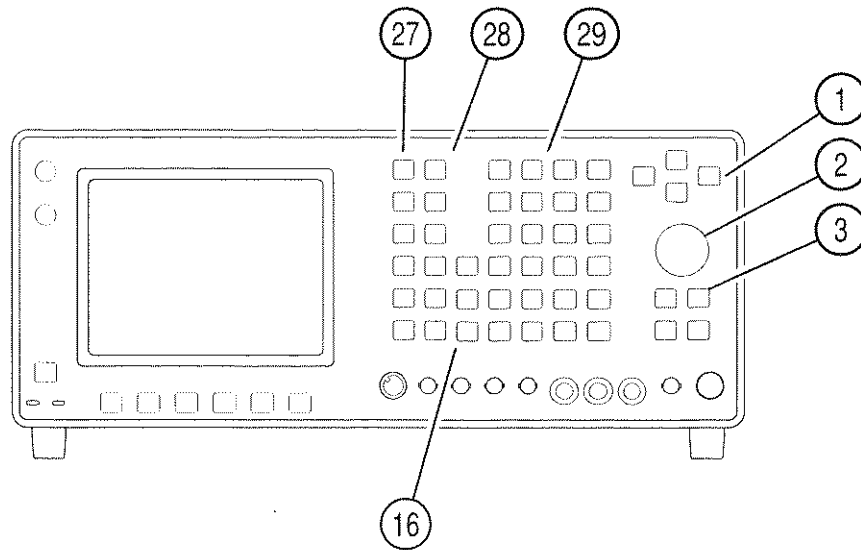

03407016

1. Press MTRS MODE Key (27). Press 8 DATA ENTRY Key (29) to access Signal Strength Meter Operation Screen.

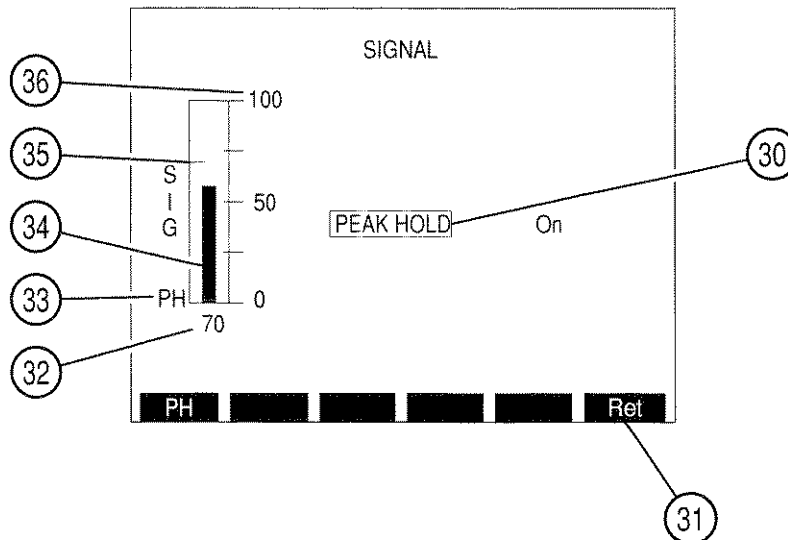

8607105

**STEP****PROCEDURE**

---

2. Move cursor to PEAK HOLD (30) and press ENTER Key to enable or disable Peak Hold feature of Signal Strength Meter. PH (33) appears at lower left of meter window and Peak Hold indicator (35) appears on meter indicating highest point reached by Meter Indicator Bar (34).
3. Measure Signal Strength readings using Meter Indicator Bar (34) or Signal Strength Digital Readout (32).
4. To store or recall a set of Signal Strength Meter parameters, see 4-1-1.
5. To return to last Operation Screen, press "Ret" Soft Function Key F6.

## 4-8-9 BIT ERROR RATE (BER) METER OPERATION

The Bit Error Rate Meter is operated using the following procedures:

STEP PROCEDURE

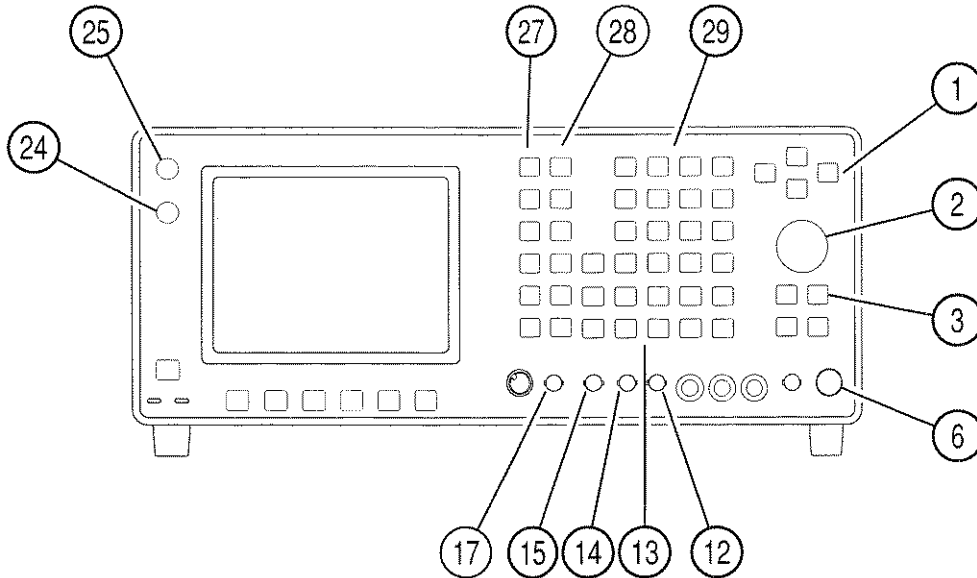

03407018

1. Press MTRS MODE Key (27). Meter Menu appears. Press 9 DATA ENTRY Key (29) to access BER Meter Operation Screen.

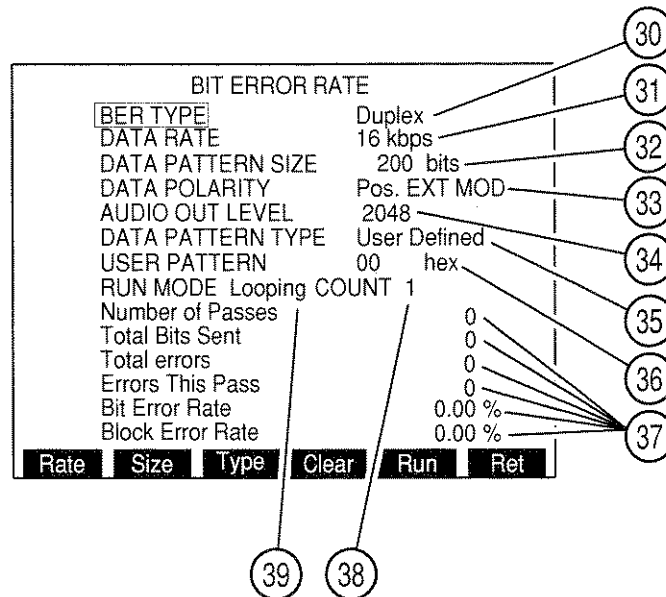

8607076

2. Move cursor to BER TYPE (30) and press ENTER Key. BER TYPE Submenu appears. Use DATA ENTRY Keypad (29) to select a BER Type.

**NOTE:** The BER Type determines Operation Mode of BER Meter. Each BER Type has a separate Setup Menu.



**NOTE:** With Receiver BER Type, test data is sent through AUDIO OUT Connector (14) to be modulated by UUT. UUT Output returns to ANTENNA IN Connector (25) or T/R Connector (6) of Test Set and is demodulated and compared to original test data.

With Generator BER Type, modulated test data is sent through T/R Connector (6) to UUT to be demodulated. Demodulated data is received by Test Set at SINAD/BER IN Connector (15) (inverted) or EXT MOD IN Connector (17) and compared with original test data.

With Baseband BER Type, test data is sent through AUDIO OUT Connector (14) to be modulated and then demodulated by UUT. Demodulated UUT output is received by Test Set at SINAD/BER IN Connector (15) (inverted) or EXT MOD IN Connector (17) and compared to original test data.

With Duplex BER Type, modulated test data is sent through T/R Connector (6) or DUPLEX OUT Connector (24) to UUT to be demodulated and then modulated. This signal is received at ANTENNA IN Connector (25) or T/R Connector (6), demodulated by Test Set and compared to original test data.

3. If Receiver is selected as BER Type, proceed with Step 4. If Generator is selected as BER Type, proceed with Step 11. If Duplex is selected as BER Type, proceed with Step 18. If Baseband is selected as BER Type, proceed with Step 30.
4. For Receiver BER Type, press SETUP Key to display Receiver BER Meter Menu:

#### RECEIVER BER METER MENU

BER METER MENU	
1. Ber Type	Receiver
2. Set Rcvr Freq	10.0000 MHz
3. Select Mod	FM
4. Select Rcvr In	Antenna
5. Select Input Atten	0 dB
6. Audio Out Level	2048

8610094

5. Press 2 DATA ENTRY Key (29) and use DATA ENTRY Keypad (29) to enter Receiver Frequency. Press ENTER Key.

6. Press 3 DATA ENTRY Key (29) to access Modulation Menu:

RECEIVER BER MODULATION MENU

BER METER MENU	
1. Ber Type	Receiver
2. Set Rcvr Freq	999.0000 MHz
3. Select Mod	FM DATA
4. Set 1. Modulation	FM DATA
5. Set 2. IF Filters	30 kHz
6. Au 3. Post Detection	Low Pass

8610095

- Press 1 DATA ENTRY Key (29) and use DATA ENTRY Keypad (29) to select a Modulation Type.
  - Press 2 DATA ENTRY Key (29) and use DATA ENTRY Keypad (29) to select IF Filter.
  - Press 3 DATA ENTRY Key (29) and use DATA ENTRY Keypad (29) to select a Post Detection Filter. If a data field appears, use DATA ENTRY Keypad (29) to select cutoff frequencies and press ENTER Key.
  - Press "ESC" Soft Function Key F6.
7. Press 4 DATA ENTRY Key (29) to toggle Receiver Input to either ANTENNA IN Connector (25) or T/R Connector (6).
  8. Press 5 DATA ENTRY Key (29) and use DATA ENTRY Keypad (29) to select an Input Attenuation.
  9. Press 6 DATA ENTRY Key (29) and use DATA ENTRY Keypad to enter an Audio Out Level.
  10. Press "Ret" Soft Function Key F5 to return to BER Operation Screen. Proceed with Step 30.
  11. For Generator BER Type, press SETUP Key to access Generator BER Meter Menu:

GENERATOR BER METER MENU

BER METER MENU	
1. Ber Type	Generator
2. RF Gen Freq	10.0000 MHz
3. RF Gen Level	- 20.0 dBm
4. RF Gen Level Units	dBm
5. RF Gen Mod	FM
6. RF Gen Mod Level	4.0 kHz

Ret ESC

8610372

## STEP

## PROCEDURE

12. Press 2 DATA ENTRY Key (29). Use DATA ENTRY Keypad (29) to set RF Generator Frequency and press ENTER Key.
13. Press 3 DATA ENTRY Key (29). Use DATA ENTRY Keypad (29) to set RF Generator Level and press ENTER Key.
14. Press 4 DATA ENTRY Key (29) to toggle RF Generator Units between dBm and volts.
15. Press 5 DATA ENTRY Key (29). Use DATA ENTRY Keypad (29) to select RF Generator Modulation and press ENTER Key.
16. Press 6 DATA ENTRY Key (29). Use DATA ENTRY Keypad (29) to select RF Generator Modulation Level and press ENTER Key.
17. Press "Ret" Soft Function Key F5 to return to BER Meter Operation Screen. Proceed with Step 30.
18. For Duplex BER Type, press Setup Key to display Duplex BER Meter Menu.
19. Press 2 DATA ENTRY Key (29) and use DATA ENTRY Keypad (29) to set Receiver Frequency and press ENTER Key.
20. Press 3 DATA ENTRY Key (29) to access Modulation Submenu:

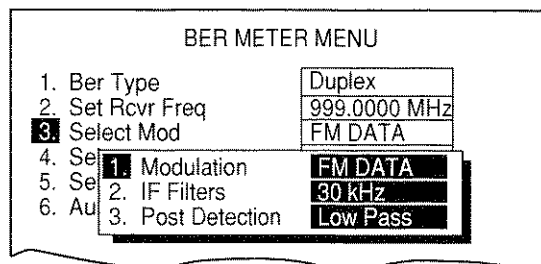

8610172

- Press 1 DATA ENTRY Key (29) and use DATA ENTRY Keypad (29) to select a Modulation Type.
  - Press 2 DATA ENTRY Key (29) and use DATA ENTRY Keypad (29) to select an IF Filter Type.
  - Press 3 DATA ENTRY Key (29) and use DATA ENTRY Keypad (29) to select a Post Detection Filter. If a data field appears, use DATA ENTRY Keypad (29) to select cutoff frequencies and press ENTER Key.
  - Press "ESC" Soft Function Key F6.
21. Press 4 DATA ENTRY Key (29) to toggle Receiver Input to either Antenna or T/R.
  22. Press 5 DATA ENTRY Key (29) and use DATA ENTRY Keypad (29) to select an Input Attenuation.
  23. Press 6 DATA ENTRY Key (29). Use DATA ENTRY Keypad (29) to set RF Generator Frequency and press ENTER Key.

## STEP

## PROCEDURE

- 
24. Press 7 DATA ENTRY Key (29). Use DATA ENTRY Keypad (29) to set RF Generator Level and press ENTER Key.
  25. Press 8 DATA ENTRY Key (29) to toggle RF Generator Units to either dBm or volts.
  26. Press 9 DATA ENTRY Key (29). Use DATA ENTRY Keypad (29) to select RF Generator Modulation and press ENTER Key.
  27. Move cursor to "10. RF Gen Mod Level" and press ENTER Key. Use DATA ENTRY Keypad (29) to set RF Generator Modulation Level and press ENTER Key.
  28. Move cursor to "11. RF Gen Output" and press ENTER Key to toggle RF Generator Output to either Duplex or T/R.
  29. Press "Ret" Soft Function Key F5 to return to BER Meter Operation Screen.
  30. Move cursor to DATA RATE (31) and press ENTER Key. DATA RATE Submenu appears. Use DATA ENTRY Keys (29) to select a Data Rate.  
**NOTE:** If 16 kbps is selected, user is recommended to set IF Filter to 300 kHz and Post Detection Filter to Low-Pass (15 kHz cutoff) for Receiver or Duplex Transmitter Operation.
  31. Move cursor to DATA PATTERN SIZE (32) and press ENTER Key. DATA PATTERN SIZE data field highlights. Use DATA ENTRY Keypad (29) to enter Data Pattern Size (100 through 100000) and press ENTER Key.
  32. Move cursor to DATA POLARITY (33) and press ENTER Key. Use DATA SCROLL ↑ or ↓ Keys (3) to toggle polarity between "Pos. EXT MOD and "Neg. SINAD/BER." Press ENTER Key to activate selection.
  33. If Receiver or Baseband is selected as BER Type (30), move cursor to AUDIO OUT LEVEL (34) and press ENTER Key. Use DATA ENTRY Keys (29) to set Audio Out Level and press ENTER Key.
  34. If Duplex or Generator is selected as BER Type (30), move cursor to RF GEN LEVEL (34) and press ENTER Key. Use DATA ENTRY Keys (29) to set RF Generator Level and press ENTER Key.
  35. Move cursor to DATA PATTERN TYPE (35) and press ENTER Key. DATA PATTERN TYPE Submenu appears. Use DATA ENTRY Keypad (29) to select a Data Pattern Type.
  36. If "3. User Defined" is selected as DATA PATTERN TYPE (35), USER PATTERN (36) appears:
    - Move cursor to USER PATTERN (36) and press ENTER Key. User Pattern data field is highlighted.
    - Use DATA ENTRY Keypad (29) and SHIFT Key to enter desired pattern in hex digits and press ENTER Key.**NOTE:** If "1. Random" or "2. Fixed" is selected as DATA PATTERN TYPE (35), USER PATTERN (36) and User Pattern data field is unavailable.

- 
37. Move cursor to RUN MODE (39) and press ENTER Key. RUN MODE Submenu appears. Use DATA ENTRY Keypad (29) to select a Run Mode.
- For Continuous RUN MODE (39), press “Run” Soft Function Key F5. Soft Function Key F5 becomes “Stop”. BER Test runs continually until “Stop” Soft Function Key F5 is pressed.
  - For One Shot RUN MODE (39), press “Run” Soft Function Key F5 to run BER Test once. Press “Stop” Soft Function Key F5 to stop BER Test before completion.
  - For Loop RUN MODE (39), COUNT (38) appears. Move cursor to COUNT and use DATA ENTRY Keypad (29) to select number of passes for BER Test. Press ENTER Key. Press “Run” Soft Function Key F5 to start BER Test. Press “Stop” Soft Function Key F5 to stop BER Test before specified passes are completed.
38. Press “Clear” Soft Function Key F4 to reset BER Meter readouts to 0.
39. The BER Meter readouts (37) are interpreted in following manner:
- Number of Passes  
Displays number of BER Test passes. One pass consists of a block containing DATA PATTERN SIZE (32) number of bits.
  - Total Bits Sent  
Displays total number of bits sent including all passes of BER Tests since last clearing of readouts.
  - Total Errors  
Displays total number of errors including all passes of BER Tests since last clearing of readouts.
  - Errors This Pass  
Displays number of errors for last pass. One pass consists of a block containing DATA PATTERN SIZE (32) number of bits.
  - Bit Error Rate  
Displays percentage of total number of bits that are in error.
  - Block Error Rate  
Displays percentage of blocks containing at least one error. A block contains DATA PATTERN SIZE (32) number of bits.

## 4-8-10 DIGITAL MULTIMETER OPERATION

The Digital Multimeter is operated using the following procedures:

STEP	PROCEDURE
------	-----------

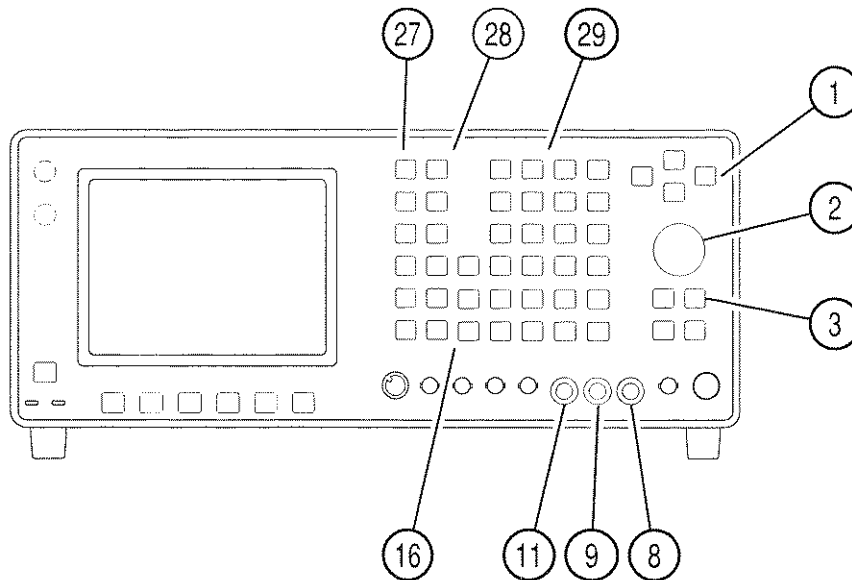

03407019

1. Press MTRS MODE Key (27). Meter Menu appears. Use FIELD SELECT ↑ or ↓ Keys (1) to move cursor to "10. Digital Multimeter" and press ENTER Key. Digital Multimeter Operation Screen appears:

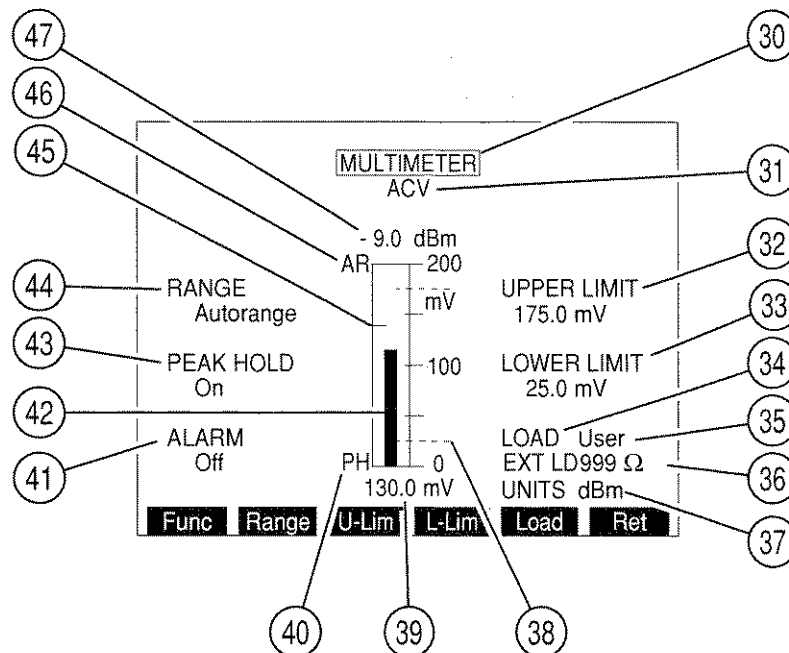

03416043

2. Move cursor to MULTIMETER (30) and press ENTER Key to access MULTIMETER data field (31). Press DATA SCROLL ↑ or ↓ Keys (3) until desired Multimeter Function appears in data field and press ENTER Key.

## STEP

## PROCEDURE

3. Install DMM Probes on Front Panel using following DMM Connectors for indicated DMM Function.
  - Voltage Measurements:  $V\Omega$  (11) and COM (9)
  - Current Measurement: AMP (8) and COM (9)
  - Ohmmeter:  $V\Omega$  (11) and COM (9)

**CAUTION:** APPLY NO MORE THAN 30 VRMS THROUGH DMM  $V\Omega$  CONNECTOR. CURRENT INPUT MORE THAN 2 A REQUIRES CURRENT SHUNT BETWEEN DMM PROBES AND  $V\Omega$  AND COM CONNECTORS WITH RANGE (44) SET TO 20 A.
4. Move cursor to RANGE (44) and press ENTER Key to access the data field. Use DATA SCROLL  $\uparrow$  or  $\downarrow$  Keys (3) to select a Range and press ENTER Key.
5. Move cursor to PEAK HOLD (43) and press ENTER Key to toggle Peak Hold Feature between On and Off. PH (40) appears at lower left of Meter window and Peak Hold indicator (45) appears indicating highest point reached by Meter Indicator Bar (42).
6. Move cursor to ALARM (41) and press ENTER Key to enable or disable Alarm. Enabled Alarm sounds when Upper or Lower Limit is exceeded.
7. Move cursor to UPPER LIMIT (32). Press ENTER Key to activate Upper Limit and access its data field. Use DATA ENTRY Keypad (29) to enter Upper Limit and press ENTER Key. A blue line appears across meter window marking position of Upper Limit. Upper Limit must be < highest value of current range to operate correctly.
8. Move cursor to LOWER LIMIT (33) and press ENTER Key to activate Lower Limit and access its data field. Use DATA ENTRY Keypad (29) to enter Lower Limit and press ENTER Key. A blue line (38) appears across meter window marking position of Lower Limit. Lower Limit must be < highest value of current range to operate correctly.
9. To deactivate Upper or Lower Limits, press SETUP Key to display Multimeter Menu. Press 4 (Upper Limit) or 6 (Lower Limit) DATA ENTRY Key (29) to toggle Limit Off. Press "Ret" Soft Function Key F5 to return to Digital Multimeter Operation Screen.
10. If "ACV" is selected as Multimeter Function:
  - Move cursor to LOAD (34) and press ENTER Key to access LOAD data field (35). Press DATA SCROLL  $\uparrow$  and  $\downarrow$  Keys (3) until desired load appears in data field and press ENTER Key.
  - If User is selected as Load, move cursor to EXT LD (36) and press ENTER Key. Use DATA ENTRY Keys (29) to set External Load and press ENTER Key.

**NOTE:** External Load must be installed externally by operator.
  - If LOAD (34) selected is not 1 MEG, UNITS (37) appears. Move cursor to UNITS (48) and press ENTER Key to toggle units between "dBm" and "Watts." Setting determines the units displayed by dBm/W Digital Reading (47).

**STEP****PROCEDURE**

---

11. Connect DMM Probes to UUT test points and observe Meter Indicator Bar (42) and Digital Meter Readout (39). IF DMM input exceeds maximum allowed input while using ACV or DCV Function, beeps are sounded and Meter Indicator Bar is displayed red until DMM input is reduced to acceptable levels.
12. To store or recall a set of Multimeter parameters, see 4-1-1.



## 4-8-11 PHASE METER OPERATION

Received or generated Phase Modulation signals are measured using following procedures:

**NOTE:** The Phase Meter is accessed from Receive Operation Screen, Duplex Operation Screen, Duplex Transmitter Operation Screen or Meter Menu. Meter reflects readings of last Operation Mode of Test Set.

The Receiver or Duplex Transmitter Modulation must be set to PM for measurements by the Phase Meter.

STEP

PROCEDURE

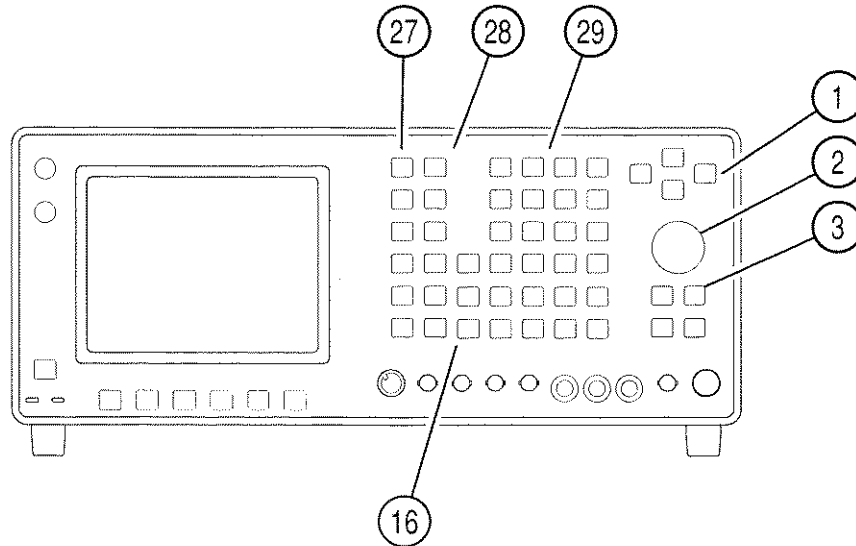

03407016

1. Press MTRS MODE Key (27). Meter Menu appears. Use FIELD SELECT  $\uparrow$  or  $\downarrow$  Keys (1) to move cursor to "11. Phase Meter" and press ENTER Key. Phase Meter Operation Screen appears:

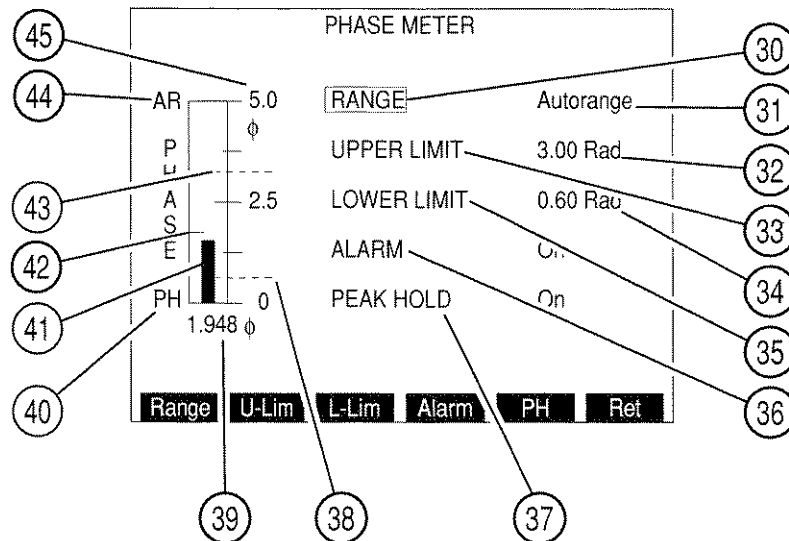

03416044

## STEP

## PROCEDURE

- 
2. Move cursor to RANGE (30) and press ENTER Key to access data field (31). Press DATA SCROLL ↑ or ↓ Keys (3) to select desired Range and press ENTER Key.
  3. Move cursor to UPPER LIMIT (33). Press ENTER Key to activate Upper Limit and access data field. Use DATA ENTRY Keypad (29) to enter desired Upper Limit and press ENTER Key. A blue line (43) appears across meter window marking position of Upper Limit.
  4. Move cursor to LOWER LIMIT (35). Press ENTER Key to activate Lower Limit and access data field. Use DATA ENTRY Keypad (29) to enter desired Lower Limit and press ENTER Key. A blue line (38) appears across meter window marking position of Lower Limit.
  5. To deactivate Upper or Lower Limit, press SETUP Key to display Phase Meter Menu. Press 3 (Upper Limit) or 5 (Lower Limit) DATA ENTRY Key (29) to toggle Limit Off. Press "Ret" Soft Function Key F5 to return to Phase Meter Operation Screen.
  6. Move cursor to ALARM (36) and press ENTER Key to enable or disable Alarm. Enabled Alarm sounds when Upper or Lower Limit is exceeded.
  7. Move cursor to PEAK HOLD (37) and press ENTER Key to enable or disable Peak Hold feature of Phase Meter. PH (40) appears at lower left of meter window and Peak Hold indicator (42) appears on meter indicating highest point reached by Meter Indicator Bar.
  8. Measure Phase Modulation using Meter Indicator Bar (41) or Digital Readout (39).
  9. To store or recall a set of Phase Meter parameters, see 4-1-1.
  10. To return to last Operation Screen, press "Ret" Soft Function Key F6.

## 4-8-12 DEVIATION METER (RMS) OPERATION

RMS Deviation of received FM signals is measured using the following procedures:

**NOTE:** Deviation Meter (RMS) is accessed from Receive Operation Screen, Duplex Transmitter Operation Screen or Meter Menu.

Receiver or Duplex Transmitter modulation must be FM for Deviation Meter (RMS) measurements.

Deviation Meter (RMS) may provide invalid readings with Deviation Meter (Peak) Range >10 kHz.

STEP

PROCEDURE

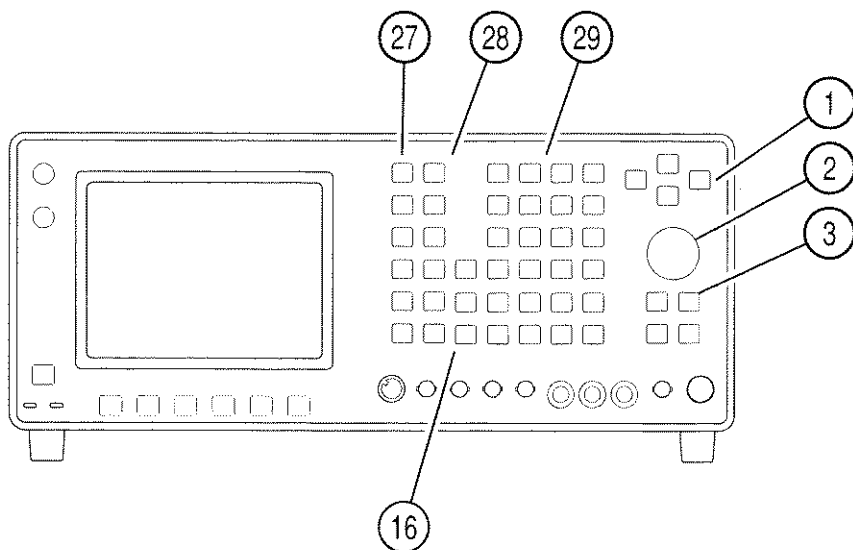

03407016

1. Press RCVR MODE Key (27) to display Receiver Operation Screen or press DPLX MODE Key (27) and "TX" Soft Function Key F1 to display Duplex Transmitter Operation Screen.
2. Press "More" Soft Function Key F6 until "Meters" Soft Function Key F4 appears. Press "Meters" Soft Function Key F4 and press 3 DATA ENTRY Key (29). Move cursor to Deviation Meter (RMS) Callout and press ENTER Key to display Deviation Meter (RMS) Operation Screen.

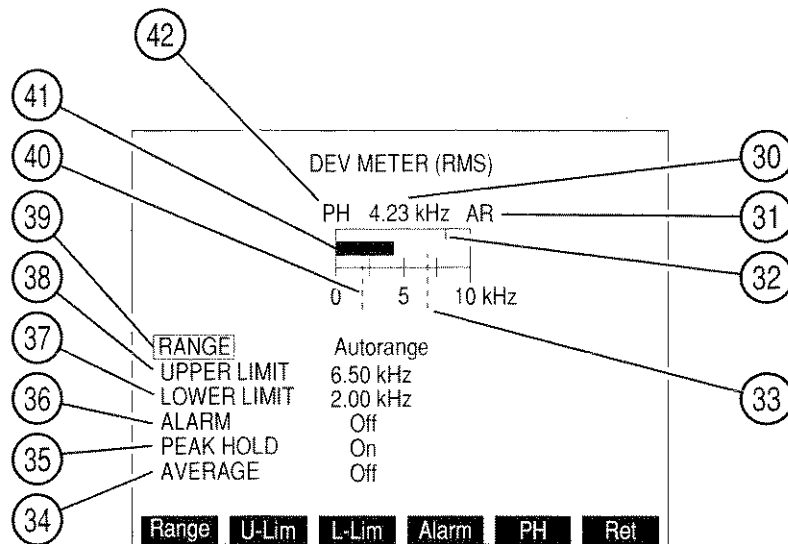

8607122

3. Move cursor to RANGE (39) and press ENTER Key to access data field. Rotate DATA SCROLL Spinner (2) or press DATA SCROLL ↑ or ↓ Keys (3) to select desired Range and press ENTER Key.
4. Move cursor to UPPER LIMIT (38). Press ENTER Key to activate Upper Limit and access data field. Use DATA ENTRY Keypad (29) to enter desired Upper Limit and press ENTER Key. A blue line (33) appears across meter window marking position of Upper Limit.
5. Move cursor to LOWER LIMIT (37). Press ENTER Key to activate Lower Limit and access data field. Use DATA ENTRY Keypad (29) to enter desired Lower Limit and press ENTER Key. A blue line (40) appears across meter window marking position of Lower Limit.
6. To deactivate Upper or Lower Limits, press SETUP Key to display Deviation Meter (RMS) Menu. Press 3 (Upper Limit) or 5 (Lower Limit) DATA ENTRY Key (29) to toggle Limit Off. Press "Ret" Soft Function Key F5 to return to Deviation Meter (RMS) Operation Screen.
7. Move cursor to ALARM (36) and press ENTER Key to enable or disable Alarm. Enabled Alarm sounds when Upper or Lower Limit is exceeded.
8. Move cursor to PEAK HOLD (35) and press ENTER Key to enable or disable Peak Hold feature of Deviation Meter (RMS). PH (42) appears at upper left of meter window and Peak Hold indicator (32) appears on meter indicating highest point reached by Meter Indicator Bar (41).
9. Move cursor to AVERAGE (34) and press ENTER Key to enable or disable Deviation Meter (RMS) Averaging. With Averaging enabled, a running average of last 10 readings are reported.
10. Measure FM RMS Deviation using Meter Indicator Bar (41) or Digital Readout (30).
11. To store or recall a set of Deviation Meter (RMS) parameters, see 4-1-1.
12. To return to last Operation Screen, press "Ret" Soft Function Key F6.

### 4-8-13 PHASE METER (RMS) OPERATION

RMS phase modulation readings of received PM signals is measured using the following procedures:

**NOTE:** Phase Meter (RMS) is accessed from Receive Operation Screen, Duplex Transmitter Operation Screen or Meter Menu.

Receiver or Duplex Transmitter modulation must be PM for Phase Meter (RMS) measurements.

STEP	PROCEDURE
------	-----------

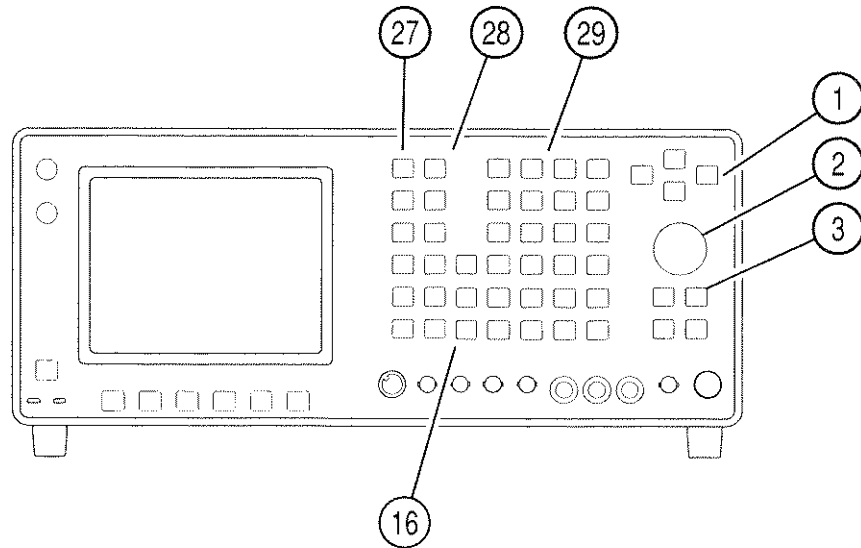

03407016

1. Press RCVR MODE Key (27) to display Receiver Operation Screen or press DPLX MODE Key (27) and "TX" Soft Function Key F1 to display Duplex Transmitter Operation Screen.
2. Press "More" Soft Function Key F6 until "Meters" Soft Function Key F4 appears. Press "Meters" Soft Function Key F4 and press 3 DATA ENTRY Key (29). Move cursor to Phase Meter (RMS) Callout and press ENTER Key to display Phase Meter (RMS) Operation Screen.

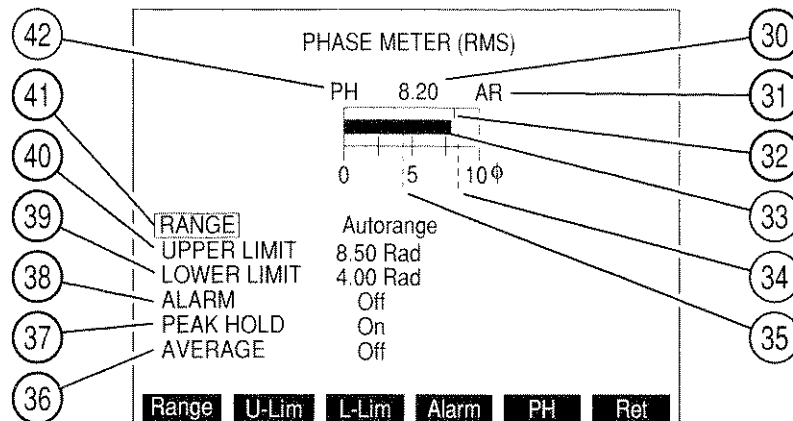

8607331

3. Move cursor to RANGE (41) and press ENTER Key to access data field. Rotate DATA SCROLL Spinner (2) or press DATA SCROLL  $\uparrow$  or  $\downarrow$  Keys (3) to select desired Range and press ENTER Key.
4. Move cursor to UPPER LIMIT (40). Press ENTER Key to activate Upper Limit and access data field. Use DATA ENTRY Keypad (29) to enter desired Upper Limit and press ENTER Key. A blue line (34) appears across meter window marking position of Upper Limit.
5. Move cursor to LOWER LIMIT (39). Press ENTER Key to activate Lower Limit and access data field. Use DATA ENTRY Keypad (29) to enter desired Lower Limit and press ENTER Key. A blue line (35) appears across meter window marking position of Lower Limit.
6. To deactivate Upper or Lower Limits, press SETUP Key to display Phase Meter (RMS) Menu. Press 3 (Upper Limit) or 5 (Lower Limit) DATA ENTRY Key (29) to toggle Limit Off. Press "Ret" Soft Function Key F5 to return to Phase Meter (RMS) Operation Screen.
7. Move cursor to ALARM (38) and press ENTER Key to enable or disable Alarm. Enabled Alarm sounds when Upper or Lower Limit is exceeded.
8. Move cursor to PEAK HOLD (37) and press ENTER Key to enable or disable Peak Hold feature of Phase Meter (RMS). PH (42) appears at upper left of meter window and Peak Hold indicator (32) appears on meter indicating highest point reached by Meter Indicator Bar (33).
9. Move cursor to AVERAGE (36) and press ENTER Key to enable or disable Phase Meter (RMS) Averaging. With Averaging enabled, a running average of last 10 readings are reported.
10. Measure PM RMS readings using Meter Indicator Bar (33) or Digital Readout (30).
11. To store or recall a set of Phase Meter (RMS) parameters, see 4-1-1.
12. To return to last Operation Screen, press "Ret" Soft Function Key F6.

## 4-8-14 AUDIO FREQUENCY LEVEL METER (RMS) OPERATION

RMS level readings of audio frequency input signal at SINAD/BER IN Connector (15) are measured using the following procedures:

**NOTE:** Audio Frequency (AF) Level Meter (RMS) is accessed from RF Generator Operation Screen, Duplex Receiver Operation Screen or Meter Menu.

STEP	PROCEDURE
------	-----------

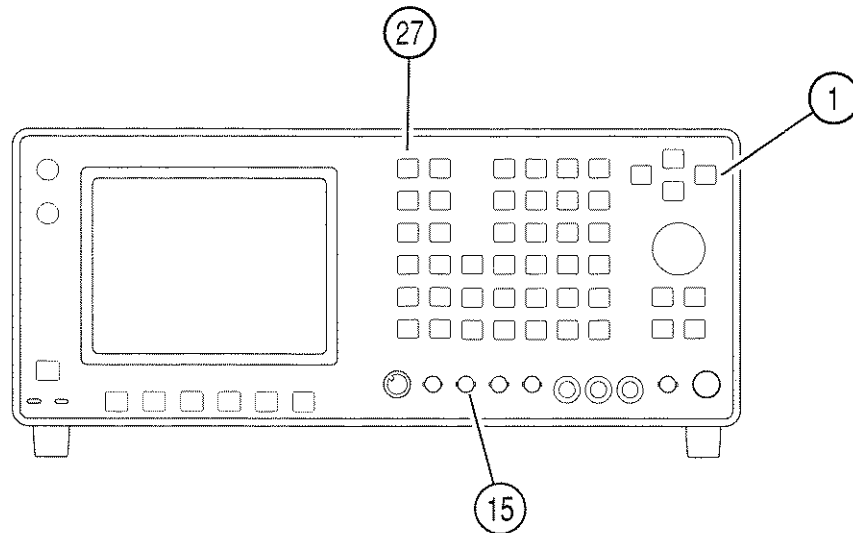

03407020

1. Press MTRS Key (27). Meter Menu appears. Use FIELD SELECT  $\uparrow$  or  $\downarrow$  Keys (1) to move cursor to "14. AF Level Meter (RMS)" and press ENTER Key. AF Level Meter (RMS) Operation Screen appears:

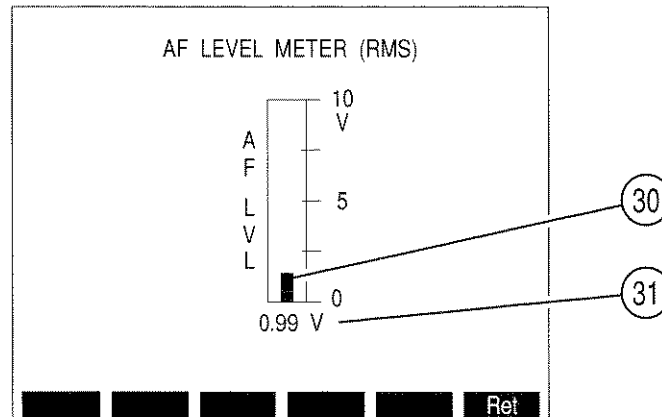

8607333

2. Measure AF Level Meter (RMS) readings using Meter Indicator Bar (30) or Digital Readout (31).
3. To return to last Operation Screen, press "Ret" Soft Function Key F6.

# SECTION 5 - PERFORMANCE EVALUATION

## 5-1 GENERAL

This section contains information on test procedures for assessing the performance of the IFR-1900. All tests conducted are self tests performed by the unit. No additional equipment is needed to conduct these tests. For maximum benefit, the operator should be thoroughly familiar with all aspects of this manual before performing these procedures.

## 5-2 POWER-UP SELF TEST

When power is switched on to the IFR-1900, the unit performs a power-up self test. A 1-2-4 beep series sounds if unit is functioning normally and the IFR Logo Screen is displayed. An abnormality causes a break in this sequence or an error message to be displayed on the screen. If an error message occurs, switch power off, wait thirty seconds and power unit on again. If error reoccurs, refer unit to maintenance for corrective action.

## 5-3 SELF TEST

A more thorough check of the IFR-1900 is provided by a user-requested self test. The Self Test is accessible from the Auxiliary Functions Menu. Refer to 3-3-10 for more information on the Auxiliary Functions Menu. From the Auxiliary Functions Menu, select "4. Self Test." This selection displays the Self Test Menu in Figure 5-1.

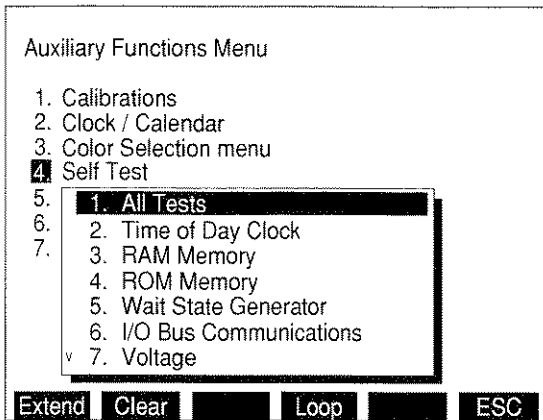

Figure 5-1 Self Test Menu

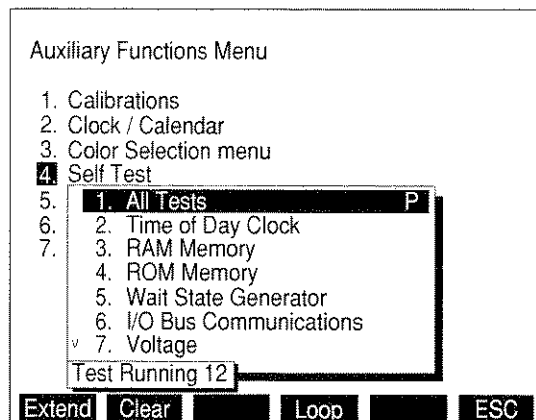

Figure 5-2 Test Running Counter

The Self Test Menu is composed of 23 individual tests and "All Tests" which, when selected, performs each of the individual tests, automatically. Seven of these items are visible at one time. Access to other parts of the Self Test Menu is available by using the DATA SCROLL Keys (3) (Figure 3-1). The DATA SCROLL ↑ and ↓ Keys (3) (Figure 3-1) scroll the menu up and down one item at a time. The DATA SCROLL ← Key (4) functions as a page up key and the DATA SCROLL → Key (4) functions as a page down key.

To initiate a complete Self Test, ensure cursor is on "1. All Tests" and press the ENTER Key. A "Test Running" prompt appears with current test number displayed as shown in Figure 5-2.



"All Tests" performs each of the individual tests and returns a result of "P" for pass or "F" for fail as shown in Figures 5-3 and 5-4. An "All Tests" failure occurs with even one individual test failure. If "All Tests" fails, examine the entire menu to determine specific test failures. An "F" prompt is visible to the right of a test which has failed as shown in Figure 5-5.

**NOTE:** Failure of a specific test may lead to failure in other specific tests although the other portions being tested may be operating properly.

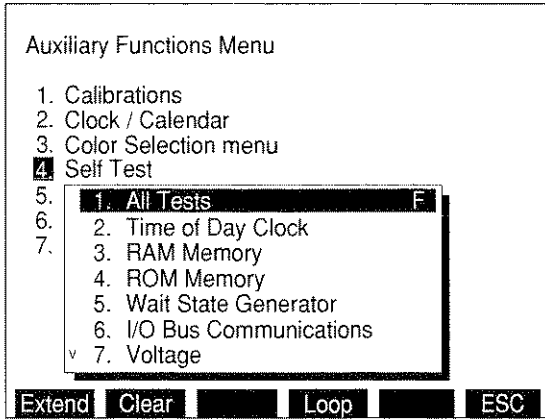

Figure 5-3 "All Tests" Failure

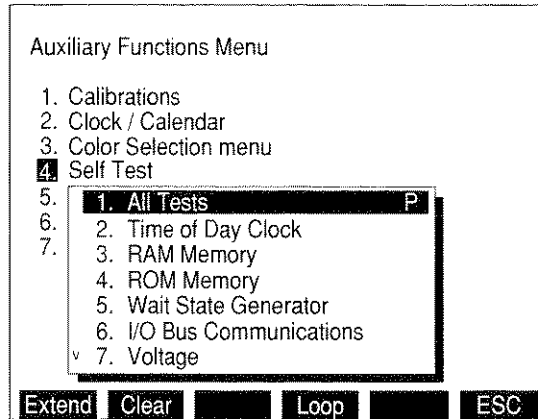

Figure 5-4 "All Tests" Pass

An individual test can be activated by moving cursor to desired test and pressing the ENTER Key. The result of an individual test is returned as "P" for pass or "F" for fail.

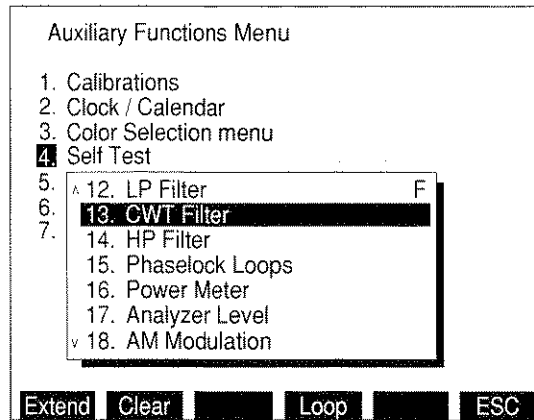
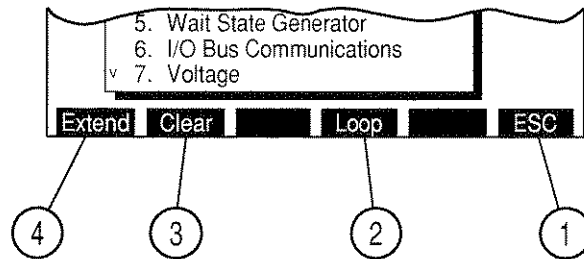

Figure 5-5 Individual Test Failure

Various Soft Function Keys are defined for use with the Self Test. The Self Test Soft Function Keys are displayed and defined as follows:

ITEM	DESCRIPTION
------	-------------



8610068

1. “ESC” Soft Function Key

Exits user from current submenu level to next higher menu.

2. “Loop” Soft Function Key

Activates currently designated test. Test repeats until failure or until “Stop” Soft Function Key (5) is selected. Can be used with Self Test or any individual test.

3. “Clear” Soft Function Key

Erases all test results displayed.

4. “Extend” Soft Function Key

Used on individual tests. If test is composed of multiple tests, “Extend” allows each subtest to be performed and result obtained separately. On some tests, use of “Extend” displays numeric measurement associated with test or information concerning the nature of a failure (e.g. In the event of an I/O Bus Communications failure, the specific bus with a problem would be indicated). On tests where neither of the above apply, selection activates the test and returns “Pass” or “Fail” as a result.

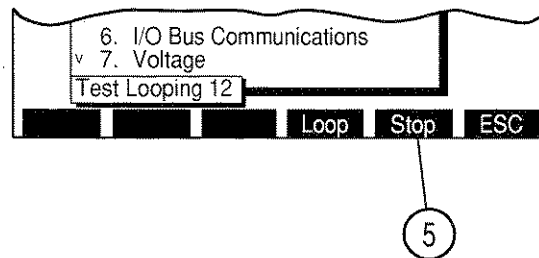

8610067

5. “Stop” Soft Function Key

Discontinues “Loop” function. Displays “P” or “F.”

# SECTION 6 - REMOTE OPERATION

## 6-1 GENERAL

The IFR-1900 is designed to operate remotely through a Host System as an external controller. All data available through Front Panel Operation is available through the Host System. The Host System (a PC using terminal emulation software or an RS-232 terminal) can generate any command available except Power On.

Remote Operation can be performed using the HOST RS-232 Connector or the GPIB Connector. Refer to Appendix A for pin-out information. Location of both connectors is shown in Figure 3-2. Remote operation depends on having IFR-1900 settings match user equipment and interface settings. Settings in operating procedures may require variation depending on user equipment

**NOTE:** The operation of OPT. RS-232 Connector (if present on the rear panel of the IFR-1900) is described in the IFR-1900 CSA Option Operation Manual.

It is important that the operator be familiar with this manual and the Front Panel Operation of the IFR-1900 before initiating Remote Operations. Refer to Section 3, as needed, for information regarding Controls, Connectors, Indicators, Operation Screens and Menus. The operator must take care in programming the IFR-1900 remotely. An illegal command, normally ignored by the Front Panel, might be executed remotely.

## 6-2 REMOTE OPERATING PROCEDURES

The IFR-1900 can be remotely operated utilizing the HOST RS-232 or GPIB Connectors.

Reference the Sections indicated in Table 6-1 for each associated connector:



REAR PANEL CONNECTOR	REFERENCE
<p style="text-align: center;">HOST RS-232</p> 	<ul style="list-style-type: none"> <li>● Section 6-2-1, Remote Operation using Host System</li> <li>● Section 6-2-2, Remote Operation using Modem</li> <li>● Section 6-2-3, Operating IFR-1900 as RS-232 Terminal</li> </ul>
<p style="text-align: center;">IEEE 488</p> 	<ul style="list-style-type: none"> <li>● Section 6-2-4, Remote Operation using GPIB</li> </ul>
<p style="text-align: center;">OPT. RS-232</p> 	<ul style="list-style-type: none"> <li>● See IFR-1900 CSA Option Operation Manual</li> </ul>

Table 6-1 Rear Panel I/O Connector By Section

Perform the following operating procedures for Remote Operation of the IFR-1900.

## 6-2-1 REMOTE OPERATION USING HOST SYSTEM (RS-232)

### STEP PROCEDURE

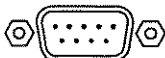
1. Connect external control device to IFR-1900 as shown below:

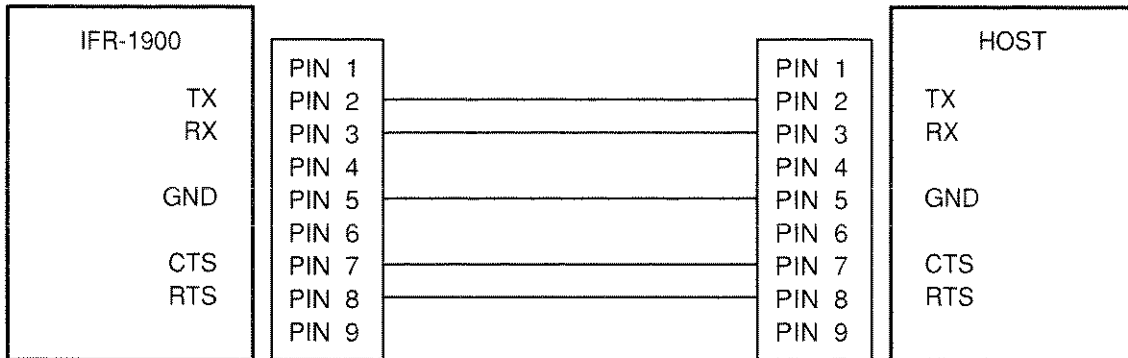

03403007

2. Perform the following keystrokes:

- MTRS MODE Key (27).
- "AUX" Soft Function Key F6 (displays Auxiliary Functions Menu).
- 5 DATA ENTRY Key (29) (displays External I/O Menu).
- 1 DATA ENTRY Key (29) (displays Configure RS-232 Menu).

3. Press 1 DATA ENTRY Key (29) to access RS-232 Operation Mode. Press 2 DATA ENTRY Key (29) to select **Host**.

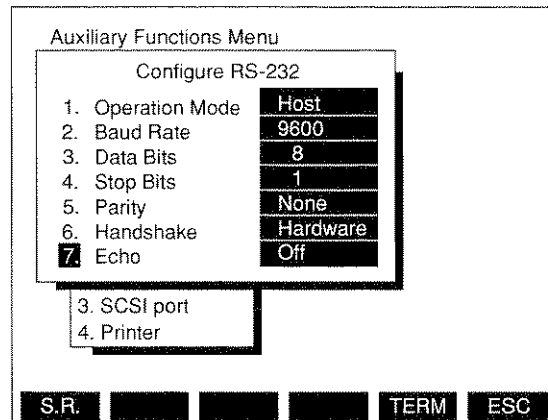

8616013

4. Press 2 DATA ENTRY Key (29) to access Baud Rate Submenu. Use DATA ENTRY Keys (29) to select desired Baud Rate.
5. Press 3 DATA ENTRY Key (29) until Data Bits toggles to **8**.

STEP

PROCEDURE

6. Press 4 DATA ENTRY Key (29) until Stop Bits toggles to **1**.
7. Press 5 and 1 DATA ENTRY Keys (29) to select **None** for Parity.
8. Press 6 and 3 DATA ENTRY Keys (29) to select **Xon/Xoff** Handshaking.
9. Press 7 DATA ENTRY Key (29) until Echo is toggled **Off** (when faster action is desired) or **On** (when displaying transmission is desired).
10. Set Terminal Emulator Software or RS-232 Terminal parameters as shown in Table 6-2.

PARAMETER	SETTING
Baud Rate	Same as IFR-1900
Data Bits	8
Stop Bits	1
Parity	None
Handshaking	Xon/Xoff

Table 6-2 Terminal Settings for RS-232 Host Operation

11. Set Duplex or Echo mode as desired.
12. Press any MODE Key (27) to exit setup.
13. Perform any the following actions as desired:
  - Send commands from Host terminal to IFR-1900.
  - Write and save macros using Host System text editor.
  - Transfer macros and programs to IFR-1900 using Host System.

6-2-2 REMOTE OPERATION USING MODEM (RS-232)

The IFR-1900 can be connected to a Modem and operated remotely over the telephone line.

STEP

PROCEDURE

1. Connect Modem to HOST RS-232 Connector on the IFR-1900 rear panel as shown below:

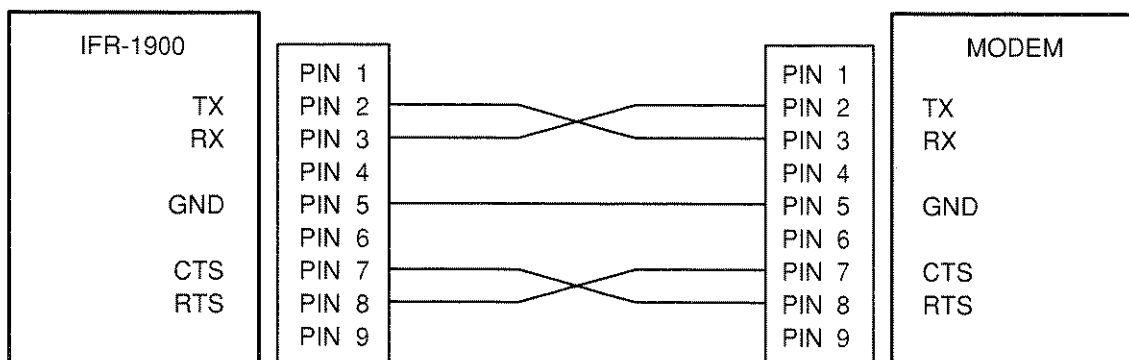

03403008

## STEP

## PROCEDURE

2. Perform Steps 2 and 3 of Section 6-2-1.
3. Press 2 DATA ENTRY Key (29) to access Baud Rate Submenu. Set Baud Rate as desired, according to Modem requirements.
4. Press 3 DATA ENTRY Key (29) until Data Bits toggles to **8**.
5. Press 4 DATA ENTRY Key (29) until Stop Bits toggles to **1**.
6. Press 5 and 1 DATA ENTRY Keys (29) to select **None** for Parity.
7. Press 6 and 1 DATA ENTRY Keys (29) to select **None** for Handshaking.
8. Press 7 DATA ENTRY Key (29) until Echo is toggled **Off**.
9. Press "ESC" Soft Function Key F6 twice to return to the Auxiliary Functions Menu.
10. Press "TERM" Soft Function Key F5 to access RS-232 Monitor Screen.
11. Use DATA ENTRY Keys (29) to enter attention prefix and dialing command of Modem.
12. Operate IFR-1900 from destination telephone number.

## 6-2-3 OPERATING IFR-1900 AS RS-232 TERMINAL

The IFR-1900 can be used as an RS-232 Terminal.

## STEP

## PROCEDURE

1. Connect Test Equipment to HOST RS-232 Connector on IFR-1900 rear panel as shown below:

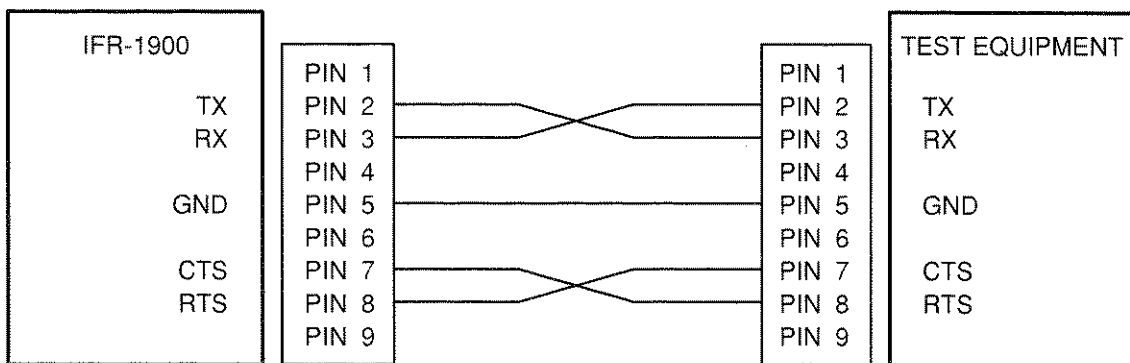

03403009

2. Perform Steps 2 and 3 of Section 6-2-1.
3. Press 2 DATA ENTRY Key (29) to access Baud Rate Submenu. Set Baud Rate as desired, according to Test Equipment requirements.
4. Press 3 DATA ENTRY Key (29) until Data Bits toggles to **8**.
5. Press 4 DATA ENTRY Key (29) until Stop Bits toggles to **1**.
6. Press 5 and 1 DATA ENTRY Keys (29) to select **None** for Parity.
7. Press 6 and 3 DATA ENTRY Keys (29) to select **Xon/Xoff** for Handshaking.
8. Press 7 DATA ENTRY Key (29) until Echo is toggled **On**.

## STEP

## PROCEDURE

9. Press "ESC" Soft Function Key F6 twice to return to Auxiliary Functions Menu.
10. Set Test Equipment parameters as specified in Table 6-2.
11. Press "TERM" Soft Function Key F5 to access RS-232 Monitor Screen.
12. Use DATA ENTRY Keys (29) to enter commands. Use SHIFT Key to toggle between numeric and alphabetic keys. Use Soft Function Keys to enter additional special characters.
13. To exit RS-232 Monitor Screen, press any MODE Key (27).

## 6-2-4 REMOTE OPERATION USING GPIB

The IFR-1900 can be remotely operated using GPIB protocol. The IFR-1900 can be operated on the same GPIB with other devices (including the internal CSA Option) using separate addresses.

## STEP

## PROCEDURE

1. Perform the following keystrokes:
  - MTRS MODE Key (27).
  - "AUX" Soft Function Key F6 (displays Auxiliary Functions Menu).
  - 5 DATA ENTRY Key (29) (displays External I/O Menu).
  - 2 DATA ENTRY Key (29) (displays Configure GPIB Menu).

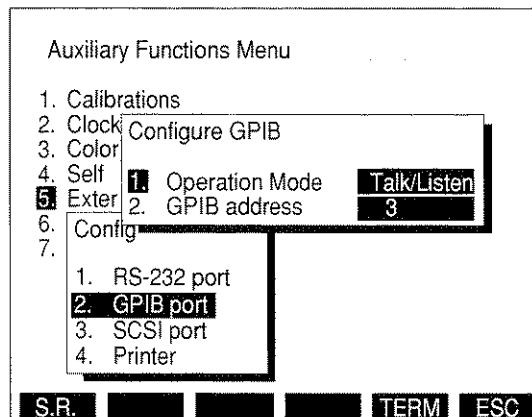

8816015

2. Press 1 DATA ENTRY Key (29) to access GPIB Operation Mode. Use DATA ENTRY Keypad (29) to select operation Mode. Select **Talk/Listen** to operate IFR-1900 from GPIB Controller. Select **Controller** to operate other test equipment from the IFR-1900.
3. Press 2 DATA ENTRY Key (29) to access GPIB address. Use DATA ENTRY Keypad (29) to select a unique address on the GPIB. **Avoid address conflicts with any other device connected to GPIB.**

**NOTE:** The CSA Option, if installed, must have a separate GPIB address from that of the IFR-1900.

4. Connect GPIB cable to GPIB Connector on IFR-1900 Rear Panel.
5. Initiate parallel remote operation.

### **6-3 TMAC (TEST MACRO LANGUAGE)**

TMAC is used to remotely operate the IFR-1900 and provide a format to store and perform user defined test sequences. TMAC is based on the IEEE-488.2 format and also supports the SCPI Standard.

One of TMAC's main strengths is the capability to define macros. This allows step by step test procedures to be developed, stored and remotely implemented. Flow control commands allow decision making and looping within the macro. TMAC also provides a variety of data structures to assist in developing test procedures. Developing macros is made easier by allowing a macro to execute by entering the macro name and its parameters. Macros can be executed from other macros with parameters being passed from one macro to the other, allowing complicated procedures to be divided into smaller tasks. Multitasking commands allow several macros to alternate command execution, giving the appearance of being executed simultaneously.

A full explanation of the TMAC Language is beyond the scope of this manual. Table 6-5 lists the specific instrument commands. For a complete explanation of the TMAC Language including the use of macros, variables, data structures, flow control commands and multitasking commands, see the IFR-1900 TMAC Users Manual.



## 6-4 COMMAND SYNTAX

TMAC structures commands hierarchically through the use of the colon (:) delimiter. This concept allows the command paths to be formulated using common key sequences (e.g., To set either of the generator frequencies, :GEN:FREQ 1000 or :RX:FREQ 1000 are employed). Both the generator family of commands and receiver family of commands have common key words.

To allow access to the command paths, the IFR-1900 interpreter keeps track of the current path or command level where it expects to find the next command. The current path is determined by using a set of rules. On power-up or after a \*RST command, the unit sets the current path to the root command node. This is the highest level of the command tree structure. Also, the end of a message or command line resets the current path to the root node.

When a colon is used as the delimiter between commands, the current path is moved down one level in the command structure (e.g., The colon in GEN:FREQ specifies that FREQ is one level down from GEN). When a colon is used as the first character of a command, it specifies that the command is to be found at the root node. A semicolon is used to separate multiple commands in the same message line. A semicolon does not change the current path.

For example:

```
:FGEN:DATA:STAT ON;BILVL;DEV 5600;ATT 0;RATE 1600;FLT:OUT
```

is equivalent to:

```
:FGEN:DATA:STAT ON  
:FGEN:DATA:BILVL  
:FGEN:DATA:DEV 5600  
:FGEN:DATA:ATT 0  
:FGEN:DATA:RATE 1600  
:FGEN:DATA:FLT:OUT
```

Commands with multiple parameter fields separate the parameters with a comma (,). An example of a multiple parameter command is: :SCOP:TRACE:GET? 9,200. At least one space is needed between commands and parameters, other spaces or lack of them do not affect the command. This command is also an example of a query command, where the operator is requesting data from the IFR-1900. Query commands contain a question mark (?) at the end of the command and before any parameters.

Commands are entered using a short or a long form. The short form is shown in upper case, the remainder of the long form is shown in lower case.

Various Command Syntax punctuation marks are shown in Table 6-3.

PUNCTUATION MARK	NAME	DESCRIPTION
;	Message Separator	Used to separate commands on same line.
:	Compound Command Separator	Allows hierarchy of command structure.
,	Parameter Separator	Separates parameters in multiple parameter command line.
?	Query Command Ending	Requests return of data.
\	End of Line Continuation	Allows command to continue on next line. Command words must remain intact.

Table 6-3 Command Syntax Punctuation Marks

## 6-5 MANDATORY IEEE 488.2 COMMANDS

In compliance with IEEE-488.2 1987, Table 6-4 lists reserved commands for remote operations. When these commands are used, they must include the leading asterisk (\*).

MNEMONIC	COMMAND
*CLS	Clear Status Command
*DDT	Define Device Trigger Command
*DDT?	Define Device Trigger Query
*DMC	Define Macro Command
*EMC x	Enable Macro Command
*EMC?	Enable Macro Command Status Query
*ESE	Standard Event Status Enable
*ESE?	Standard Event Status Enable Query
*ESR?	Standard Event Status Register Query
*IDN?	Identification Query
*LMC?	List Macro Query
*OPC	Operation Complete Command
*OPC?	Operation Complete Query
*OPT?	Returns Software Option of Test Set
*PMC	Purge (delete) Macros Command
*RCL x	Recall Command
*RST	Restart Command
*SAV x	Save Command
*SRE	Service Request Enable Command
*SRE?	Service Request Enable Query
*STB?	Read Status Byte Query
*TRG	Initiate Trigger Command
*TST?	Self Test Query
*WAI	Wait-to-continue

Table 6-4 Mandatory GPIB Commands

## 6-6 IFR-1900 SPECIFIC COMMANDS

Table 6-5 lists specific instrument commands for IFR-1900. These commands are broken out by operation type such as Deviation Meter or Oscilloscope commands. These commands are complete commands except where user must determine a parameter. This field is shown in command line as x. All possible values or value ranges are listed for commands requiring parameters. For simplicity, boolean values are limited to 0 and 1.

COMMAND	RANGE/VALUE	DESCRIPTION
<b>AUDIO FREQUENCY METER COMMANDS</b>		
:M_AF:RANGe:UPPer x	.2, 2, 20 or 200	Sets Frequency Range of Audio Frequency Meter in kHz.
:M_AF:RANGe:AUTO		Enables Autorange of Audio Frequency Meter.
:M_AF:UL:STATe x	0 or OFF, 1 or ON	Toggles Upper Limit of Audio Frequency Meter on or off.
:M_AF:UL:LEVel x	0.0000 to 200.0000	Sets Upper Limit Level of Audio Frequency Meter in kHz.
:M_AF:LL:STATe x	0 or OFF, 1 or ON	Toggles Lower Limit of Audio Frequency Meter on or off.
:M_AF:LL:LEVel x	0.0000 to 200.0000	Sets Lower Limit Level of Audio Frequency Meter in kHz.
:M_AF:ALARM x	0 or OFF, 1 or ON	Enables/Disables Over/Under Limit Alarm of Audio Frequency Meter.
:M_AF:PH x	0 or OFF, 1 or ON	Enables/Disables Peak Hold of Audio Frequency Meter.
:M_AF:RESolution x	1 or 0.1 Hz	Sets Audio Frequency Meter resolution.
:M_AF:STORE x	1 to 9	Stores parameters of Audio Frequency Meter at indicated Store Parameters Menu location.
:M_AF:RCL x	1 to 9	Recalls parameters of Audio Frequency Meter from indicated Recall Parameters Menu location.
:M_AF:INPut:XAUDio		Selects External Audio Input for Audio Frequency Meter.
:M_AF:INPut:DEMOD		Selects Demod Audio Input for Audio Frequency Meter.
:M_AF:INPut:FGEN		Selects Function Generator Input for Audio Frequency Meter.

Table 6-5 IFR-1900 Specific Commands

COMMAND	RANGE/VALUE	DESCRIPTION
:M_AF:INPut:SINAD		Selects SINAD Input for Audio Frequency Meter.
:M_AF:INPut:BER		Selects BER Input for Audio Frequency Meter.
:M_AF:INPut:POWer		Selects RF Power Input for Audio Frequency Meter.
:M_AF:FILTer:LPASs:STATe x		Enables/Disables Low-Pass Filter.
:M_AF:FILTer:LPASs:STATe?		Queries Low-Pass Filter state.
:M_AF:FILTer:LPASs:FREQuency x	0.1 to 30.0 kHz.	Sets Low-Pass Filter frequency.
:M_AF:FILTer:LPASs:FREQuency?		Queries Low-Pass Filter frequency.
:M_AF:FILTer:HPASs:STATe x		Enables/Disables High-Pass Filter.
:M_AF:FILTer:HPASs:STATe?		Queries High-Pass Filter state.
:M_AF:FILTer:HPASs:FREQuency x	0.5 to 20.0 kHz.	Sets High-Pass Filter frequency.
:M_AF:FILTer:HPASs:FREQuency?		Queries High-Pass Filter frequency.
:M_AF?		Returns Audio Frequency Meter reading in Hz.
:M_AF:PEAK?		Returns Audio Frequency Meter Peak reading in Hz.
<b>RADIO FREQUENCY ERROR METER COMMANDS</b>		
:M_RF:RANGe:UPPer x	0.1, 1, 10 or 100	Sets Frequency Range of Radio Frequency Error Meter in kHz.
:M_RF:RANGe:AUTO		Enables Autorange of Radio Frequency Error Meter.
:M_RF:UL:STATe x	0 or OFF, 1 or ON	Toggles Upper Limit of Radio Frequency Error Meter on or off.
:M_RF:UL:LEVel x	0.0000 to 100.0000	Sets Upper Limit Level of Radio Frequency Error Meter in kHz.
:M_RF:LL:STATe x	0 or OFF, 1 or ON	Toggles Lower Limit of Radio Frequency Error Meter on or off.
:M_RF:LL:LEVel x	0.0000 to 100.0000	Sets Lower Limit Level of Radio Frequency Error Meter in kHz.

Table 6-5 IFR-1900 Specific Commands (cont)

COMMAND	RANGE/VALUE	DESCRIPTION
:M_RF:ALARM x	0 or OFF, 1 or ON	Enables/Disables Over/Under Limit Alarm of Radio Frequency Error Meter.
:M_RF:PH x	0 or OFF, 1 or ON	Enables/Disables Peak Hold of Radio Frequency Error Meter.
:M_RF:RESolution x	1 or 10	Sets Radio Frequency Error Meter resolution in Hz.
:M_RF:STORe x	1 to 9	Stores parameters of Radio Frequency Error Meter at indicated Store Parameters Menu location.
:M_RF:RCL x	1 to 9	Recalls parameters of Radio Frequency Meter from indicated Recall Parameters Menu location.
:M_RF?		Requests return of Radio Frequency Error Meter reading in Hz.
:M_RF:PEAK?		Requests return of Radio Frequency Error Meter Peak reading in Hz.
<b>POWER METER COMMANDS</b>		
:M_PWR:RANGe:UPPer x	.02, .05, .10, .2, .5, 1, 2, 5, 10, 20, 50, 100 or 200	Sets Range Value of Power Meter in Watts.
:M_PWR:RANGe:AUTO		Enables Autorange of Power Meter.
:M_PWR:UL:STATe x	0 or OFF, 1 or ON	Toggles Upper Limit of Power Meter on or off.
:M_PWR:UL:LEVel x	0.0000 to 200.0000	Sets Upper Limit Level of Power Meter in Watts.
:M_PWR:LL:STATe x	0 or OFF, 1 or ON	Toggles Lower Limit of Power Meter on or off.
:M_PWR:LL:LEVel x	0.0000 to 200.0000	Sets Lower Limit Level of Power Meter in Watts.
:M_PWR:ALARM x	0 or OFF, 1 or ON	Enables/Disables Over/Under Limit Alarm of Power Error Meter.
:M_PWR:PH x	0 or OFF, 1 or ON	Enables/Disables Peak Hold of Power Meter.

Table 6-5 IFR-1900 Specific Commands (cont)

COMMAND	RANGE/VALUE	DESCRIPTION
:M_PWR:STOREx	1 to 9	Stores parameters of Power Meter at indicated Store Parameters Menu location.
:M_PWR:RCLx	1 to 9	Recalls parameters of Power Meter from indicated Recall Parameters Menu location.
:M_PWR:TYPE:CW		Selects Continuous Wave measurement type.
:M_PWR:TYPE:PEAK		Selects Peak measurement type.
:M_PWR:TYPE:RMS		Selects Average measurement type.
:M_PWR:EXT:STATEx	0 or OFF, 1 or ON	Enables/Disables External Loss/Gain Offset.
:M_PWR:EXT:STATe?		Returns External Loss/Gain Offset status.
:M_PWR:EXT:OFFSet x	-99.9 to 99.9	Selects External Loss/Gain Offset value.
:M_PWR:EXT:OFFSet?		Returns External Loss/Gain Offset value.
:M_PWR?		Requests return of Power Meter reading in mW.
:M_PWR:PEAK?		Requests return of Power Meter Peak reading in mW.
:M_PWR:DBM x	0 or 1	Enables/Disables Power Meter reading in dBm.
:M_PWR:DBM?		Returns state of Power Meter readings in dBm.
:M_PWR:DBM:STATEx	0 or 1	Enables/Disables Power Meter reading in dBm.
:M_PWR:DBM:STATe?		Returns state of Power Meter readings in dBm.
<b>DEVIATION METER COMMANDS</b>		
:M_DEV:RANGe:UPPer x	2, 5, 10, 20, 50 or 100	Sets Range Value of Deviation Meter in kHz.
:M_DEV:RANGe:AUTO		Enables Autorange of Deviation Meter.
:M_DEV:UL:STATEx	0 or OFF, 1 or ON	Toggles Upper Limit of Deviation Meter on or off.

Table 6-5 IFR-1900 Specific Commands (cont)

COMMAND	RANGE/VALUE	DESCRIPTION
:M_DEV:UL:LEVel x	0.00 to 100.00	Sets Upper Limit Level of Deviation Meter in kHz with 0.05 kHz resolution.
:M_DEV:LL:STATe x	0 or OFF, 1 or ON	Toggles Lower Limit of Deviation Meter on or off.
:M_DEV:LL:LEVel x	0.00 to 100.00	Sets Lower Limit Level of Deviation Meter in kHz with 0.05 kHz resolution.
:M_DEV:ALARM x	0 or OFF, 1 or ON	Enables/Disables Over/Under Limit Alarm of Deviation Meter.
:M_DEV:AVERage x	0 or OFF, 1 or ON	Enables/Disables Averaging of Deviation-RMS Meter.
:M_DEV:PH x	0 or OFF, 1 or ON	Enables/Disables Peak Hold of Deviation Meter.
:M_DEV:STORe x	1 to 9	Stores parameters of Deviation Meter at indicated Store Parameters Menu location.
:M_DEV:RCL x	1 to 9	Recalls parameters of Deviation Meter from indicated Recall Parameters Menu location.
:M_DEV:POS?		Returns positive Deviation Meter reading in kHz.
:M_DEV:NEG?		Returns negative Deviation Meter reading in kHz.
:M_DEV:PEAK:POS?		Returns Positive Deviation Peak reading in kHz.
:M_DEV:PEAK:NEG?		Returns Negative Deviation Peak reading in kHz.
:M_DEV:MODE:BOTH		Reads positive and negative deviation.
:M_DEV:MODE:POSitive		Reads positive deviation only.
:M_DEV:MODE:NEGative		Reads negative deviation only.
:M_DEV:MODE:NORMalize		Reads (pos+neg)/2 deviation.

Table 6-5 IFR-1900 Specific Commands (cont)

COMMAND	RANGE/VALUE	DESCRIPTION
<b>MODULATION METER COMMANDS</b>		
:M_MOD:RANGe:UPPer x	40 or 100	Sets Range Value of Modulation Meter in %.
:M_MOD:RANGe:AUTO		Enables Autorange of Modulation Meter.
:M_MOD:UL:STATe x	0 or OFF, 1 or ON	Toggles Upper Limit of Modulation Meter on or off.
:M_MOD:UL:LEVel x	0.0 to 100.0	Sets Upper Limit Level of Modulation Meter in %.
:M_MOD:LL:STATe x	0 or OFF, 1 or ON	Toggles Lower Limit of Modulation Meter on or off.
:M_MOD:LL:LEVel x	0.0 to 100.0	Sets Lower Limit Level of Modulation Meter in %.
:M_MOD:ALARM x	0 or OFF, 1 or ON	Enables/Disables Over/Under Limit Alarm of Modulation Meter.
:M_MOD:PH x	0 or OFF, 1 or ON	Enables/Disables Peak Hold of Modulation Meter.
:M_MOD:STORe x	1 to 9	Stores parameters of Modulation Meter at indicated Store Parameters Menu location.
:M_MOD:RCL x	1 to 9	Recalls parameters of Modulation Meter from indicated Recall Parameters Menu location.
:M_MOD?		Requests return of Modulation Meter reading in %.
:M_MOD:PEAK?		Requests return of Modulation Meter Peak reading in %.
<b>DISTORTION METER COMMANDS</b>		
:M_DISTortion:SElect:LPASs x	100 to 30000	Selects Low-Pass Filter with cutoff frequency of x Hz.
:M_DISTortion:SElect:CWeight		Selects C-Weight Filter.
:M_DISTortion:FILTer x	600 to 1400	Sets Notch Filter Frequency of Distortion Meter in Hz.
:M_DISTortion:UL:STATe x	0 or OFF, 1 or ON	Toggles Upper Limit of Distortion Meter on or off.

Table 6-5 IFR-1900 Specific Commands (cont)



COMMAND	RANGE/VALUE	DESCRIPTION
:M_DISTortion:UL:LEVel x	0.0 to 20.0	Sets Upper Limit Level of Distortion Meter in %.
:M_DISTortion:LL:STATe x	0 or OFF, 1 or ON	Toggles Lower Limit of Distortion Meter on or off.
:M_DISTortion:LL:LEVel x	0.0 to 20.0	Sets Lower Limit Level of Distortion Meter in %.
:M_DISTortion:ALARM x	0 or OFF, 1 or ON	Enables/Disables Over/Under Limit Alarm of Distortion Meter.
:M_DISTortion:AVErage		Enables Distortion averaging.
:M_DISTortion:PH x	0 or OFF, 1 or ON	Enables/Disables Peak Hold of Distortion Meter.
:M_DISTortion:STORE x	1 to 9	Stores parameters of Distortion Meter at indicated Store Parameters Menu location.
:M_DISTortion:RCL x	1 to 9	Recalls parameters of Distortion Meter from indicated Recall Parameters Menu location.
:M_DISTortion:INPut:DEMOD		Selects Demod Audio Input for Distortion Meter.
:M_DISTortion:INPut:FGEN		Selects AF Generator Input for Distortion Meter.
:M_DISTortion:INPut:SINAD		Selects SINAD Input for Distortion Meter.
:M_DISTortion:INPut:BER		Selects BER Input for Distortion Meter.
:M_DISTortion:INPut:XAUDIO		Selects External Audio Input for Distortion Meter.
:M_DISTortion?		Returns Distortion Meter reading in %.
:M_DISTortion:PEAK?		Returns Distortion Meter Peak reading in %.

Table 6-5 IFR-1900 Specific Commands (cont)

COMMAND	RANGE/VALUE	DESCRIPTION
<b>SINAD METER COMMANDS</b>		
:M_SINAD:SElect:LPASs x	100 to 30000	Selects Low-Pass Filter with cutoff frequency of x Hz.
:M_SINAD:SElect:CWeight		Selects C-Weight Filter.
:M_SINAD:FILTer x	770 or 1000	Sets Notch Filter Frequency of SINAD Meter in Hz.
:M_SINAD:UL:STATe x	0 or OFF, 1 or ON	Toggles Upper Limit of SINAD Meter on or off.
:M_SINAD:UL:LEVel x	3.0 to 30.0	Sets Upper Limit Level of SINAD Meter in dB.
:M_SINAD:LL:STATe x	0 or OFF, 1 or ON	Toggles Lower Limit of SINAD Meter on or off.
:M_SINAD:LL:LEVel x	3.0 to 30.0	Sets Lower Limit Level of SINAD Meter in dB.
:M_SINAD:ALARM x	0 or OFF, 1 or ON	Enables/Disables Over/Under Limit Alarm of SINAD Meter.
:M_SINAD:AVErage		Enables SINAD averaging.
:M_SINAD:PH x	0 or OFF, 1 or ON	Enables/Disables Peak Hold of SINAD Meter.
:M_SINAD:STORe x	1 to 9	Stores parameters of SINAD Meter at indicated Store Parameters Menu location.
:M_SINAD:RCL x	1 to 9	Recalls parameters of SINAD Meter from indicated Recall Parameters Menu location.
:M_SINAD:INPut:DEMOD		Selects Demod Audio Input for SINAD Meter.
:M_SINAD:INPut:SINAD		Selects SINAD/BER Input for SINAD Meter.
:M_SINAD:INPut:FGEN		Selects Function Generator Input for SINAD Meter.
:M_SINAD:INPut:XAUDio		Selects External Audio Input for SINAD Meter.
:M_SINAD:RESolution x	.1 or .5	Selects meter resolution.
:M_SINAD:RESolution?		Returns meter resolution.
:M_SINAD?		Returns SINAD Meter reading in dB.
:M_SINAD:PEAK?		Returns SINAD Meter Peak reading in dB.

Table 6-5 IFR-1900 Specific Commands (cont)

COMMAND	RANGE/VALUE	DESCRIPTION
<b>SIGNAL STRENGTH METER COMMANDS</b>		
:M_SIG:PH x	0 or OFF, 1 or ON	Enables/Disables Peak Hold of Signal Strength Meter.
:M_SIG:STORe x	1 to 9	Stores parameters of Signal Strength Meter at indicated Store Parameters Menu location.
:M_SIG:RCL x	1 to 9	Recalls parameters of Signal Strength Meter from indicated Recall Parameters Menu location.
:M_SIG?		Returns Signal Strength Meter reading.
:M_SIG:PEAK?		Returns Signal Strength Meter Peak reading.
<b>BIT ERROR RATE (BER) METER COMMANDS</b>		
:M_BER:TYPE:GENerator		Sets Bit Error Rate Meter Type to Generator.
:M_BER:TYPE:RECeive		Sets Bit Error Rate Meter Type to Receiver.
:M_BER:TYPE:DUPlax		Sets Bit Error Rate Meter Type to Duplex.
:M_BER:TYPE:BASEband		Sets Bit Error Rate Meter Type to Baseband.
:M_BER:SIZE x	100 to 100000	Sets Bit Error Rate Meter Block Size in bits.
:M_BER:SIZE?		Returns Bit Error Rate Meter Block Size setting in bits.
:M_BER:PATtern:RANDom		Sets Bit Error Rate Meter Data Pattern to "Random."
:M_BER:PATtern:FIXED		Sets Bit Error Rate Meter Data Pattern to "Fixed."
:M_BER:PATtern:USER xx	8 Bit Pattern	Sets Bit Error Rate Meter Data Pattern to "User Defined" (8-bit pattern).
:M_BER:RATE x	75, 150, 300, 600, 1200, 2400, 4800 or 16000	Sets Bit Error Rate Meter bit rate in bps.
:M_BER:RATE?		Returns Bit Error Rate Meter rate setting in bps.

Table 6-5 IFR-1900 Specific Commands (cont)

COMMAND	RANGE/VALUE	DESCRIPTION
:M_BER:POLarity:POSitive		Sets Bit Error Rate Meter data polarity to "Pos. EXT AUDIO" setting.
:M_BER:POLarity:NEGative		Sets Bit Error Rate Meter data polarity to "Neg. SINAD/BER" setting.
:M_BER:STORe x	1 to 9	Stores parameters of Bit Error Rate Meter at indicated Store Parameters Menu location.
:M_BER:RCL x	1 to 9	Recalls parameters of Bit Error Rate Meter from indicated Recall Parameters Menu location.
:M_BER?		Returns Bit Errors for 1 pass.
<b>DIGITAL MULTIMETER COMMANDS</b>		
:M_DMM:FUNCTion:VOLTage:DC		Sets Digital Multimeter Function for DC Voltage measurement.
:M_DMM:FUNCTion:VOLTage:AC		Sets Digital Multimeter Function for AC Voltage measurement.
:M_DMM:FUNCTion:CURREnt:DC		Sets Digital Multimeter Function for DC Current measurement.
:M_DMM:FUNCTion:CURREnt:AC		Sets Digital Multimeter Function for AC Current measurement.
:M_DMM:FUNCTion:RESistance		Sets Digital Multimeter Function for Resistance (ohm) measurement.
:M_DMM:FUNCTion?		Returns Digital Multimeter Function setting.
:M_DMM:RANGe:UPPer x	If ACV or DCV function: .2, 2, 20, 200 or 2000. If ACC or DCC function: .02, .2, 2 or 20. If RESistance Function: .2, 2, 20, 200, 2000 or 20000.	Sets Range Value of Digital Multimeter for selected function.
:M_DMM:RANGe:AUTO		Sets Digital Multimeter for selected function to Autorange.

Table 6-5 IFR-1900 Specific Commands (cont)

COMMAND	RANGE/VALUE	DESCRIPTION
:M_DMM:UL:STATe x	0 or OFF, 1 or ON	Toggles Upper Limit of Digital Multimeter on or off.
:M_DMM:UL:LEVel x	If ACV or DCV function: 0.0000 to 1000.0 (V) If ACC or DCC function: 0.0000 to 19.99 (A) If RESistance Function: 0.000 to 19999 (Ohm)	Sets Upper Limit Level of Digital Multimeter.
:M_DMM:LL:STATe x	0 or OFF, 1 or ON	Toggles Lower Limit of Digital Multimeter on or off.
:M_DMM:LL:LEVel x	If ACV or DCV function: 0.0000 to 1000.0 (V) If ACC or DCC function: 0.0000 to 19.99 (A) If RESistance Function: 0.000 to 1999999 (Ohm)	Sets Lower Limit Level of Digital Multimeter.
:M_DMM:ALARM x	0 or OFF, 1 or ON	Enables/Disables Over/ Under Limit Alarm of Digital Multimeter.
:M_DMM:PH x	0 or OFF, 1 or ON	Enables/Disables Peak Hold of Digital Multimeter.
:M_DMM:INPut:IMPedance x	150, 600 or 1E6	Sets input impedance in ohms for Digital Multimeter ACV or DCV measurement functions.
:M_DMM:STORE x	1 to 9	Stores parameters of Digital Multimeter at indicated Store Parameters Menu location.
:M_DMM:RCL x	1 to 9	Recalls parameters of Digital Multimeter from indicated Recall Parameters Menu location.
:M_DMM?		Returns DMM reading depending on current range and function settings.
<b>PHASE METER COMMANDS</b>		
:M_PM:RANGe:UPPer x	2, 5 or 10	Sets Range Value of Phase Meter in radians.
:M_PM:RANGe:AUTO		Enables Autorange of Phase Meter.
:M_PM:UL:STATe x	0 or OFF, 1 or ON	Toggles Upper Limit of Phase Meter on or off.

Table 6-5 IFR-1900 Specific Commands (cont)

COMMAND	RANGE/VALUE	DESCRIPTION
:M_PM:UL:LEVel x	0.00 to 10.00	Sets Upper Limit Level of Phase Meter in radians.
:M_PM:LL:STATe x	0 or OFF, 1 or ON	Toggles Lower Limit of Phase Meter on or off.
:M_PM:LL:LEVel x	0.00 to 10.00	Sets Lower Limit Level of Phase Meter in radians.
:M_PM:ALARM x	0 or OFF, 1 or ON	Enables/Disables Over/Under Limit Alarm of Phase Meter.
:M_PM:PH x	0 or OFF, 1 or ON	Enables/Disables Peak Hold of Phase Meter.
:M_PM:STORe x	1 to 9	Stores parameters of Phase Meter at indicated Store Parameters Menu location.
:M_PM:RCL x	1 to 9	Recalls parameters of Phase Meter from indicated Recall Parameters Menu location.
:M_PM?		Requests return of Phase Meter reading in 0.01 radians.
<b>DEVIATION METER (RMS) COMMANDS</b>		
:M_DRMS:RANGe:UPPer x	2, 5 or 10	Sets Range Value of Deviation (RMS) Meter in kHz.
:M_DRMS:RANGe:AUTO		Enables Autorange of Deviation-RMS Meter.
:M_DRMS:UL:STATe x	0 or OFF, 1 or ON	Toggles Upper Limit of Deviation-RMS Meter on or off.
:M_DRMS:UL:LEVel x	0.00 to 10.00	Sets Upper Limit Level of Deviation-RMS Meter in kHz.
:M_DRMS:LL:STATe x	0 or OFF, 1 or ON	Toggles Lower Limit of Deviation-RMS Meter on or off.
:M_DRMS:LL:LEVel x	0.00 to 10.00	Sets Lower Limit Level of Deviation-RMS Meter in kHz.
:M_DRMS:ALARM x	0 or OFF, 1 or ON	Enables/Disables Over/Under Limit Alarm of Deviation-RMS Meter.
:M_DRMS:AVErAge x	0 or OFF, 1 or ON	Enables/Disables Averaging of Deviation-RMS Meter.
:M_DRMS:PH x	0 or OFF, 1 or ON	Enables/Disables Peak Hold of Deviation-RMS Meter.

Table 6-5 IFR-1900 Specific Commands (cont)

COMMAND	RANGE/VALUE	DESCRIPTION
:M_DRMS:STORe x	1 to 9	Stores parameters of Deviation-RMS Meter at indicated Store Parameters Menu location.
:M_DRMS:RCL x	1 to 9	Recalls parameters of Deviation-RMS Meter from indicated Recall Parameters Menu location.
:M_DRMS?		Requests return of Deviation-RMS Meter reading in kHz.
<b>PHASE (RMS) METER COMMANDS</b>		
:M_PMRMS:RANGe:UPPer x	1, 5 or 10	Sets Range Value of Phase (RMS) Meter in radians.
:M_PMRMS:RANGe:AUTO		Enables Autorange of Phase (RMS) Meter.
:M_PMRMS:UL:STATe x	0 or OFF, 1 or ON	Toggles Upper Limit of Phase (RMS) Meter on or off.
:M_PMRMS:UL:LEVel x	0.00 to 10.00	Sets Upper Limit Level of Phase (RMS) Meter in radians.
:M_PMRMS:LL:STATe x	0 or OFF, 1 or ON	Toggles Lower Limit of Phase (RMS) Meter on or off.
:M_PMRMS:LL:LEVel x	0.00 to 10.00	Sets Lower Limit Level of Phase (RMS) Meter in radians.
:M_PMRMS:ALARM x	0 or OFF, 1 or ON	Enables/Disables Over/Under Limit Alarm of Phase (RMS) Meter.
:M_PMRMS:AVERage x	0 or OFF, 1 or ON	Enables/Disables Averaging of Phase (RMS) Meter.
:M_PMRMS:PH x	0 or OFF, 1 or ON	Enables/Disables Peak Hold of Phase (RMS) Meter.
:M_PMRMS:STORe x	1 to 9	Stores parameters of Phase (RMS) Meter at indicated Store Parameters Menu location.
:M_PMRMS:RCL x	1 to 9	Recalls parameters of Phase (RMS) Meter from indicated Recall Parameters Menu location.
:M_PMRMS?		Requests return of Phase (RMS) Meter reading in radians.

Table 6-5 IFR-1900 Specific Commands (cont)

COMMAND	RANGE/VALUE	DESCRIPTION
<b>AF LEVEL METER (RMS) COMMANDS</b>		
:M_VRMS?		Returns voltage RMS reading.
<b>OSCILLOSCOPE OPERATION SCREEN COMMANDS</b>		
:SCOPE:STATE x	0 or OFF, 1 or ON	Enables/Disables Oscilloscope Operation Screen.
:SCOPE:SCALE x	For Demod Audio Input and FM Modulation: 2, 4, 10 or 20 (kHz) For AC, DC or GND input: 1, 2, 5, 10, 20, 50, 100, 200, 500, 1000, 2000, 5000, 10000, 20000 or 50000 (mV) For Func Gen or Ext Mod Input: 500, 1000 or 2500	Sets Oscilloscope vertical scale.
:SCOPE:SCALE?		Returns Oscilloscope scale setting.
:SCOPE:SWEEP x	1, 2, 5, 10, 20, 50, 100, 200, 500, 1000, 2000, 5000, 10000, 20000, 50000 or 100000	Sets Oscilloscope horizontal sweep rate in $\mu$ s.
:SCOPE:SWEEP?		Returns of Oscilloscope sweep rate setting in $\mu$ s.
:SCOPE:SOURce x	EXT or INTernal	Selects External Scope Input or Internal routing Scope Input.
:SCOPE:INTernal x	IF, DEMOD, POWer, SINAD, FUNCTion or XAUDio	Sets Oscilloscope Input to: Receiver IF Demodulated Audio RF Power Level SINAD/BER Function Generators External Audio
:SCOPE:INPut:FILTer:LPASs:STATE x	0 or OFF, 1 or ON	Enables Oscilloscope Input from Low-Pass Filter.
:SCOPE:INPut:FILT:LPAS:FREQUency x	0.2 to 50	Sets Low-Pass Filter Frequency in kHz.
:SCOPE:INPut:FILTer:HPASs:STATE x	0 or OFF, 1 or ON	Enables Oscilloscope Input from High-Pass Filter.
:SCOPE:INPut:FILT:HPAS:FREQUency x	0.2 to 100	Sets High-Pass Filter Frequency in kHz.
:SCOPE:INPut:FILT:CWEIght:STATE x	0 or OFF, 1 or ON	Enables Oscilloscope Input from C-Weight Filter.

Table 6-5 IFR-1900 Specific Commands (cont)



COMMAND	RANGE/VALUE	DESCRIPTION
:SCOPE:INPut:FILTer:NOTch:STATe x	0 or OFF, 1 or ON	Enables Oscilloscope Input from internal Notch Filter.
:SCOPE:INPut:FILT:NOT:FREQUency x	0.5 to 1.5	Sets Notch Filter width in kHz.
:SCOPE:COUPLing x	AC, DC or GROund	Sets Oscilloscope internal coupling.
:SCOPE:TRIGger:x	ONE, NORM, AUTO or IMMEDIATE	Sets Oscilloscope Trigger Mode.
:SCOPE:ARM		Arms Oscilloscope (functions only in "One-Shot" mode; Ignored, otherwise).
:SCOPE:LEVEl x	0 to 255	Sets Trigger Level.
:SCOPE:VERTical x	0 to 255	Sets Vertical Offset of Oscilloscope Trace.
:SCOPE:HORIZontal x	-12 to 12	Sets Horizontal Offset of Oscilloscope center line in number of grid divisions.
:SCOPE:FULL		Sets Oscilloscope for "full size" display on RF Generator, Receive, Duplex Transmitter and Duplex Receiver Operation Screens.
:SCOPE:QTR		Sets Oscilloscope for "1/4 size" display on RF Generator, Receive, Duplex Transmitter and Duplex Receiver Operation Screens.
:SCOPE:STORe x	1 to 9	Stores parameters of Oscilloscope Operation Screen at indicated Store Parameters Menu location.
:SCOPE:RCL x	1 to 9	Recalls parameters of Oscilloscope Operation Screen from indicated Recall Parameters Menu location.
:SCOPE:LIVE		Activates Live Scope Mode.
:SCOPE:AVErage x	1 to 100	Activates Average Scope Mode with number of average samples specified.
:SCOPE:COMPare x	1 to 9	Activates Compare Scope Mode. Compares against given stored trace number.

Table 6-5 IFR-1900 Specific Commands (cont)

COMMAND	RANGE/VALUE	DESCRIPTION
:SCOPE:MARKer1:STATe x	0 or OFF, 1 or ON	Enables/Disables Oscilloscope Marker 1.
:SCOPE:MARKer1:STATe?		Returns state of Oscilloscope Marker 1.
:SCOPE:MARKer1:POINT x	0 to 100	Sets Oscilloscope Marker 1 graticule position in 0.25 graticule resolution (100 graticules in grid or 10 per grid division).
:SCOPE:MARKer1:POINT?		Returns Oscilloscope Marker 1 horizontal position in graticules.
:SCOPE:MARKer1:TIME?		Returns Oscilloscope Marker 1 horizontal position in ms.
:SCOPE:MARKer1:AMPLitude?		Returns vertical value of trace at Marker 1 in V. Valid for Live Mode and AC, DC and GND Input.
:SCOPE:MARKer2:STATe x	0 or OFF, 1 or ON	Enables/Disables Oscilloscope Marker 2.
:SCOPE:MARKer2:STATe?		Returns state of Oscilloscope Marker 2.
:SCOPE:MARKer2:POINT x	0 to 100	Sets Oscilloscope Marker 2 graticule position in 0.25 graticule resolution (100 graticules in grid or 10 per grid division).
:SCOPE:MARKer2:POINT?		Returns Oscilloscope Marker 2 horizontal position in graticules.
:SCOPE:MARKer2:TIME?		Returns Oscilloscope Marker 2 horizontal position in ms.
:SCOPE:MARKer2:AMPLitude?		Returns vertical value of trace at Marker 2 in V. Valid for Live Mode and AC, DC and GND Input.
:SCOPE:MARKer:STATe x	0 or OFF, 1 or ON	Enables/Disables Oscilloscope Marker 1.
:SCOPE:MARKer:STATe?		Returns state of Oscilloscope Marker 1.

Table 6-5 IFR-1900 Specific Commands (cont)

COMMAND	RANGE/VALUE	DESCRIPTION
:SCOPE:MARKer:POINT x	0 to 100	Sets Oscilloscope Marker 1 graticule position in 0.25 graticule resolution (100 graticules in grid or 10 per grid division).
:SCOPE:MARKer:POINT?		Returns Oscilloscope Marker 1 horizontal position in graticules.
:SCOPE:MARKer:TIME?		Returns Oscilloscope Marker 1 horizontal position in ms.
:SCOPE:MARKer:AMPLitude?		Returns vertical value of trace at Marker 1 in V.
:SCOPE:MARKer:AOff		Turns off all markers.
:SCOPE:TRACK x	0 or OFF, 1 or ON.	Enables/Disables Oscilloscope tracking.
:SCOPE:DELTA:AMPLitude?		Returns amplitude difference between Marker 1 and Marker 2.
:SCOPE:DELTA:POINT?		Returns horizontal difference between markers in graticules.
:SCOPE:DELTA:TIME?		Returns horizontal difference between markers in ms.
:SCOPE:TRACE:DATA x,y,z	x is storage location number 1 to 9. y is horizontal offset 0 to 399. z is data location where point is placed 0 to 255.	Creates abstract trace, pixel by pixel, at specified memory location.
:SCOPE:TRACE:DATA? x,y,z	x is storage location number 0 to 9. y is horizontal offset 0 to 399 (optional; default = 0). z is number of points to be returned (optional; default = 400).	Returns trace data points from desired stored trace or live trace (0). All data points are returned unless otherwise specified by optional parameters.
:SCOPE:TRACE:MAX? x,y,z	x is storage location number 0 to 9. y is horizontal offset 0 to 399 (optional; default = 0). z is number of points to be returned (optional; default = 400).	Returns x,y position of maximum vertical point in trace. Entire trace is considered unless otherwise specified by optional parameters.

Table 6-5 IFR-1900 Specific Commands (cont)

COMMAND	RANGE/VALUE	DESCRIPTION
:SCOPE:TRACE:MIN? x,y,z	x is storage location number 1 to 9. y is horizontal offset 0 to 399 (optional; default = 0). z is number of points to be returned (optional; default = 400).	Returns x,y position of minimum vertical point in trace. Entire trace is considered unless otherwise specified by optional parameters.
:SCOPE:TRACE:GET? x,y	x is storage location number 1 to 9. y is horizontal offset 0 to 399.	Returns point at location specified. Point returned is vertical pixel value 0 to 255.
<b>SPECTRUM ANALYZER COMMANDS</b>		
:ANLZ:SCAN x	0, 1, 2, 5, 10, 20, 50, 100, 200, 500, 1000, 2000, 5000, 10000, 20000, 50000, 100000, 200000	Sets Spectrum Analyzer Scan Width in kHz.
:ANLZ:SCAN?	0, 1, 2, 5, 10, 20, 50, 100, 200, 500, 1000, 2000, 5000, 10000, 20000, 50000, 100000, 200000	Returns Spectrum Analyzer Scan Width in kHz.
:ANLZ:FREQuency x	250 to 2010000.0	Sets Spectrum Analyzer Frequency in kHz.
:ANLZ:FREQuency?		Returns Spectrum Analyzer Frequency in kHz.
:ANLZ:STATe x	0 or OFF, 1 or ON	Enables/Disables Spectrum Analyzer.
:ANLZ:FULL		Sets Spectrum Analyzer for "full size" display on RF Generator, Receive, Duplex Transmitter and Duplex Receiver Operation Screens.
:ANLZ:QTR		Sets Spectrum Analyzer for "1/4 size" display on RF Generator, Receive, Duplex Transmitter and Duplex Receiver Operation Screens.
:ANLZ:STORE x	1 to 9	Stores parameters of Spectrum Analyzer Operation Screen at indicated Store Parameters Menu location.

Table 6-5 IFR-1900 Specific Commands (cont)

COMMAND	RANGE/VALUE	DESCRIPTION
:ANLZ:RCL x	1 to 9	Recalls parameters of Spectrum Analyzer Operation Screen from indicated Recall Parameters Menu location.
:ANLZ:LIVe		Activates Live Analyzer Mode.
:ANLZ:AVERage x	1 to 100	Activates Average Analyzer Mode. Sample number may be specified. Default is 100.
:ANLZ:PEAK		Activates Peak Hold Analyzer Mode.
:ANLZ:COMPare x	1 to 9	Put Analyzer into Compare Mode. Compares against given stored trace number.
:ANLZ:SCALE x	2 or 10	Sets Analyzer Scale to 2 or 10 dB.
:ANLZ:SCALE?		Returns scale setting.
:ANLZ:SCALE:UNIT:DBM	DBM, DBMV*, DBUV*, DBV*, DBUW*, DBW†. *Functions only when RF Input is ANT. †Forces RF Input to T/R.	Sets reference scale to dBm, dBmV, dBμV, dBV, dBμW, dBW, respectively.
:ANLZ:SCALE:UNIT?		Queries reference setting. Returns dBm and dBW only when RF Input is T/R.
:ANLZ:MARKer1:STATe x	0 or OFF, 1 or ON	Enables/Disables Spectrum Analyzer Marker 1.
:ANLZ:MARKer1:STATe?		Returns state Spectrum Analyzer Marker 1.
:ANLZ:MARKer1:POINT x	0.5 to 100.0	Sets Spectrum Analyzer Marker 1 graticule position in 0.25 graticule resolution (100 graticules in grid or 10 per grid division).
:ANLZ:MARKer1:POINT?		Returns Spectrum Analyzer Marker 1 position in graticules.
:ANLZ:MARKer1:FREQuency?		Returns Spectrum Analyzer Marker 1 position in kHz.

Table 6-5 IFR-1900 Specific Commands (cont)

COMMAND	RANGE/VALUE	DESCRIPTION
:ANLZ:MARKer1:AMPLitude?		Returns Spectrum Analyzer Trace value at point where the Trace crosses Marker 1. This value is in units of Spectrum Analyzer reference setting.
:ANLZ:MARKer2:STATe x	0 or OFF, 1 or ON	Enables/Disables Spectrum Analyzer Marker 2.
:ANLZ:MARKer2:POINT x	0.5 to 100.0	Sets Spectrum Analyzer Marker 2 graticule position in 0.25 graticule resolution (100 graticules in grid or 10 per grid division).
:ANLZ:MARKer2:POINT?		Returns Spectrum Analyzer Marker 2 position in graticules.
:ANLZ:MARKer2:FREQuency?		Request return of Spectrum Analyzer Marker 2 position in kHz.
:ANLZ:MARKer2:AMPLitude?		Returns Spectrum Analyzer Trace value at point where the Trace crosses Marker 2. This value is in units of Spectrum Analyzer reference setting.
:ANLZ:MARKer:STATe x	0 or OFF, 1 or ON	Enables/Disables Spectrum Analyzer Marker 1.
:ANLZ:MARKer:POINT? x	0.5 to 100.0	Sets Spectrum Analyzer Marker 1 graticule position in 0.25 graticule resolution (100 graticules in grid or 10 per grid division).
:ANLZ:MARKer:POINT?		Returns Spectrum Analyzer Marker 1 position in graticules.
:ANLZ:MARKer:FREQuency?		Returns Spectrum Analyzer Marker 1 position in kHz.
:ANLZ:MARKer:AMPLitude?		Returns Spectrum Analyzer Trace value at point where the Trace crosses Marker 1. This value is in units of Spectrum Analyzer reference setting.
:ANLZ:MARKer:AOff		Deactivates all markers.
:ANLZ:MARKer:TRACK x	0 or OFF, 1 or ON	Enables/Disables Marker tracking function.

Table 6-5 IFR-1900 Specific Commands (cont)

COMMAND	RANGE/VALUE	DESCRIPTION
:ANLZ:MARKer:DELTA:AMPLitude?		Returns vertical difference between two markers in current vertical scale units.
:ANLZ:MARKer:DELTA:POINT?		Returns horizontal difference in frequency between two markers in graticules.
:ANLZ:MARKer:DELTA:FREQUency?		Returns horizontal difference in frequency between two markers in MHz.
:ANLZ:TRACE:DATA x,y,z	x is storage location number 1 to 9. y is horizontal offset 0 to 399. z is data location where point is placed 0 to 255.	Creates abstract trace, pixel by pixel, at specified memory location.
:ANLZ:TRACE:DATA? x,y,z	x is storage location number 0 to 9. y is horizontal offset 0 to 399 (optional; default = 0). z is number of points to be returned (optional; default = 400).	Returns trace data points from desired stored trace or live trace (0). All data points are returned unless otherwise specified by optional parameters.
:ANLZ:TRACE:MAX? x,y,z	x is storage location number 0 to 9. y is horizontal offset 0 to 399 (optional; default = 0). z is number of points to be returned (optional; default = 400).	Returns x,y position of maximum vertical point in trace. Entire trace is considered unless otherwise specified by optional parameters.
:ANLZ:TRACE:MIN? x,y,z	x is storage location number 1 to 9. y is horizontal offset 0 to 399 (optional; default = 0). z is number of points to be returned (optional; default = 400).	Returns x,y position of minimum vertical point in trace. Entire trace is considered unless otherwise specified by optional parameters.
:ANLZ:TRACE:GET? x,y	x is storage location number 1 to 9. y is horizontal offset 0 to 399.	Returns point at location specified. Point returned is vertical pixel value 0 to 255.
:ANLZ:TRACK:STATe x	0 or OFF, 1 or ON	Enables/Disables Spectrum Analyzer Tracking Generator.

Table 6-5 IFR-1900 Specific Commands (cont)

COMMAND	RANGE/VALUE	DESCRIPTION
:ANLZ:TRACK:STATe?		Returns status of Tracking Generator.
:ANLZ:TRACK:RESolution:HIGH		Sets Tracking Generator to high resolution trace.
:ANLZ:TRACK:RESolution:MED		Sets Tracking Generator to medium resolution trace.
:ANLZ:TRACK:RESolution:LOW		Sets Tracking Generator to low resolution trace.
:ANLZ:TRACK:RESolution?		Returns Tracking Generator resolution setting.
:ANLZ:TRACK:LEVel x	-137.0 to 0.0	Sets Tracking Generator output level in dBm.
:ANLZ:TRACK:LEVel?		Returns Tracking Generator output level.
:ANLZ:TRACK:BWIDth x	.3, 3, 30, 300 or 3000	Sets Tracking Generator Bandwidth in kHz.
:ANLZ:TRACK:BWIDth?		Returns value of current Tracking Generator bandwidth.
:ANLZ:TRACK:OUTput:TR		Selects T/R Connector for Tracking Generator output.
:ANLZ:TRACK:OUTput:DUPlEx		Selects DUPLEX OUT Connector for Tracking Generator output.
:ANLZ:TRACK:OUTput?		Returns Tracking Generator output selection.
:ANLZ:INPut:ANTenna		Sets Analyzer input to ANT. Analyzer screen should already be displayed.
:ANLZ:INPut:TR		Sets Analyzer input to T/R. Analyzer screen should already be displayed.
:ANLZ:INPut:Attenuation x	LNA, 0, 5, 10, 15, 20, 25, 30	Sets analyzer attenuation value in dB.
:ANLZ:INPut:Attenuation?		Queries analyzer attenuation value.
:ANLZ:INPut?		Queries analyzer input setting.
:ANLZ:TOP?		Queries top of screen scale value.

Table 6-5 IFR-1900 Specific Commands (cont)



COMMAND	RANGE/VALUE	DESCRIPTION
:ANLZ:RLEVel?	0 to 64	Queries scalar offset used in 2 dB/div scale.
:ANLZ:FIND:FREQuency?		Searches for frequency with largest amplitude in Receiver spectrum.
:ANLZ:FIND:REFeRence x		Sets Find frequency amplitude search level in dB.
:ANLZ:FIND:REFeRence?		Queries reference setting.
:ANLZ:MODE:x	DIReCt or CHANnel	Selects Analyzer Mode.
:ANLZ:CHANnel x	1 to 2047	Sets frequency to selected cellular channel.
:ANLZ:CHANnel:FORMat:AMPS:FORward		Selects AMPS (equivalent to NADC-U8) Forward for Analyzer Channel Format.
:ANLZ:CHANnel:FORMat:AMPS:REVerse		Selects AMPS (equivalent to NADC-U8) Reverse for Analyzer Channel Format.
:ANLZ:CHANnel:FORMat:ETACS:FORward		Selects ETACS Forward for Analyzer Channel Format.
:ANLZ:CHANnel:FORMat:ETACS:REVerse		Selects ETACS Reverse for Analyzer Channel Format.
:ANLZ:CHANnel:FORMat:NAMPS:FORward		Selects NAMPS Forward for Analyzer Channel Format.
:ANLZ:CHANnel:FORMat:NAMPS:REVerse		Selects NAMPS Reverse for Analyzer Channel Format.
:ANLZ:CHANnel:FORMat:NAMPS:BAND:x	Lower, Middle or Upper	Selects Band for NAMPS Analyzer Channel Format.
:ANLZ:CHANnel:FORMat:NT400:FORward		Selects NT400 (equivalent to NADC-U4) Forward for Analyzer Channel Format.
:ANLZ:CHANnel:FORMat:NT400:REVerse		Selects NT400 (equivalent to NADC-U4) Reverse for Analyzer Channel Format.
:ANLZ:CHANnel:FORMat:NADC:FORward		Selects NADC Forward for Analyzer Channel Format. Utilizes current setting of NADC band.
:ANLZ:CHANnel:FORMat:NADC:REVerse		Selects NADC Reverse for Analyzer Channel Format. Utilizes current setting of NADC band.

Table 6-5 IFR-1900 Specific Commands (cont)

COMMAND	RANGE/VALUE	DESCRIPTION
:ANLZ:CHANnel:FORMat:NADC:BAND:x	HYper, U4 or U8	Selects NADC band for Analyzer Channel Format.
:ANLZ:CHANnel:FORMat?	Returns one of the following: NADC:FORWARD NADC:REVERSE ETACS:FORWARD ETACS:REVERSE NAMPS:FORWARD NAMPS:REVERSE	Returns Analyzer Channel Format.
:ANLZ:CHANnel:BAND?	Returns one of the following: <u>For NADC format:</u> U8, U4 or HY <u>For ETACS format:</u> NOT AVAILABLE <u>For NAMPS format:</u> LOWER, MIDDLE or UPPER	Returns band for Analyzer Channel Format.
:ANLZ:NORMAlize		Normalizes Analyzer.
<b>RECEIVER COMMANDS</b>		
:RECeive:SQUelch x	0.0 to 1.0	Turn squelch up or down.
:RECeive:SQUelch?		Returns squelch setting.
:RECeive:VOLume x	0.0 to 1.0	Turns volume up or down.
:RECeive:VOLume?		Returns volume setting.
:RECeive:VOLume:AUTO b	0 or OFF, 1 or ON	Enables/Disables Automatic volume control.
:RECeive:VOLume:AUTO?		Returns automatic volume control setting.
:RECeive:FREQUency x	250.0 to 2010000.0	Sets Receiver RF Frequency from 250 kHz to 2010.0000 MHz in 1 kHz steps.
:RECeive:FREQUency?		Returns RF Frequency.
:RECeive:MODulation:x	FM1, FM2, FM3, FM4, AM1, AM2, BFO or PM	Sets Receiver Modulation Type.
:RECeive:MOD:USER:MODulation:x	FM, AM, BFO, PM or DATA	Sets Receiver Modulation Type - User Selected Modulation.
:RECeive:MOD:USER:FILTer x	3, 30 or 300	Sets User selected IF Filter in kHz.

Table 6-5 IFR-1900 Specific Commands (cont)

COMMAND	RANGE/VALUE	DESCRIPTION
:RECeive:MOD:USER:POST:APASs		Sets User selected Post Detection - All Pass.
:RECeive:MOD:USER:POST:HPASs x	0.5 to 20.0	Sets User selected Post Detection High-Pass Filter cutoff in kHz.
:RECeive:MOD:USER:POST:LPASs x	0.1 to 30.0	Sets User selected Post Detection Low-Pass Filter cutoff in kHz.
:RECeive:MOD:USER:POST:BPASs x,y	Range for lower cutoff is 0.5 to 20, for upper cutoff 0.1 to 30.	Sets User selected Post Detection Bandpass Filter cutoff in kHz.
:RECeive:MODulation:USER:POST:CWT		Sets User selected Post Detection C-Weighted Filter.
:RECeive:MODulation?		Returns Modulation Type.
:RECeive:INPut:ANTenna		Selects Antenna Receiver input.
:RECeive:INPut:TR		Selects T/R Connector Receiver input.
:RECeive:INPut:ATTenuation x	LNA, 0, 5, 10, 15, 20, 25, 30	Sets IF Block Attenuator in dB.
:RECeive:OUTput:SPEAKer x	0 or OFF, 1 or ON	Turns Speaker output to on or off.
:RECeive:OUTput:DEMOD x	0 or OFF, 1 or ON	Turns Demod output to on or off.
:RECeive:OUTput:AUDio x	0 or OFF, 1 or ON	Turns Audio output to on or off.
:RECeive:AGC:MANual x	0 to 255	Sets AGC Manual mode level.
:RECeive:AGC:AUTO		Selects AGC Auto mode.
:RECeive:AGC:USER x	MEASure, SPEech, DATA, HIGH, TYPE1, TYPE2 or TYPE3	Selects AGC User Type.
:RECeive:DISToRTion		When followed by SCREEN:RECeiver command, insures Distortion Meter is shown.
:RECeive:SINAD		When followed by SCREEN:RECeiver command, insures SINAD Meter is shown.

Table 6-5 IFR-1900 Specific Commands (cont)

COMMAND	RANGE/VALUE	DESCRIPTION
:RECeive:MODMeter		When followed by SCREEN:RECeiver command, insures Modulation Meter is shown.
:RECeive:DEVRms		When followed by SCREEN:RECeiver command, insures Deviation Meter (RMS) is shown.
:RECeive:PMRms		When followed by SCREEN:RECeiver command, insures Phase (RMS) Meter is shown.
:RECeive:DMM		When followed by SCREEN:RECeiver command, insures DMM is shown.
:RECeive:DECode x	DTMF, TONE or DIGital	Sets Receiver decoding type.
:RECeive:DTMF:STATe x	0 or OFF, 1 or ON	Enables/Disables DTMF decoding.
:RECeive:DTMF?		Returns decoded digits or -1 if nothing decoded.
:RECeive:DIGital x	DCS, DCSINV, DST, POCSAG or DSAT	Sets digital type.
:RECeive:POCSAG:STATe x	0 or OFF, 1 or ON	Enables/Disables POCSAG decoding.
:RECeive:POCSAG:RATE x	0 = LOW, 1 = HIGH	Sets POCSAG rate to decode.
:RECeive:POCSAG:RATE?		Returns POCSAG Rate. 1 for high, 0 for low.
:RECeive:POCSAG:CAPcode?		Returns received capcode or -1 if not available.
:RECeive:POCSAG:TYPE?		Returns POCSAG Function Type or -1 if not available.
:RECeive:POCSAG:MESSAge?		Returns POCSAG message string or -1 if not available.
:RECeive:DCS:STATe x	0 or OFF, 1 or ON	Enables/Disables DCS decoding.
:RECeive:DCS:NORMAL?		Returns received DCS digits or -1 if normal DCS not received.
:RECeive:DCS:INVert?		Returns received DCS digits or -1 if inverted DCS not received.

Table 6-5 IFR-1900 Specific Commands (cont)

COMMAND	RANGE/VALUE	DESCRIPTION
:RECeive:DSAT:STATe x	0 or OFF, 1 or ON	Enables/Disables DSAT decoding.
:RECeive:DSAT?		Returns DSAT reading (NAMPS option installed).
:RECeive:DST:STATe x	0 or OFF, 1 or ON	Enables/Disables DST decoding.
:RECeive:DST?		Returns DST reading (NAMPS option installed).
:RECeive:TONE:STATe x	0 or OFF, 1 or ON	Enables/Disables Audio Tone decoding.
:RECeive:TONE:TYPE x	CCIR, EEA, EIA, ZVEI, DDZVEI, DZVEI, NATEL, EURO, TONE56, CCIRH, CCIRH4 or USER	Sets Audio Tone Type decoded.
:RECeive:TONE?		Returns received Audio Tone sequence or -1 if not available.
:RECeive:FIND:FREQuency?		Returns first frequency with amplitude greater than Find Reference.
:RECeive:FIND:REFerence x	-60 to 30	Sets Find Reference Level in dB.
:RECeive:FIND:REFerence?		Returns Find Reference Level in dB.
:RECeive:SCAN:STARt x	250.0 to 2010000.0	Sets Receiver Scan starting frequency in kHz.
:RECeive:SCAN:STOP x	250.0 to 2010000.0	Sets Receiver Scan stopping frequency in kHz.
:RECeive:SCAN:INCRe ment x	0.0 to 99999.9	Sets Receiver Scan increment in kHz.
:RECeive:SCAN:RATE x	0.00 to 99.99	Sets time, in sec, receiver remains at current frequency if received signal is squelched.
:RECeive:SCAN:PAUSE x	0.0 to 99.9	Sets time, in sec, frequency is received if squelch is broken.
:RECeive:SCAN:CONTInue		Starts or continues Receiver Scan.
:RECeive:SCAN:PAUSE?		Returns 1 if paused; 0 otherwise.
:RECeive:SCAN:ABORT		Aborts Receiver Scan.
:RECeive:SCAN:FREQuency?		Returns frequency currently being scanned.

Table 6-5 IFR-1900 Specific Commands (cont)

COMMAND	RANGE/VALUE	DESCRIPTION
:RECeive:SCAN:FREQList:SQUelch x	0 or OFF, 1 or ON	Enables/Disables Receiver Frequency List Pause time.
:RECeive:SCAN:FREQList:SQUelch?		Returns Receiver Frequency List Squelch State. 0=OFF, 1=ON
:RECeive:SCAN:FREQList:RATE x	.02 to 99.99	Sets Receiver Frequency List Scan Rate in sec.
:RECeive:SCAN:FREQList:RATE?		Returns Receiver Frequency List Scan Rate in 0.01 sec.
:RECeive:SCAN:FREQList:PAUSE x	0.0 to 99.9	Sets Delay Time on Detected Frequency in sec.
:RECeive:SCAN:FREQList:PAUSE?		Returns Receiver Frequency List Scan Pause in 0.1 sec.
:RECeive:MODE x	DIRect, CHANnel, SCAN, LIST or FLScan	Selects Receiver Mode.
:RECeive:MODE?		Returns Receiver Mode.
:RECeive:CHANnel x	1 to 2047	Selects Channel to receive.
:RECeive:CHANnel:FORMat:AMPS:FORward		Selects AMPS (equivalent to NADC-U8) Forward for Receiver Channel Format.
:RECeive:CHANnel:FORMat:AMPS:REVerse		Selects AMPS (equivalent to NADC-U8) Reverse for Receiver Channel Format.
:RECeive:CHANnel:FORMat:ETACS:FORward		Selects ETACS Forward for Receiver Channel Format.
:RECeive:CHANnel:FORMat:ETACS:REVerse		Selects ETACS Reverse for Receiver Channel Format.
:RECeive:CHANnel:FORMat:NAMPS:FORward		Selects NAMPS Forward for Receiver Channel Format.
:RECeive:CHANnel:FORMat:NAMPS:REVerse		Selects NAMPS Reverse for Receiver Channel Format.
:RECeive:CHANnel:FORMat:NAMPS:BAND:x	Lower, Middle or Upper	Selects Band for NAMPS Receiver Channel Format.
:RECeive:CHANnel:FORMat:NT400:FORward		Selects NT400 (equivalent to NADC-U4) Forward for Receiver Channel Format.
:RECeive:CHANnel:FORMat:NT400:REVerse		Selects NT400 (equivalent to NADC-U4) Reverse for Receiver Channel Format.

Table 6-5 IFR-1900 Specific Commands (cont)

COMMAND	RANGE/VALUE	DESCRIPTION
:RECeive:CHANnel:FORMat:NADC:FORward		Selects NADC Forward for Receiver Channel Format. Utilizes current setting of NADC band.
:RECeive:CHANnel:FORMat:NADC:REVerse		Selects NADC Reverse for Receiver Channel Format. Utilizes current setting of NADC band.
:RECeive:CHANnel:FORMat:NADC:BAND:x	HYper, U4 or U8	Selects NADC band for Receiver Channel Format.
:RECeive:CHANnel:FORMAT?	Returns one of the following: NADC:FORWARD NADC:REVERSE ETACS:FORWARD ETACS:REVERSE NAMPS:FORWARD NAMPS:REVERSE	Returns Channel Format.
:RECeive:CHANnel:BAND?	Returns one of the following: <u>For NADC format:</u> U8, U4 or HY <u>For ETACS format:</u> NOT AVAILABLE <u>For NAMPS format:</u> LOWER, MIDDLE or UPPER	Returns band for Receiver Channel Format.
:RECeive:STORe x	1 to 9	Stores parameters.
:RECeive:RCL x	1 to 9	Recalls parameters.
<b>RF GENERATOR COMMANDS</b>		
:GENerator:FREQuency x	250.0 to 2010000.0	Sets Generator RF Frequency 250 kHz to 2010.0000 MHz in 1 kHz steps.
:GENerator:FREQuency?	250.0 to 2010000.0	Requests RF Frequency.
:GENerator:LEVel:UNIT x	DBM, V, MV or UV	Sets RF Generator level units.
:GENerator:LEVel:UNIT?		Returns RF Generator level units.
:GENerator:LEVel:DBM x	-137.0 to 0.0	Sets Output level in dBm.
:GENerator:LEVel:DBM?		Returns output level in dBm.
:GENerator:LEVel x	-137.0 to 0.0 (dBm scale) or 0.000000031 to 0.224 (volts scale)	Sets Output level in current units.

Table 6-5 IFR-1900 Specific Commands (cont)

COMMAND	RANGE/VALUE	DESCRIPTION
:GENerator:STORe x	1 to 9	Stores parameters.
:GENerator:RCL x	1 to 9	Recalls parameters.
:GENerator:DISToRTion		When followed by SCREEN:GENerator command, insures Distortion Meter is shown.
:GENerator:SINAD		When followed by SCREEN:GENerator command, insures SINAD Meter is shown.
:GENerator:AF		When followed by SCREEN:GENerator command, insures AF Meter is shown.
:GENerator:DMM		When followed by SCREEN:GENerator command, insures DMM Meter is shown.
:GENerator:DTMF x,y,z	Range of y and z is 25 to 9999.	x is string to be encoded. y is mark time in ms. z is space time in ms.
:GENerator:POCSAG:BEEP x,y	Range of x is 1 to 4. Range of y is 0 to 9999999.	Generates Beep Tone specified by x for capcode y.
:GENerator:POCSAG:RATE x	0 = LOW, 1 = HIGH	Sets generated POCSAG rate.
:GENerator:POCSAG:RATE?		Returns current POCSAG rate. 1 for high, 0 for low.
:GENerator:POCSAG:NUMeric x	0 to 9999999	Generates a numeric message for capcode x.
:GENerator:POCSAG:ALPHA:LOWer x	0 to 9999999	Generates a lower case message for capcode x.
:GENerator:POCSAG:ALPHA:UPPer x	0 to 9999999	Generates an upper case message for capcode x.
:GENerator:POCSAG:ALPHA:NUMeric x	0 to 9999999	Generates an alphanumeric message for capcode x.
:GENerator:POCSAG:ALPHA:SPECial x	0 to 9999999	Generates a special character message for capcode x.
:GENerator:DCS:NORMal x	000 to 777	Generates DCS octal code in normal mode.
:GENerator:DCS:INVert x	000 to 777	Generates DCS octal code in inverted mode.
:GENerator:DCS:STOP		Stops DCS transmit.

Table 6-5 IFR-1900 Specific Commands (cont)



COMMAND	RANGE/VALUE	DESCRIPTION
:GENerator:DSAT x	0 to 6	Generates DSAT code (NAMPS option installed).
:GENerator:DSAT:STOP		Stops generating continuous DSAT code.
:GENerator:DST x	0 to 6	Generates DST code (NAMPS option installed).
:GENerator:DST:STOP		Stops generating continuous DST code.
:GENerator:IMTS x	0 to 9	Generates IMTS sequence up to 16 characters.
:GENerator:MTS	0 to 9	Generates MTS sequence up to 16 characters.
:GENerator:DIAL x	0 to 9	Generates 2805 pulse sequence up to 16 characters.
:GENerator:DIAL:FREQUENCY x	0.0 to 40000.0	Sets pulse tone frequency to x Hz.
:GENerator:DIAL:FREQUENCY?		Returns current 2805 pulse frequency.
:GENerator:TREMOte x	2050, 1950, 1850, 1750, 1650, 1550, 1450, 1350, 1250, 1150 or 1050	Generates sequence for given frequency in Hz.
:GENerator:TREMOte:STOP		Stops Tone Remote guard tone.
:GENerator:TONE:TYPE x	CCIR, EEA, EIA, ZVEI, DDZVEI, DZVEI, NATEL, EURO, TONE56, CCIRH, CCIRH4, USER	Sets Audio Type to generate.
:GENerator:TONE:USER:DEFine x, y, z	Range of y is 0.0 to 9999.9. Range of z is 20 to 9999.	Defines first character of string x with frequency y in Hz and duration z in ms.
:GENerator:TONE x	0 to 9, A, G, R or -	Generates sequence x using Audio tone previously defined.
:GENerator:OUTput:DEMOD x	0=OFF, 1 or ON	Turns Demod output to on or off.
:GENerator:OUTput:AUDio x	0 or OFF, 1 or ON	Turns Audio output to on or off.
:GENerator:SCAN:STARt x	250.0 to 2010000.0	Sets Generator Scan starting frequency in kHz.
:GENerator:SCAN:STOP	250.0 to 2010000.0	Sets Generator Scan stopping frequency in kHz.
:GENerator:SCAN:INCrement x	0.0 to 99999.9	Sets Generator Scan increment in kHz.

Table 6-5 IFR-1900 Specific Commands (cont)

COMMAND	RANGE/VALUE	DESCRIPTION
:GENerator:SCAN:RATE x	0.00 to 99.99	Sets time, in sec, frequency is transmitted.
:GENerator:SCAN:CONTInue		Starts or continues Generator Scan.
:GENerator:SCAN:ABORT		Aborts Generator Scan.
:GENerator:SCAN:FREQuency?		Returns frequency currently being scanned.
:GENerator:SCAN:FREQList:RATE x	.02 to 99.99	Sets Frequency List Scan Rate in sec.
:GENerator:SCAN:FREQList:RATE?		Returns Generator Frequency List Scan Rate in 0.01 sec.
:GENerator:MODE x	DIRect, CHANnel, SCAN, LIST or FLScan	Selects Generator Mode.
:GENerator:MODE?		Returns Generator Mode.
:GENerator:CHANnel x	1 to 2047	Selects channel.
:GENerator:CHANnel:FORMat:AMPS:FORward		Selects AMPS (equivalent to NADC-U8) Forward as Generator Channel Format.
:GENerator:CHANnel:FORMat:AMPS:REVerse		Selects AMPS (equivalent to NADC-U8) Reverse as Generator Channel Format.
:GENerator:CHANnel:FORMat:ETACS:FORward		Selects ETACS Forward as Generator Channel Format.
:GENerator:CHANnel:FORMat:ETACS:REVerse		Selects ETACS Reverse as Generator Channel Format.
:GENerator:CHANnel:FORMat:NAMPS:FORward		Selects NAMPS Forward for Generator Channel Format.
:GENerator:CHANnel:FORMat:NAMPS:REVerse		Selects NAMPS Reverse for Generator Channel Format.
:GENerator:CHANnel:FORMat:NAMPS:BAND:x	Lower, Middle or Upper	Selects Band for NAMPS Generator Channel Format.
:GENerator:CHANnel:FORMat:NT400:FORward		Selects NT400 (equivalent to NADC-U4) Forward for Generator Channel Format.
:GENerator:CHANnel:FORMat:NT400:REVerse		Selects NT400 (equivalent to NADC-U4) Reverse for Generator Channel Format.
:GENerator:CHANnel:FORMat:NADC:FORward		Selects NADC Forward for Generator Channel Format. Utilizes current setting of NADC band.

Table 6-5 IFR-1900 Specific Commands (cont)

COMMAND	RANGE/VALUE	DESCRIPTION
:GENerator:CHANnel:FORMat:NADC:REVerse		Selects NADC Reverse for Generator Channel Format. Utilizes current setting of NADC band.
:GENerator:CHANnel:FORMat:NADC:BAND:x	HYper, U4 or U8	Selects NADC band for Generator Channel Format.
:GENerator:CHANnel:FORMat?	Returns one of the following: NADC:FORWARD NADC:REVERSE ETACS:FORWARD ETACS:REVERSE NAMPS:FORWARD NAMPS:REVERSE	Returns Channel Format.
:GENerator:SPEAKer:SOURce x	OFF, FGEN, SINAD or EXTMOD	Routes selected connector or source to Test Set Speaker.
:GENerator:CHANnel:BAND?	Returns one of the following: <u>For NADC format:</u> U8, U4 or HY <u>For ETACS format:</u> NOT AVAILABLE <u>For NAMPS format:</u> LOWER, MIDDLE or UPPER	Returns band for Generator Channel Format.
<b>DUPLEX COMMANDS</b>		
:DUPlEx:INPut:FREQuency x	250.0 to 2010000.0	Sets Duplex Transmitter (Receive) Frequency in kHz or specified units.
:DUPlEx:INPut:FREQuency?		Sets Duplex Transmitter Frequency.
:DUPlEx:INPut:MODulation:x	FM1, FM2, FM3, FM4, AM1, AM2, BFO or PM	Sets Duplex Transmitter Modulation Type.
:DUPlEx:INPut:MOD:USER:MODulation:x	FM, AM, BFO, PM or DATA	Sets Duplex Transmitter Modulation Type - User Selected Modulation.
:DUPlEx:INPut:MOD:USER:FILTer x	3, 30 or 300	Sets User selected IF Filter in kHz.
:DUPlEx:INPut:MOD:USER:POST:APASs		Sets User selected Post Detection - All Pass.
:DUPlEx:INPut:MOD:USER:POST:HPAS x	0.5 to 20.0	Sets User selected Post Detection High-Pass Filter cutoff in kHz.

Table 6-5 IFR-1900 Specific Commands (cont)

COMMAND	RANGE/VALUE	DESCRIPTION
:DUPlEx:INPut:MOD:USER:POST:LPASs x	0.1 to 30.0	Sets User selected Post Detection Low-Pass Filter cutoff in kHz.
:DUP:INP:MOD:USER:POST:BPASs x,y	Range for lower cutoff is 0.5 to 20.0. Range for upper cutoff is 0.1 to 30.0.	Sets User selected Post Detection Bandpass Filter with cutoffs in kHz.
:DUPlEx:INPut:MOD:USER:POST:CWT		Sets User selected Post Detection - C-Weighted Filter.
:DUPlEx:INPut:MODulation?		Returns Modulation type.
:DUPlEx:INPut:AGC:MANual x	0 to 255	Sets volume control to manual level specified.
:DUPlEx:INPut:AGC:AUTO		Sets volume control to automatic.
:DUPlEx:INPut:AGC:USER:x	MEASure, SPeech, DATA, HIGH, TYPE1, TYPE2 or TYPE3	Sets volume control to user type specified.
:DUPlEx:INPut:TO:SPEAKer b	0 or OFF, 1 or ON	Enables/Disables routing to speaker.
:DUPlEx:INPut:TO:DEMOD b	0 or OFF, 1 or ON	Enables/Disables routing to DEMOD OUT Connector.
:DUPlEx:INPut:TO:AUDio b	0 or OFF, 1 or ON	Enables/Disables routing to AUDIO OUT Connector.
:DUPlEx:INPut:ANTenna		Selects Antenna Receiver input.
:DUPlEx:INPut:TR		Selects T/R Connector Receiver input.
:DUPlEx:INPut:ATTenuation x	LNA, 0, 5, 10, 15, 20, 25, 30	Sets IF Block Attenuator value in dB.
:DUPlEx:INPut:FIND:FREQuency?		Searches for frequency. with largest amplitude in Receiver spectrum.
:DUPlEx:INPut:FIND:REFerence x		Sets Find frequency amplitude search level in dB.
:DUPlEx:INPut:FIND:REFerence?		Queries reference setting.
:DUPlEx:INPut:METER:MODMeter		When followed by SCREEN:DUPRX command, insures Modulation Meter is shown.

Table 6-5 IFR-1900 Specific Commands (cont)

COMMAND	RANGE/VALUE	DESCRIPTION
:DUPlEx:INPut:METER:DIStortion		When followed by SCREEN:DUPRX command, insures Distortion Meter is shown.
:DUPlEx:INPut:METER:SINAD		When followed by SCREEN:DUPRX command, insures SINAD Meter is shown.
:DUPlEx:INPut:METER:DEVRms		When followed by SCREEN:DUPRX command, insures Deviation Meter (RMS) is shown.
:DUPlEx:INPut:METER:PMRms		When followed by SCREEN:DUPRX command, insures Phase (RMS) Meter is shown.
:DUPlEx:INPut:MODE x	DIReCt, CHANnel, SCAN, LIST, FLScan	Selects Duplex Transmitter Mode.
:DUPlEx:INPut:MODE?		Returns Duplex Transmitter Mode.
:DUPlEx:INPut:CHANnel x	1 to 2047	Selects Duplex Transmitter channel.
:DUPlEx:INPut:CHANnel:FORMat:AMPS:FORward		Selects AMPS (equivalent to NADC-U8) Forward as Duplex Transmitter Channel Format.
:DUPlEx:INPut:CHANnel:FORMat:AMPS:REVerse		Selects AMPS (equivalent to NADC-U8) Reverse as Duplex Transmitter Channel Format.
:DUPlEx:INPut:CHANnel:FORMat:ETACS:FORward		Selects ETACS Forward as Duplex Transmitter Channel Format.
:DUPlEx:INPut:CHANnel:FORMat:ETACS:REVerse		Selects ETACS Reverse as Duplex Transmitter Channel Format.
:DUPlEx:INPut:CHANnel:FORMat:NAMPS:FORward		Selects NAMPS Forward as Duplex Transmitter Channel Format.
:DUPlEx:INPut:CHANnel:FORMat:NAMPS:REVerse		Selects NAMPS Reverse as Duplex Transmitter Channel Format.
:DUPlEx:INPut:CHANnel:FORMat:NAMPS:BAND:x	Lower, Middle or Upper	Selects Band for NAMPS Duplex Transmitter Channel Format.

Table 6-5 IFR-1900 Specific Commands (cont)

COMMAND	RANGE/VALUE	DESCRIPTION
:DUPlEx:INPut:CHANnel:FORMat:NT400:FORward		Selects NT400 (equivalent to NADC-U4) Forward as Duplex Transmitter Channel Format.
:DUPlEx:INPut:CHANnel:FORMat:NT400:REVerse		Selects NT400 (equivalent to NADC-U4) Reverse as Duplex Transmitter Channel Format.
:DUPlEx:INPut:CHANnel:FORMat:NADC:FORward		Selects NADC Forward for Duplex Transmitter Channel Format. Utilizes current setting of NADC band.
:DUPlEx:INPut:CHANnel:FORMat:NADC:REVerse		Selects NADC Reverse for Duplex Transmitter Channel Format. Utilizes current setting of NADC band.
:DUPlEx:INPut:CHANnel:FORMat:NADC:BAND:x	HYper, U4 or U8	Selects NADC band for Duplex Transmitter Channel Format.
:DUPlEx:INPut:CHANnel:FORMat?	Returns one of the following: NADC:FORWARD NADC:REVERSE ETACS:FORWARD ETACS:REVERSE NAMPS:FORWARD NAMPS:REVERSE	Returns Duplex Transmitter Channel Format.
:DUPlEx:INPut:CHANnel:BAND?	Returns one of the following: <u>For NADC format:</u> U8, U4 or HY <u>For ETACS format:</u> NOT AVAILABLE <u>For NAMPS format:</u> LOWER, MIDDLE or UPPER	Returns band for Duplex Transmitter Channel Format.
:DUPlEx:INPut:SCAN:START x	250.0 to 2010000.0	Sets Duplex Transmitter Scan starting frequency in kHz.
:DUPlEx:INPut:SCAN:STOP x	250.0 to 2010000.0	Sets Duplex Transmitter Scan stopping frequency in kHz.
:DUPlEx:INPut:SCAN:INCrement x	0.0 to 99999.9	Sets Duplex Transmitter Scan increment in kHz.
:DUPlEx:INPut:SCAN:RATE x	0.00 to 99.99	Sets time, in sec, receiver remains at current frequency if received signal is squelched.
:DUPlEx:INPut:SCAN:PAUSE x	0.0 to 99.9	Sets time, in sec, frequency is received if squelch is broken.

Table 6-5 IFR-1900 Specific Commands (cont)

COMMAND	RANGE/VALUE	DESCRIPTION
:DUPlEx:INPut:SCAN:CONTInue		Starts or continues Duplex Transmitter Scan.
:DUPlEx:INPut:SCAN:PAUSE?		Returns 1 if paused; 0 otherwise.
:DUPlEx:INPut:SCAN:ABORT		Aborts Duplex Transmitter Scan.
:DUPlEx:INPut:SCAN:FREQUency?		Returns frequency currently being scanned.
:DUPlEx:INPut:SCAN:FREQList: SQUelch x	0 or OFF, 1 or ON	Enables/Disables Duplex Transmitter Frequency List Pause time.
:DUPlEx:INPut:SCAN:FREQList: SQUelch?		Returns 1 if ON, 0 if OFF.
:DUPlEx:INPut:SCAN:FREQList:RATE x	.02 to 99.99	Sets Frequency List Scan Rate in sec.
:DUPlEx:INPut:SCAN:FREQList:RATE?		Returns Duplex Transmitter Frequency List Scan Rate in 0.01 sec.
:DUPlEx:INPut:SCAN:FREQList:PAUSE x.	0.0 to 99.9	Sets Delay Time on Detected Frequency in sec.
:DUPlEx:INPut:SCAN:FREQList:PAUSE?		Returns Duplex Transmitter Frequency List Scan Pause time in .1 sec.
:DUPlEx:GENLock x	0 or OFF, 1 or ON	Slaves DUP-TX to DUP-RX Scan Rate during Frequency List Scan.
:DUPlEx:GENLock?		Returns 1 if locked; 0 otherwise.
:DUPlEx:INPut:VOLume:AUTO x	0 or OFF, 1 or ON	Enables/Disables Automatic Volume Control.
:DUPlEx:INPut:VOLume:AUTO?		Returns Automatic Volume Control status.
:DUPlEx:OUTput:FREQUency x	250.0 to 2010000.0	Sets Duplex Receiver (Generator) Frequency in kHz or specified units.
:DUPlEx:OUTput:FREQUency?		Returns Duplex Generator Frequency.
:DUPlEx:OUTput:OFFSet x	(lower range) -1009.7499 to 1009.7499 (upper range) -1000.0000 to 1000.0000	Sets Duplex Transmitter relative to Duplex Receiver Frequency.
:DUPlEx:OUTput:OFFSet?		Returns Offset in kHz.

Table 6-5 IFR-1900 Specific Commands (cont)

COMMAND	RANGE/VALUE	DESCRIPTION
:DUPlEx:OUTput:LEVel:DBm x	-137.0 to 0.0 (T/R) -120.0 to 10.0 (DPL)	Sets Duplex output level for T/R or Duplex Connectors.
:DUPlEx:OUTput:LEVel:DBm?		Returns Duplex output level.
:DUPlEx:OUTput:DUPlEx		Changes output to Duplex Connector.
:DUPlEx:OUTput:TR		Changes output to T/R Connector.
:DUPlEx:OUTput:DEMOD x	0 or OFF, 1 or ON	Turns Demod output to on or off.
:DUPlEx:OUTput:AUDio x	0 or OFF, 1 or ON	Turns Audio output to on or off.
:DUPlEx:OUTput:METER:DISToRtion		When followed by SCREEN:DUPTX command, insures Distortion Meter is shown.
:DUPlEx:OUTput:METER:SINAD		When followed by SCREEN:DUPTX command, insures SINAD Meter is shown.
:DUPlEx:OUTput:METER:AF		When followed by SCREEN:DUPTX command, insures AF Meter is shown.
:DUPlEx:OUTput:METER:DMM		When followed by SCREEN:DUPTX command, insures DMM Meter is shown.
:DUPlEx:OUTput:MODE x	DIRect, CHANnel, SCAN, LIST, FLScan	Selects Duplex Receiver Mode.
:DUPlEx:OUTput:MODE?		Returns Duplex Receiver Mode.
:DUPlEx:OUTput:CHANnel x	1 to 2047	Selects channel.
:DUPlEx:OUTput:CHANnel:FORMat:AMPS:FORward		Selects AMPS (equivalent to NADC-U8) Forward as Duplex Receiver Channel Format.
:DUPlEx:OUTput:CHANnel:FORMat:AMPS:REVerse		Selects AMPS (equivalent to NADC-U8) Reverse as Duplex Receiver Channel Format.
:DUPlEx:OUTput:CHANnel:FORMat:ETACS:FORward		Selects ETACS Forward as Duplex Receiver Channel Format.
:DUPlEx:OUTput:CHANnel:FORMat:ETACS:REVerse		Selects ETACS Reverse as Duplex Receiver Channel Format.

Table 6-5 IFR-1900 Specific Commands (cont)



COMMAND	RANGE/VALUE	DESCRIPTION
:DUPlEx:OUTput:CHANnel:FORMat: NAMPS:FORward		Selects NAMPS Forward as Duplex Receiver Channel Format.
:DUPlEx:OUTput:CHANnel:FORMat: NAMPS:REVerse		Selects NAMPS Reverse as Duplex Receiver Channel Format.
:DUPlEx:OUTput:CHANnel:FORMat: NAMPS:BAND:x	Lower, Middle or Upper	Selects Band for NAMPS Duplex Receiver Channel Format.
:DUPlEx:OUTput:CHANnel:FORMat: NT400:FORward		Selects NT400 (equivalent to NADC-U4) Forward as Duplex Receiver Channel Format.
:DUPlEx:OUTput:CHANnel:FORMat: NT400:REVerse		Selects NT400 (equivalent to NADC-U4) Reverse as Duplex Receiver Channel Format.
:DUPlEx:OUTput:CHANnel:FORMat: NADC:FORward		Selects NADC Forward for Duplex Receiver Channel Format. Utilizes current setting of NADC band.
:DUPlEx:OUTput:CHANnel:FORMat: NADC:REVerse		Selects NADC Reverse for Duplex Receiver Channel Format. Utilizes current setting of NADC band.
:DUPlEx:OUTput:CHANnel:FORMat: NADC:BAND:x	HYper, U4 or U8	Selects NADC band for Duplex Receiver Channel Format.
:DUPlEx:OUTput:CHANnel:FORMat?	Returns one of the following: NADC:FORWARD NADC:REVERSE ETACS:FORWARD ETACS:REVERSE NAMPS:FORWARD NAMPS:REVERSE	Returns Duplex Receiver Channel Format.
:DUPlEx:OUTput:CHANnel:BAND?	Returns one of the following: <u>For NADC format:</u> U8, U4 or HY <u>For ETACS format:</u> NOT AVAILABLE <u>For NAMPS format:</u> LOWER, MIDDLE or UPPER	Returns band for Duplex Receiver Channel Format.

Table 6-5 IFR-1900 Specific Commands (cont)

COMMAND	RANGE/VALUE	DESCRIPTION
:DUPlEx:OUTput:SCAN:START x	250.0 to 2010000.0	Sets Duplex Receiver Scan starting frequency in kHz.
:DUPlEx:OUTput:SCAN:STOP x	250.0 to 2010000.0	Sets Duplex Receiver Scan stopping frequency in kHz.
:DUPlEx:OUTput:SCAN:INCRe ment x	0.0 to 99999.9	Sets Duplex Receiver Scan increment in kHz.
:DUPlEx:OUTput:SCAN:RATE x	0.00 to 99.99	Sets time, in sec, frequency is transmitted.
:DUPlEx:OUTput:SCAN:RATE?		Returns Duplex Receiver Frequency List Scan Rate in 0.01 sec.
:DUPlEx:OUTput:SCAN:CONTInue		Starts or continues Duplex Receiver Scan.
:DUPlEx:OUTput:SCAN:ABORT		Aborts Duplex Receiver Scan.
:DUPlEx:OUTput:SCAN:FREQUency?		Returns frequency currently being scanned.
:DUPlEx:OUTput:SCAN:FREQList:RATE x	.02 to 99.99	Sets Frequency List Scan Rate in sec.
:DUPlEx:OUTput:SCAN:FREQList:RATE?		Returns Duplex Receiver Frequency List Scan Rate in 0.01 sec.
:DUPlEx:SPEAKer:SOURce x	OFF, FGEN, SINAD or EXTMOD	Selects Speaker source.
:DUPlEx:METER:DISTo rtion		When followed by SCREEN:DUPlEx command, insures Distortion Meter is shown.
:DUPlEx:METER:MODMeter		When followed by SCREEN:DUPlEx command, insures Modulation Meter is shown.
:DUPlEx:METER:SINAD		When followed by SCREEN:DUPlEx command, insures SINAD Meter is shown.
:DUPlEx:METER:OFF		Disables Modulation, Distortion and SINAD Meters.
:DUPlEx:STORE x	1 to 9	Stores parameters.
:DUPlEx:RCL x	1 to 9	Recalls parameters.

Table 6-5 IFR-1900 Specific Commands (cont)

COMMAND	RANGE/VALUE	DESCRIPTION
<b>AF MODULATION COMMANDS</b>		
:FGEN:GEN1:STATe x	0 or OFF, 1 or ON	Turns AF GENERator 1 to on or off.
:FGEN:GEN1:FREQUency x	0.0 to 40000.0	Sets AF GENERator 1 Frequency in Hz.
:FGEN:GEN1:FREQUency?		Returns AF GENERator 1 Frequency in Hz.
:FGEN:GEN1:MODUlation:x	AM, FM, PM or OFF	Sets Modulation type.
:FGEN:GEN1:MODUlation?		Returns Modulation type.
:FGEN:GEN1:MODL x	0 to 90 for AM 0.0 to 100.0 for FM 0.0 to 10.0 for PM	Sets Modulation level. AM in %, FM in kHz, PM in radians.
:FGEN:GEN1:MODL?		Returns Modulation level. AM in %, FM in kHz, PM in radians.
:FGEN:GEN1:SHAPE:x	SIN, SQU, RAMP or TRI	Selects Wave Shape.
:FGEN:GEN1:SHAPE:PULse:DCYCLe 50		Selects Pulse Shape with 50% Duty Cycle.
:FGEN:GEN1:SHAPE:DC x	1, 0 or -1	Sets DC Level to -1, 0 or 1.
:FGEN:GEN1:LEVel x	0 to 100	Sets Generator Proportional output level in %.
:FGEN:GEN1:LEVel?		Returns Generator Proportional output level in %.
:FGEN:GEN2:STATe x	0 or OFF, 1 or ON	Turns AF GENERator 2 to on or off.
:FGEN:GEN2:FREQUency x	0.0 to 40000.0	Sets AF GENERator 2 Frequency in Hz.
:FGEN:GEN2:FREQUency?		Returns AF GENERator 1 Frequency in Hz.
:FGEN:GEN2:MODUlation x	AM, FM, PM or OFF	Sets Modulation type.
:FGEN:GEN2:MODUlation?		Returns Modulation type.
:FGEN:GEN2:MODL x	0 to 90 for AM 0.0 to 100.0 for FM 0.0 to 10.0 for PM	Sets Modulation level. AM in %, FM in kHz, PM in radians.
:FGEN:GEN2:MODL?		Returns Modulation level. AM in %, FM in kHz, PM in radians.
:FGEN:GEN2:SHAPE:x	SIN, SQU, RAMP or TRI	Selects Wave Shape.

Table 6-5 IFR-1900 Specific Commands (cont)

COMMAND	RANGE/VALUE	DESCRIPTION
:FGEN:GEN2:SHAPE:PULse:DCYCLe 50		Selects Pulse Shape with 50% Duty Cycle.
:FGEN:GEN2:SHAPE:DC x	1, 0, -1	Sets DC Level to -1, 0 or 1.
:FGEN:GEN2:LEVel x	0 to 100	Sets Generator Proportional output level in %.
:FGEN:GEN2:LEVel?		Returns Generator Proportional output level in %.
:FGEN:GEN3:MODulation:x	AM, FM, PM or OFF	Sets Modulation type.
:FGEN:GEN3:MODulation?		Returns Modulation type.
:FGEN:GEN3:MODL x	0 to 100 for AM 0 to 100.0 for FM (Tone or RCC) 0 to 10.0 for FM (DTMF) 0 to 25.0 for FM (Digital) 0.0 to 10.0 for PM	Sets Modulation level. AM in %, FM in kHz, PM in radians.
:FGEN:GEN3:MODL?		Returns Modulation level. AM in %, FM in kHz, PM in radians.
:FGEN:GEN3:ENCode x	DTMF, TONE, DIGital, RCC	Sets signaling format for Function Generator 3 to encode. Must be followed with SETUP: or SCREEN: command.
:FGEN:GEN3:DIGital x	DCSINV, POCSAG, DCS, DSAT or DST	Selects digital encoding type.
:FGEN:DATA:STATe x	0 or OFF, 1 or ON	Sets Digital Data Generator to on or off.
:FGEN:DATA:MODulation:x	AM, FM or OFF	Selects Modulation type.
:FGEN:DATA:MODulation?		Returns Modulation type.
:FGEN:DATA:MODL x		Sets Modulation level. AM in %, FM in kHz, PM in radians.
:FGEN:DATA:MODL?		Returns Modulation level. AM in %, FM in kHz, PM in radians.
:FGEN:EXT:STATe x	0 or OFF, 1 or ON	Turns External Mod to on or off.
:FGEN:EXT:MODulation:x	AM, FM, PM or OFF	Sets Modulation type.
:FGEN:EXT:MODulation?		Returns Modulation type.
:FGEN:EXT:MODL x	0 to 90 for AM 0.0 to 100.0 for FM 0.0 to 10.0 for PM	Sets External Modulation level. AM in %, FM in kHz, PM in radians
:FGEN:EXT:MODL?		Returns External Modulation level.

Table 6-5 IFR-1900 Specific Commands (cont)

COMMAND	RANGE/VALUE	DESCRIPTION
:FGEN:EXT:LEVel x	0 to 100	Sets External Modulation Proportional output level in %.
:FGEN:EXT:LEVel?		Returns External Modulation Proportional output level in %.
:FGEN:MIC:STATe x	0 or OFF, 1 or ON	Turns MIC/ACC to on or off.
:FGEN:MIC:MODulation:x	AM, FM, PM or OFF	Sets Modulation type.
:FGEN:MIC:MODulation?		Returns Modulation type.
:FGEN:MIC:MODL x	0 to 90 for AM 0.0 to 100.0 for FM 0.0 to 10.0 for PM	Sets Modulation level. AM in %, FM in kHz, PM in radians.
:FGEN:MIC:MODL?		Returns Modulation level.
:FGEN:MIC:LEVel x	0 to 100	Sets MIC/ACC Connector Proportional output level in %.
:FGEN:MIC:LEVel?		Returns MIC/ACC Connector Proportional output level in %.
:FGEN:OUTput:LEVel x	0 to 3.1000	Sets Audio output level in Volts.
:FGEN:OUTput:LEVel?		Returns Audio output level.
:FGEN:OUTput:SPEAKer x	0 or OFF, 1 or ON	Sets Speaker output to on or off.
:FGEN:OUTput:SPEAKer?		Returns whether Speaker is enabled.
:FGEN:OUTput:DEMod x	0 or OFF, 1 or ON	Sets Demod output to on or off.
:FGEN:OUTput:DEMod?		Returns value of Demod output enable.
:FGEN:OUTput:AUDio x	0 or OFF, 1 or ON	Sets Audio output to on or off.
:FGEN:OUTput:AUDio?		Returns value of Audio output enable.
:FGEN:PROPortional x	0 or OFF, 1 or ON	Sets Proportional output enable.
:FGEN:PROPortional?		Returns value of proportional state.
:FGEN:STORe x	1 to 9	Stores screen parameters.
:FGEN:RCL x	1 to 9	Recalls screen parameters.

Table 6-5 IFR-1900 Specific Commands (cont)

COMMAND	RANGE/VALUE	DESCRIPTION
:FGEN:FSK x	0 or OFF, 1 or ON	Selects GEN1 and GEN2 as two tones for a FSK implementation. GEN1 is designated true tone and GEN2 is designated false tone. Frequency and level of each must be independently set.
:FGEN:BOOST x	0 or OFF, 1 or ON	Enables/Disables Function Generator Boost Mode.
:FGEN:BOOST?		Returns Function Generator Boost Mode status.
<b>SYSTEM COMMANDS</b>		
:SYSTem:FREQList:RECeiver x, y	x = 0 to 99, y = 250.0 to 2010000.0	Defines Receiver Frequency (y) in kHz at Index location (x) in Frequency List.
:SYSTem:FREQList:RECeiver? x	x = 0 to 99	Returns Receiver Frequency value at Specified Index location.
:SYSTem:FREQList:GENerator x, y	x = 0 to 99, y = 250.0 to 2010000.0	Defines Generator Frequency (y) in kHz at Index location (x) in Frequency List.
:SYSTem:FREQList:GENerator? x	x = 0 to 99	Returns Generator Frequency value at specified Index location.
:SYSTem:FREQList:OFFset x, y	x = 0 to 99, y = 250.0 to 2010000.0	Defines OFFset Frequency (y) in kHz at Index location (x) in Frequency List.
:SYSTem:FREQList:OFFset? x	x = 0 to 99	Returns Offset Frequency value at specified Index location.
:SYSTem:FREQList:SCAN x, y	x = 0 to 99, y = 0 (OFF) or 1 (ON)	Disable/Enable scanning at specified index (x) in Frequency List.
:SYSTem:FREQList:SCAN? x	x = 0 to 99	Returns Scan Enable status at specified Index location
<b>GENERIC MEASUREMENT COMMANDS</b>		
:MEASure:VOLTage:DC?		Returns DMM DC voltage reading.
:MEASure:VOLTage:AC?		Returns DMM AC voltage reading.
:MEASure:VOLTage:SUPply? x	-15, 5 or 15	Returns Supply voltage specified.

Table 6-5 IFR-1900 Specific Commands (cont)

COMMAND	RANGE/VALUE	DESCRIPTION
:MEASure:CURRent:DC?		Returns DMM DC current reading.
:MEASure:CURRent:AC?		Return DMM AC current reading.
:MEASure:RESistance?		Returns DMM resistance reading.
:MEASure:POWer?		Returns Power Meter reading.
:MEASure:AUDio?		Returns AF Meter demodulated audio frequency reading.
:MEASure:FREQuency?		Returns RF Meter reading.
:MEASure:PHASe?		Returns Phase Meter reading in radians.
:MEASure:SINAD?		Returns SINAD Meter reading in dB.
:MEASure:TEMPerature:AMBient?		Returns ambient temperature in °C.
:MEASure:TEMPerature:POWer?		Returns Power Term temperature in °C.
:MEASure:SQUelch?		Returns 1 if squelch broken, 0 otherwise.
:MEASure:MIC?		Returns 1 if receiving MIC/ACC Input, 0 otherwise.
<b>MISCELLANEOUS COMMANDS</b>		
:DELAY x		Delays strobe in sec.
:PAD x	0, 20 or 40	Sets Attenuator pads.
:PWR_PAD:STATe x	0 or OFF, 1 or ON	Sets Power Pad on or off.
:PTT:STATe x	0 or OFF, 1 or ON	Sets Push to talk pin on MIC/ACC Connector.
:SCREEN:RECeive		Renews Receiver Screen.
:SCREEN:GENerator		Renews Gen Screen.
:SCREEN:DUPlEx		Renews Duplex Screen.
:SCREEN:DUPRX		Renews Duplex Transmitter Screen.
:SCREEN:DUPTX		Renews Duplex Receiver Screen.
:SCREEN:SCOPE		Renews Scope Screen.

Table 6-5 IFR-1900 Specific Commands (cont)

COMMAND	RANGE/VALUE	DESCRIPTION
:SCREEN:ANLZ		Renews Analyzer Screen.
:SCREEN:FUNC		Renews Function Generator Screen.
:SCREEN:AF		Renews AF Counter Screen.
:SCREEN:FREQuency		Renews Frequency Meter Screen.
:SCREEN:POWer		Renews Power Meter Screen.
:SCREEN:DEV		Renews Deviation Screen.
:SCREEN:MODulation		Renews Mod Meter Screen.
:SCREEN:DISTortion		Renews Distortion Screen.
:SCREEN:SINAD		Renews SINAD Meter Screen.
:SCREEN:SIG		Renews Signal Strength Screen.
:SCREEN:BER		Renews BER Meter Screen.
:SCREEN:DMM		Renews DMM Screen.
:SCREEN:DRMS		Renews Deviation (RMS) Meter Screen.
:SCREEN:PM		Renews Phase Meter Screen.
:SCREEN:PMRMS		Renews Phase (RMS) Meter Screen.
:SCREEN:AFLVL		Renews AF Level Meter Screen.
:SCREEN:USER		Renews Blank Screen for user.
:SETUP:RECeive		Configures hardware for Receiver routing.
:SETUP:GENerator		Configures hardware for Generator routing.
:SETUP:DUPlax		Configures hardware for Duplex routing.
:SETUP:SCOPE		Configures hardware for Scope routing.
:SETUP:ANLZ		Configures hardware for Analyzer screen routing.
:SETUP:FUNC		Configures hardware for AF GENERator screen routing.
:SETUP:DUPTX		Configures hardware for Duplex - TX routing.

Table 6-5 IFR-1900 Specific Commands (cont)



COMMAND	RANGE/VALUE	DESCRIPTION
:SETUP:DUPRX		Configures hardware for Duplex - RX routing.
:SETUP:AF		Configures hardware for AF Meter Screen routing.
:SETUP:DIS TORTion		Configures hardware for Distortion Meter routing.
:SETUP:SINAD		Configures hardware for SINAD Meter routing.
:SETUP:AFLVL		Configures hardware for AF Level Meter Screen routing.
:FLUSH		Flushes query data to remote.

Table 6-5 IFR-1900 Specific Commands (cont)

## 6-7 FLASH MEMORY FILE DIRECTORY OPERATION

The Flash Memory File Directory allows storage of various files including Calibration Data Sets and allows user to select a macro to be executed without remote instruction. Operate Flash Memory File Directory using following procedures:

1. Press MTRS MODE Key. Press "AUX" F6 to display Auxiliary Functions Menu. Press 7 DATA ENTRY Key to display File Directory Screen.

File Directory		Free: 2551040	
Name	Type	Size	Date
SET11	M	23342	06/23/92
SET10	M	23342	06/23/92
STATE1	S	2304	06/23/92
CAL1	B	440	06/23/92
TRACE	T	406	06/23/92
VALUE01	B	13	06/23/92
STRING_12	A	139	06/23/92

Delete   Pack   Init   Exec   Ret

8617099

2. To execute a macro from Flash memory, move cursor to macro. Press "Exec" Soft Function Key F5.
3. To load a Calibration Data Set or a stored Test Set State (Test Set settings at time of store), move cursor to file desired. Press "Load" Soft Function Key F5.
4. To delete a file, move cursor to file. Press "Delete" Soft Function Key F2.  
**NOTE:** To recover Flash Memory space held by deleted files, Pack operation must be performed.
5. To perform Pack operation, press "Pack" Soft Function Key F3. Pack releases memory space taken by deleted files.  
**NOTE:** Files may be lost if power is removed from Test Set during Pack operation.
6. To Initialize Flash Memory, press "Init" Soft Function Key F4. Initializing clears Flash Memory and all files are lost.
7. To return to Auxiliary Functions Menu, press "Ret" Soft Function Key F6.

Files are stored in Flash Memory using remote commands only. Spectrum Analyzer and Oscilloscope Traces and variables are loaded into Test Set using remote commands. Table 6-6 contains remote commands used to operate Flash Memory File Directory.

COMMAND	RANGE/VALUE	DESCRIPTION
:MME:ATT? f	FILE NAME	Returns File (f) Attribute as 0 to 255.
:MME:ATT:DEL f	FILE NAME	Prevents Display from showing Delete for this File.
:MME:ATT:HID f	FILE NAME	Prevents File Name from being displayed on Mass Memory Screen.
:MME:ATT:INIT f	FILE NAME	Prevents Display from showing Init for this File.
:MME:ATT:PACK f	FILE NAME	Prevents Display from showing Pack for this File.
:MME:CATalog?		Returns Flash Memory status. First number returned is memory space used in bytes. Second number returned is memory space available in bytes. Remainder data returned in sets of 3 consisting of file name, file type and file size of each file stored in Flash Memory.
:MME:CATalog:ENTRY? x	0 to 512	Returns line x from Flash Memory File Directory.
:MME:CATalog:FREE?		Returns available file space in bytes.
:MME:CATalog:USED?		Returns used file space in bytes.
:MME:DELEte "f"	f is file name.	Deletes file. Pack operation must be performed to recover memory space.
:MME:INITialize		Erases all files stored in Flash Memory.
:MME:INITialize?		Returns 1 if file system initialized, 0 otherwise.

Table 6-6 Flash Memory Remote Commands

COMMAND	RANGE/VALUE	DESCRIPTION
:MMEMory:LOAD:MACRo "m","f"	m is name of designated macro. f is file name.	Loads macros and variables stored as the file name from Flash Memory into Test Set memory. If m is *, designated macro is executed. If m is macro name, that macro is executed. If m is omitted (""), no macro is executed.
:MMEMory:LOAD:STATe n,"f"	n is number of stored state of Test Set. Set n from 0 to 9. f is file name.	Loads Test Set State stored as f from Flash Memory into Auxiliary Functions "Store Parameters Menu" as entry n.
:MMEMory:LOAD:TRACe:SCOPE n,"f"	n is number of stored trace. Set n from 0 to 9. f is file name.	Loads Oscilloscope trace stored as f into Oscilloscope "Store Parameters Menu" as entry n.
:MMEMory:LOAD:TRACe:ANLZ n,"f"	n is number of stored trace. Set n from 0 to 9. f is file name.	Loads Spectrum Analyzer trace stored as f into Spectrum Analyzer "Store Parameters Menu" as entry n.
:MMEMory:LOAD:DATA "v","f"	v is name of variable. f is file name.	Loads variable stored as f into Test Set memory with name v.
:MMEMory:LOAD:CALibration "f"	f is file name.	Loads Calibration Data from Flash Memory into Test Set memory.
:MMEMory:PACK		Packs Flash Memory and frees memory space from deleted files. Files may be lost if Test Set is powered off during Pack operation.
:MMEMory:STORE:MACRo "m","f"	m is name of designated macro. f is file name.	Stores all Test Set macros and variables (except free variables) into Flash Memory as f with macro specified as designated macro.
:MMEMory:STORE:STATe n,"f"	n is number of stored state of Test Set. Set n from 0 to 9.	Stores entry n of Auxiliary Functions "Store Parameters Menu" as f in Flash Memory.

Table 6-6 Flash Memory Remote Commands (cont)

COMMAND	RANGE/VALUE	DESCRIPTION
:MMEMory:STORe:TRACe:SCOPE n,"f"	n is number of stored trace. Set n from 0 to 9. f is file name.	Stores entry n (stored trace) of Oscilloscope "Store Parameters Menu" as f in Flash Memory.
:MMEMory:STORe:TRACe:ANLZ n,"f"	n is number of stored trace. Set n from 0 to 9. f is file name.	Stores entry n (stored trace) of Spectrum Analyzer "Store Parameters Menu" as f in Flash Memory.
:MMEMory:STORe:DATA "v","f"	v is name of variable. f is file name.	Stores variable v into Flash Memory as f.
:MMEMory:STORe:CALibration "f"	f is file name.	Stores Test Set Calibration Data into Flash Memory.
:MMEMory:TYPE "f"	f is file name.	Returns file type. Returns null string for non-existing files.

Table 6-6 Flash Memory Remote Commands (cont)

Error messages are returned to Host when an error occurs. Error messages are detailed in following table.

ERROR NUMBER	ERROR DEFINITION	DESCRIPTION
220	Parameter Error	Incorrect number of parameters were entered with command.
224	Illegal Parameter Value	A parameter entered was not appropriate for command.
225	Out of Memory	Insufficient memory space to perform command.
250	Flash Storage Error	Indicates Flash Memory could not be erased or data could not be stored in Flash Memory.
253	Corrupt Media	Indicates Flash Memory not properly initialized. Initialize Flash Memory.
254	Media Full	Indicates insufficient Flash Memory space to perform command.
255	Directory Full	Indicates command not performed because 512 file names have been used.
256	File Name Not Found	Specified file not stored in Flash Memory.
257	File Name Error	Indicates command attempted to create file name already stored or file name syntax incorrect.

Table 6-7 Flash Memory Error Messages

# SECTION 7 - CELLULAR AMPS<sup>1</sup>/NAMPS

For AMPS equipment, refer to EIA/TIA-553 Mobile Station-Land Station compatibility Specification.

For NAMPS equipment, refer to IS-88 Mobile Station-Land Compatibility Standard for Dual-Mode Narrowband Analog Cellular Technology.

## 7-1 AMPS/NAMPS CELL SITE MONITOR

The AMPS/NAMPS Cell Site Monitor is used to test NAMPS and AMPS Cell Sites and Mobile Phones. This option is accessed by pressing "Cellr" Soft Function Key F3 from the Receiver Setup Menu. This key only appears if this option is installed. See Figure 7-1 for an illustration of the AMPS/NAMPS Cell Site Monitor screen hierarchy.

### 7-1-1 AMPS/NAMPS CELL SITE MONITOR SETUP

The IFR-1900 is configured for AMPS/NAMPS Cell Site Monitor Operation by using the following procedure:

STEP	PROCEDURE
------	-----------

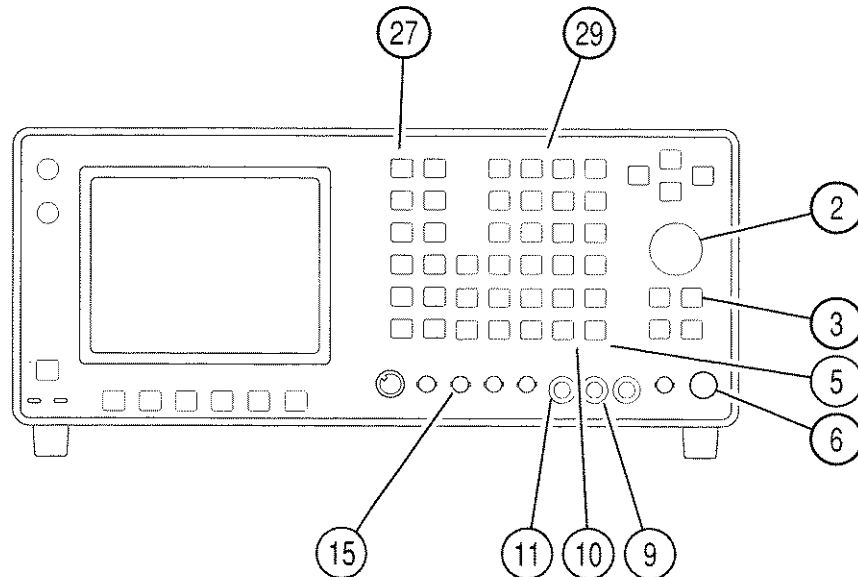

03407023

1. Install Antenna to ANTENNA IN Connector (25) for "off the air" reception. For signals greater than -30 dB (Signal Strength Meter reading greater than 100), route Cellular input through T/R Connector (6).

**CAUTION:** MAXIMUM CONTINUOUS INPUT TO THE ANTENNA IN CONNECTOR (25) IS LIMITED TO 10 W.

MAXIMUM CONTINUOUS INPUT TO THE T/R CONNECTOR (6) IS LIMITED TO 50 W.

1. AMPS protocol is used; however, frequencies are extended to include all of North American Digital Cellular (NADC) frequencies. NADC frequencies consist of the following: 800 MHz (AMPS), 450 MHz (NT400<sup>®</sup>) and 1900 MHz (Hyperband).

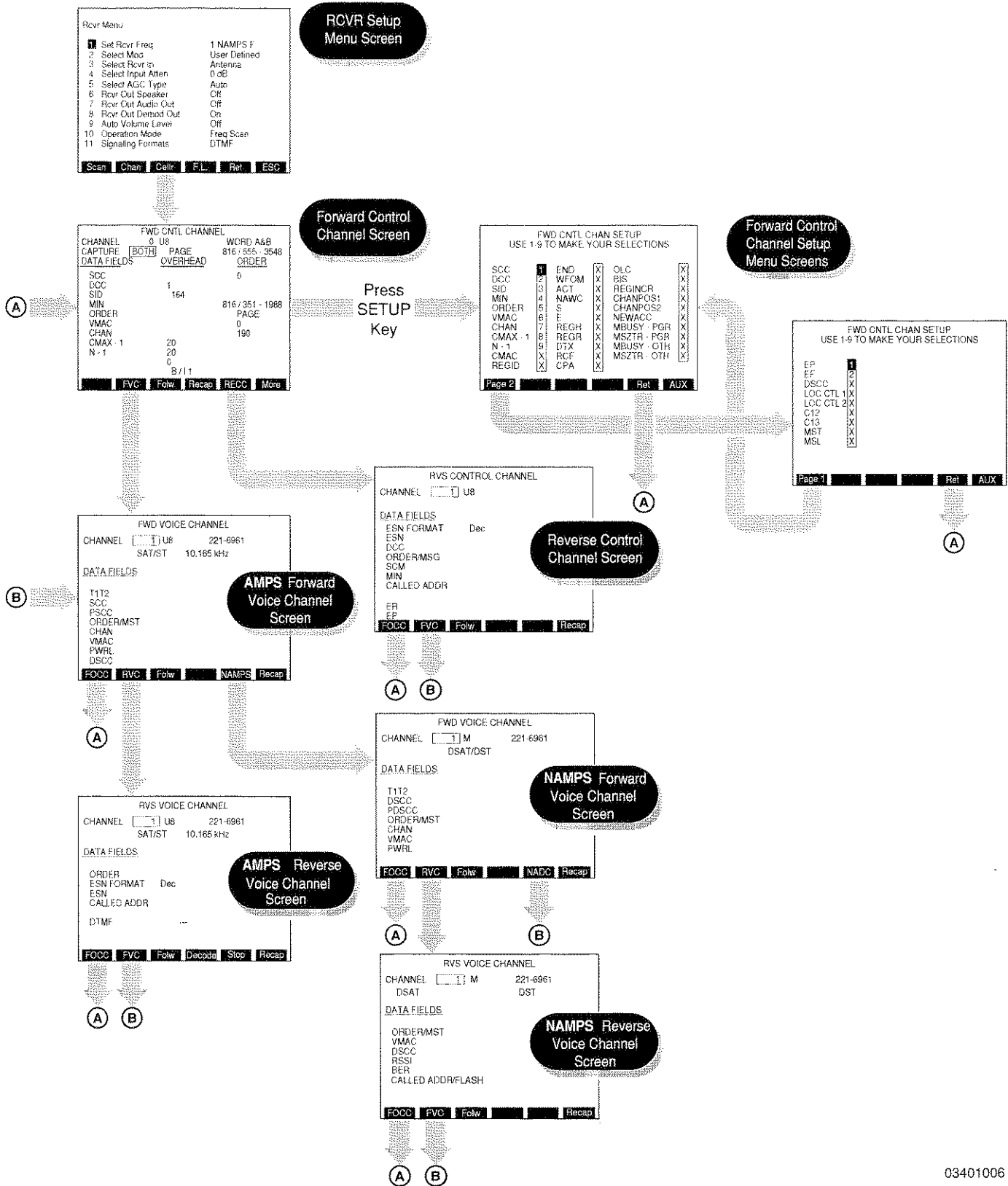
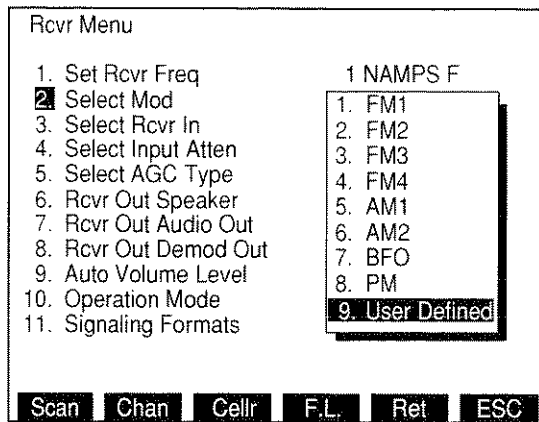

Figure 7-1 AMPS/NAMPS Cell Site Monitor Hierarchy

STEP

PROCEDURE

2. Press RCVR MODE Key (27) and SETUP Key to access Receiver Menu. Press 2 DATA ENTRY Key (29) to access Receiver Select Modulation Menu:



8610235

3. Press 9 DATA ENTRY Key (29) to select "User Defined" and press ENTER Key. User Defined Menu appears:

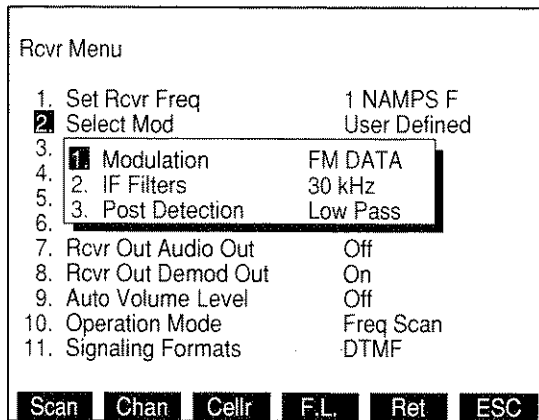

8610236

4. Press 1 DATA ENTRY Key (29) to access User Dined Modulation Menu. Press 5 DATA ENTRY Key (29) to select **FM DATA**.

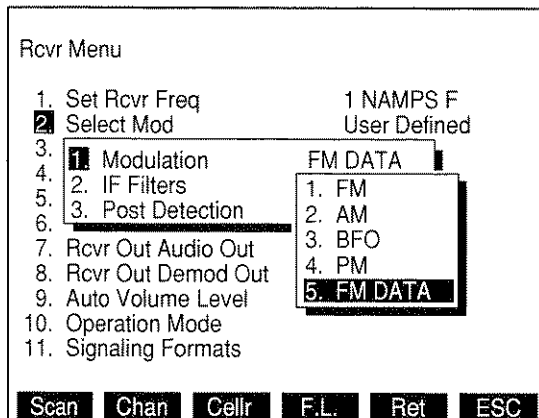

8610237



5. Press 2 DATA ENTRY Key (29) to access User Defined IF Filter Menu. Press 2 DATA ENTRY Key (29) to select **30 kHz**.

Rcvr Menu	
1. Set Rcvr Freq	1 NAMPS F
2. Select Mod	User Defined
3.	
4. 1. Modulation	FM DATA
5. 2. IF Filters	30 kHz
6. 3. Post Detection	1. 3 kHz
	2. 30 kHz
	3. 300 kHz
7. Rcvr Out Audio Out	
8. Rcvr Out Demod Out	
9. Auto Volume Level	On
10. Operation Mode	Freq Scan
11. Signaling Formats	DTMF
Scan Chan Cellr F.L. Ret ESC	

8610238

6. Press 3 DATA ENTRY Key (29) to access User Defined Post Detection Menu. Press 2 DATA ENTRY Key (29) to select **Low Pass**.

Rcvr Menu	
1. Set Rcvr Freq	1 NAMPS F
2. Select Mod	User Defined
3.	
4. 1. Modulation	FM DATA
5. 2. IF Filters	30 kHz
6. 3. Post Detection	Low Pass
	1. All Pass
	2. Low Pass
	3. High Pass
	4. Band Pass
	5. C Wt Pass
7. Rcvr Out Audio Out	
8. Rcvr Out Demod Out	
9. Auto Volume Level	
10. Operation Mode	
11. Signaling Formats	
Scan Chan Cellr F.L. Ret ESC	

8610239

7. Low Pass data field appears. Press 1 and 5 DATA ENTRY Keys (29) to set cutoff frequency to **15.000 kHz** and press ENTER Key. Press "ESC" Soft Function Key F6 to remove User Defined Menu.
8. Press 3 DATA ENTRY Key (29) and ENTER Key to select either "Antenna" (for receiving Cellular input through ANTENNA IN Connector [25]) or "T/R" (for receiving Cellular input through T/R Connector [6]).

9. Press 5 DATA ENTRY Key (29) to access Receiver AGC Menu. Press 1 DATA ENTRY Key (29) to access AGC User Defined Menu. Press 4 DATA ENTRY Key (29) to select **High Speed**.

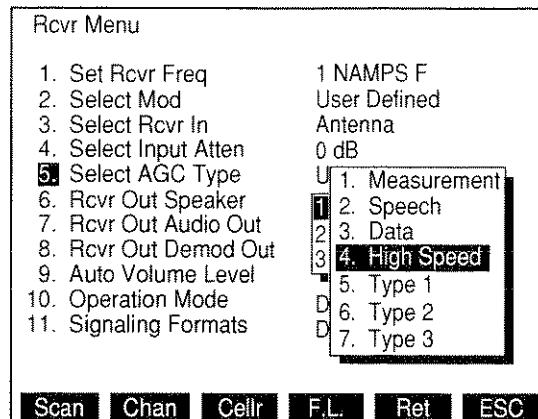

8610241

10. To route demodulated signal to Test Set Speaker, press 6 DATA ENTRY Key (29) until **On** is selected for "6. Rcvr Out Speaker."
11. To route demodulated signal to AUDIO OUT Connector (14), press 7 DATA ENTRY Key (29) until **On** is selected for "7. Rcvr Out Audio Out."
- NOTE:** The Bandwidth for AUDIO OUT Connector (14) is limited by Low-Pass Filter set in step 7.
12. To route demodulated signal to DEMOD OUT Connector (12), press 8 DATA ENTRY Key (29) until **On** is selected for "8. Rcvr Out Demod Out."
- NOTE:** The SAT and Overhead Data is filtered out by C-Weighted Filter installed with DEMOD OUT Connector (12).
13. Current Receiver parameter settings can be stored using Store Parameters Menu (see 4-1-1).
14. Press "Cellr" Soft Function Key F3 to access Forward Control Channel Screen.

## 7-1-2 FORWARD CONTROL CHANNEL SCREEN

The Forward Control Channel Screen is accessed from the Receiver Setup Menu. "Cellr" Soft Function Key F3 appears on the Receiver Menu. Press "Cellr" Soft Function Key F3 to display the Forward Control Channel Screen. The Forward Voice Channel Screen, Reverse Control Channel Screen and Cellular Setup Menu are accessed from the Forward Control Channel Screen.

The Forward Control Channel Screen displays 9 selected Data fields and other data received from the AMPS or NAMPS Cell Site. The Capture and Follow Function are also initiated from this screen. The Capture Function captures data according to the Capture criteria set by the operator and freezes the screen displaying this data. The Follow Function monitors the Voice Channel being used for a call (once the Voice Channel is assigned) displaying the Forward Voice Channel Screen. If a Handoff occurs, the new Voice Channel is monitored. Operation is returned to the Forward Control Channel Screen once the call is completed.

The following description identifies the Forward Control Channel Screen parameters.

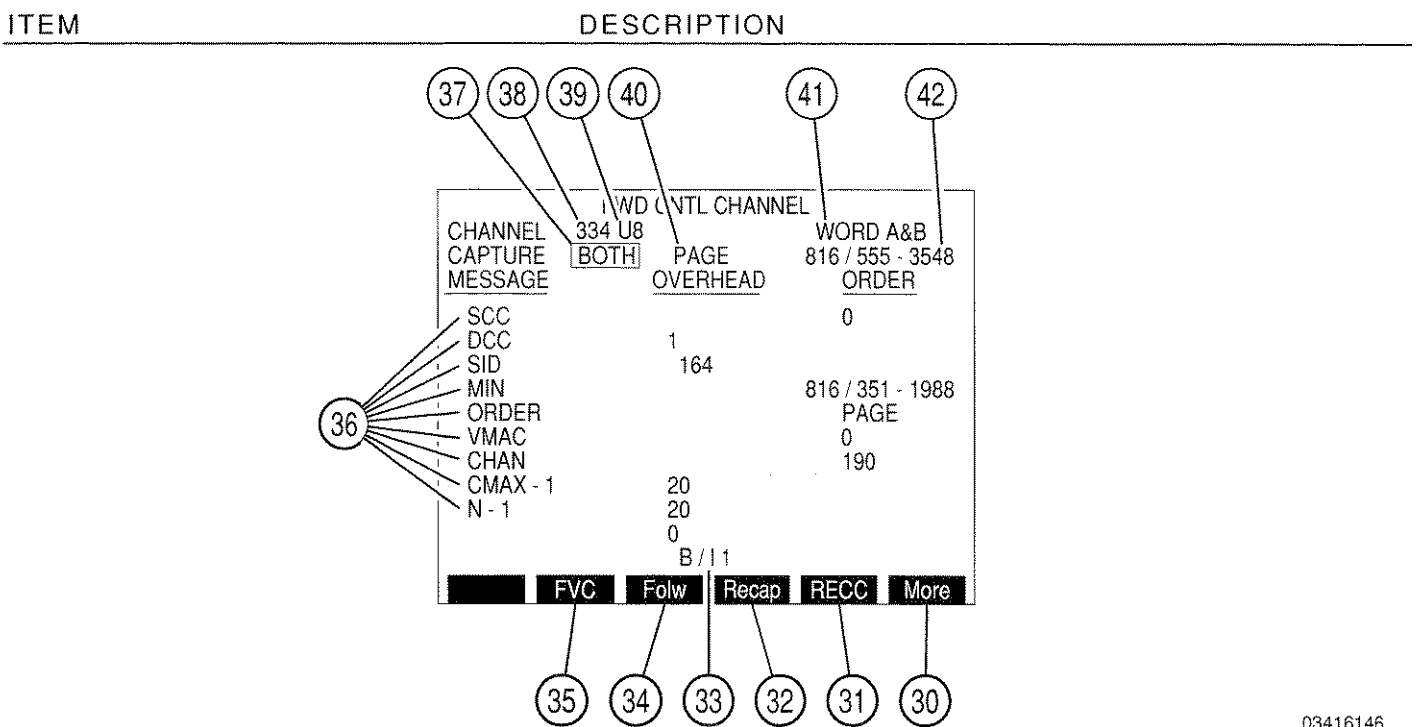

03416146

### 30. "More"/"ESC" Soft Function Key F6

"More" displays additional sets of Soft Function Keys. "ESC" appears during editing of parameters and cancels edit procedure without changing parameter.

### 31. "RECC" Soft Function Key F5

Press "RECC" Soft Function Key F5 to display the Reverse Control Channel Screen.

ITEM	DESCRIPTION
32. <u>"Recap" Soft Function Key F4</u>	Appears when Capture is on. Press "Recap" Soft Function Key F4 to restart the Capture Function.
33. <u>B/I</u>	Displays the Busy/Idle bit status: 0 for Busy, 1 for Idle. Display only.
34. <u>"Folw" Soft Function Key F3</u>	Activates the Follow Function. When a Voice Channel is assigned to a call, the Follow Function enabled displays the Forward Voice Channel Screen and monitors the call. Pressing "RVC" Soft Function Key F2 from the Forward Voice Channel Screen displays the Reverse Voice Channel Screen and continues to monitor the call. If a Handoff occurs, the call is continually monitored on the new channels. Once the call is released, operation is returned to the Forward Control Channel Screen. "Folw" appears in red when enabled.
35. <u>"FVC" Soft Function Key F2</u>	Press "FVC" Soft Function Key F2 to display the Forward Voice Channel Screen.
36. <u>MESSAGE Listing</u>	Displays 9 Forward Control Channel message data fields selected from the Cellular Setup Menu (see 7-1-3).
37. <u>CAPTURE Data Field</u>	<p>Select OFF, ORDER, MIN or BOTH. Capture freezes data displayed on the current screen when a specified order or MIN is received. Selecting BOTH requires the order and MIN to be received before a Capture takes place. Move cursor to Capture data field and press ENTER Key. Use DATA SCROLL ↑ and ↓ Keys (3) to select a Capture Condition and press ENTER Key.</p> <ul style="list-style-type: none"> <li>● If ORDER or BOTH is selected for the Capture data field, move cursor to ORDER (41) and press ENTER Key. Use DATA SCROLL ↑ and ↓ Keys (3) to select an order and press ENTER Key.</li> <li>● If MIN or BOTH is selected for the Capture data field, move cursor to the MIN (43) and press ENTER Key. Use DATA ENTRY Keypad (29) to enter a MIN and press ENTER Key.</li> </ul> <p><b>NOTE:</b> When BOTH is chosen for the Capture Field, and VC DES is the ORDER, a Capture displays the Forward Voice Channel Screen.</p>

## ITEM

## DESCRIPTION

38. CHANNEL

Select Channel on which to transmit. See the following table for range of channels. AMPS Channels 313 to 354 are usually Control Channels. AMPS Channels 313 to 333 are System A channels and channels 334 to 354 are System B channels. Move cursor to CHANNEL and press ENTER Key. Use DATA ENTRY Keypad (29) to enter a channel number and press ENTER Key.

NADC BAND	RANGE OF CHANNELS	FREQUENCY BAND
U8 (AMPS)	1 to 1023	800 MHz
U4 (NT400©)	1 to 333	450 MHz
HY (Hyperband)	1 to 1999	1900 MHz

39. NADC Band

Select NADC band. See the preceding table for NADC bands. Move cursor to band indication and press ENTER Key to activate data field. Press DATA SCROLL ↑ Key (3) to select desired band.

40. ORDER

Selects order to Capture on. Select one of the following:

PAGE	SND ADDR (Send Called-Address)
ALERT	PWR LVL (Change Power Level)
RELEASE	DIR RTRY (Directed Retry)
REORDER	AUT REG (Autonomous Registration)
S ALERT (Stop Alert)	A INTCP (Abbreviated Intercept)
AUDIT	A REORD (Abbreviated Reorder)
MAINTNC (Maintenance)	A ALERT (Abbreviated Alert)
INTRCPT (Intercept)	VC DES (Voice Channel Designation)

41. WORD

Displays current Word choice.

42. MIN

Selects MIN (Mobile Identification Number) to Capture. Use digits 0 to 9, #, \* or Φ (wildcard character). Move cursor to MIN and press ENTER Key. Use DATA SCROLL ↑ Key (3) (in combination with FIELD SELECT ← or → Keys (1) to position small cursor) to enter desired MIN. Press ENTER Key.

Press "More" Soft Function Key F6 for the next set of Soft Function Keys.

ITEM	DESCRIPTION
------	-------------

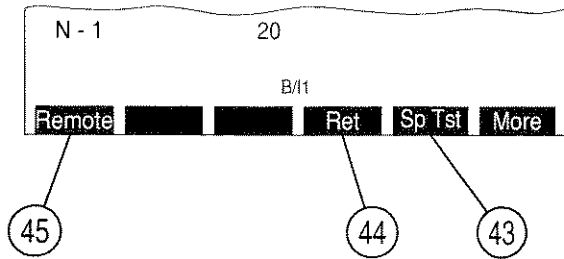

03416147

43. "Sp Tst" Soft Function Key F5

Press "Sp Tst" Soft Function Key F5 to access Dual Mode IS-136 Cellular Option. See IFR-1900 CSA Option Operation Manual.

44. "Ret" Soft Function Key F4

Press "Ret" Soft Function Key F4 to return to the Receiver Operation Screen.

45. "Remote"/"Screen" Soft Function Key F1

"Remote" sends all received data through HOST RS-232 Connector. While Remote is active, the color display is inactive. Data sent through HOST RS-232 Connector uses the following parameters:

Baud rate	38400 b/s
Data bits	8
Stop bits	1
Parity	none
Handshaking	none
Echo	off

"Screen" activates color display and updates the readings of received data displayed (normal operation).

### 7-1-3 FORWARD CONTROL CHANNEL SETUP MENU

When the Forward Control Channel Screen is displayed, press the SETUP Key to access the Forward Control Channel Setup Menu. The Forward Control Channel Setup Menu displays data fields can be selected at one time. The Forward Control Channel Setup Menu is divided into 2 screens, Page 1 and Page 2. Press Soft Function Key F1 to toggle between screens.

To select a data field, move cursor to the right of the data field and press a numeric DATA ENTRY Key (29). The number used determines the order the data field is displayed (1 first to 9 last). To remove a data field from being selected, move cursor to the right of the data field and press any non-numeric DATA ENTRY Key (29). Selecting two data fields with the same digit voids selection of the previous data field. After the desired data fields have been selected, press "Ret" Soft Function Key F5 to return to the Forward Control Channel Screen. Following is the list of data fields and their descriptions:

MENU ITEM	DESCRIPTION
FWD CNTL CHAN SETUP USE 1-9 TO MAKE YOUR SELECTIONS	
SCC	1 END X OLC X
DCC	2 WFOM X BIS X
SID	3 ACT X REGINCR X
MIN	4 NAWC X CHANPOS1 X
ORDER	5 S X CHANPOS2 X
VMAC	6 E X NEWACC X
CHAN	7 REGH X MBUSY - PGR X
CMAX - 1	8 REGR X MSZTR - PGR X
N - 1	9 DTX X MBUSY - OTH X
CMAC	X RCF X MSZTR - OTH X
REGID	X CPA X
Page 2    Ret    AUX	

8610378

- SCC

SCC (Supervisory Audio Tone Color Code) indicates the SAT frequency Mobile Phone is receiving. SCC is displayed in the ORDER Column.

SCC	SAT FREQ (Hz)
00	5970
01	6000
10	6030
11	undefined

- DCC

DCC (Digital Color Code) is displayed in the OVERHEAD Column.

- SID

SID (System Identification Number) is displayed in the OVERHEAD Column.

MENU ITEM	DESCRIPTION
● <u>MIN</u>	MIN (Mobile Identification Number) is displayed in the ORDER Column.
● <u>ORDER</u>	Order Type is displayed in the ORDER Column.
● <u>VMAC</u>	VMAC (Voice Mobile Attenuation Code) sets initial Mobile Phone power level when assigning Mobile Phone to a channel. VMAC is displayed in the ORDER Column.
● <u>CHAN (Voice Channel)</u>	Displays the designated Voice Channel and Band (if NAMPS protocol is used) in the ORDER Column.
● <u>CMAX-1</u>	CMAX is the number of Channels to be scanned by Mobile Phone when accessing a system. CMAX-1 is displayed in the OVERHEAD Column.
● <u>N-1</u>	N is the number of Paging Channels to be scanned by the Mobile Phone. N-1 is displayed in the OVERHEAD Column.
● <u>CMAC</u>	CMAC (Control Mobile Attenuation Code) specifies maximum power level allowed for Mobile Phone transmitting on Reverse Control Channel. CMAC is displayed in the OVERHEAD Column.
● <u>REGID</u>	REGID (Registration Identification) is the last registration number received on Forward Control Channel and is displayed in the OVERHEAD Column.
● <u>END</u>	End Indication bit is set to 1 in the last word of the Overhead Message; 0 otherwise. End Indication bit is displayed in the OVERHEAD Column.
● <u>WFOM</u>	WFOM (Wait For Overhead Message) bit is 1 if Mobile Phone must wait for Overhead Message; 0 otherwise. WFOM is displayed in the OVERHEAD Column.
● <u>ACT</u>	ACT (Global Action) value is displayed in the OVERHEAD Column.



MENU ITEM	DESCRIPTION
-----------	-------------

- NAWC

NAWC (Number of Additional Words Coming) is displayed in the OVERHEAD Column.

- S

S (Serial Number) bit is 1 if Mobile Phone must send its Serial Number to access the system; 0 otherwise. S is displayed in the OVERHEAD Column.

- E

E (Extended Address) bit is 1 if Mobile Phone must send MIN1 and MIN2; 0 if Mobile Phone needs to send MIN1. E is displayed in the OVERHEAD Column.

- REGH

REGH (Registration for Home Mobile Phones) is set to 1 to allow registration of Home Mobile Phones; 0 otherwise. REGH is displayed in the OVERHEAD Column.

- REGR

REGR (Registration for Roaming Mobile Phones) is set to 1 to allow registration of Roaming Mobile Phones; 0 otherwise. REGR is displayed in the OVERHEAD Column.

- DTX

DTX (Discontinuous Transmission) Bits are displayed in the OVERHEAD Column.

DTX BITS	DEFINITION
10	Low level $\geq 8$ dB below high level
11	No minimum for low level
00	DTX not allowed
01	Undefined

- RCF

RCF (Read Control-Filler) bit is 1 if Mobile Phone must read Control-Filler message before accessing system; 0 otherwise. RCF is displayed in the OVERHEAD Column.

- CPA

CPA (Combined Paging/Access) bit is 1 if access functions and paging functions are on the same set of Control Channels. CPA is displayed in the OVERHEAD Column.

- OLC

OLC (Overload Control Class) is displayed in the OVERHEAD Column. Mobile Phones are assigned 1 or more of 16 possible control fields. Each 1 represents an allowed field, each 0 represents a restricted field.

MENU ITEM	DESCRIPTION
● <u>BIS</u>	BIS (Busy-Idle Status) bit is 1 if Mobile Phone must check for idle-to-busy transition on Reverse Control Channel when accessing. BIS is displayed in the OVERHEAD Column.
● <u>REGINCR</u>	REGINCR (Registration Increment) bit identifies increments between Mobile Phone registrations. REGINCR is displayed in the OVERHEAD Column.
● <u>CHANPOS1</u>	CHANPOS1 (Channel Position 1) is the channel position of access channel relative to the first access channel (from Word 3 of the Directed Retry message) and is displayed in the OVERHEAD Column.
● <u>CHANPOS2</u>	CHANPOS2 (Channel Position 2) is the channel position of access channel relative to the first access channel (from Word 4 of the Directed Retry message) and is displayed in the OVERHEAD Column.
● <u>NEWACC</u>	New Access Channel Starting point is displayed in the OVERHEAD Column.
● <u>MBUSY-PGR</u>	MBUSY-PGR (maximum number of busy occurrences allowed for page responses) is displayed in the OVERHEAD Column.
● <u>MSZTR-PGR</u>	MSZTR-PGR (maximum number of seizure attempts allowed for page responses) is displayed in the OVERHEAD Column.
● <u>MBUSY-OTH</u>	MBUSY-OTH (maximum number of busy occurrences allowed for other accesses) is displayed in the OVERHEAD Column.
● <u>MSZTR-OTH</u>	MSZTR-OTH (maximum number of seizure attempts allowed for other accesses) is displayed in the OVERHEAD Column.

Press "Page 2" Soft Function key F1 to access Page 2 of the Forward Control Channel Setup Menu:

MENU ITEM DESCRIPTION

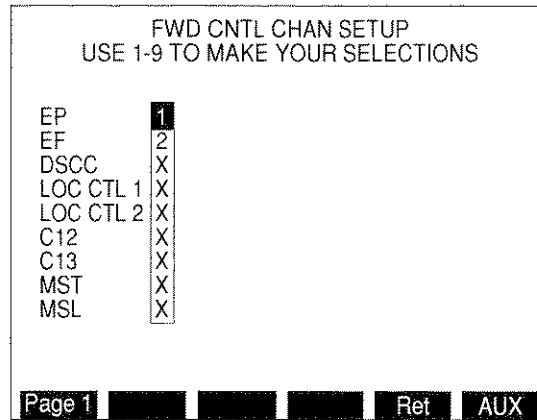

8610202

- EP

Overhead Message extended protocol bit indicating if Mobile Phone is capable of NAMPS protocol; 1 if capable, 0 if not capable.

- EF

Control Message extended protocol bit signifying if NAMPS protocol is used; 1 signifying NAMPS protocol, 0 signifying AMPS protocol.

- DSCC

DSCC (DSAT Color Code) used to verify received DSAT as follows:

DSAT	DSCC
2556CB	000
255B2B	001
256A9B	010
25AD4D	011
26AB2B	100
26B2AD	101
2969AB	110

DSCC also verifies SCC for a handoff to a Wide Analog channel as follows:

SAT	DSCC
00	00
01	01
10	10

## ITEM

## DESCRIPTION

● LOC CTL 1

Displays Local Control message 1 as 4 hexadecimal digits.

● LOC CTL 2

Displays Local Control message 2 as 4 hexadecimal digits.

● C12

Channel number bit 12. C12 and C13 indicate band in the following table:

C12	C13	NAMPS BAND
0	1	Upper
0	0	Middle
1	0	Lower

● C13

Channel number bit 13. See C12.

● MST

Message Types displayed in hexadecimal as follows:

MESSAGE TYPE	HEX BIT PATTERN
NAMPS Channel Assignment	80
Voice Mail	82
CLI (Call Line Identifier) Order	84
Short Message	85
Short Message Full	83
NAMPS Origination or Page Response	00
Not capable of last extended protocol message	07

● MSL

Displays number of messages coming (not counting the first message) as 2 decimal digits.

## 7-1-4 REVERSE CONTROL CHANNEL SCREEN

Press "RECC" Soft Function Key F5 from the Forward Control Channel Screen to display the Reverse Control Channel Screen. Following is a description of the Reverse Control Channel Screen:

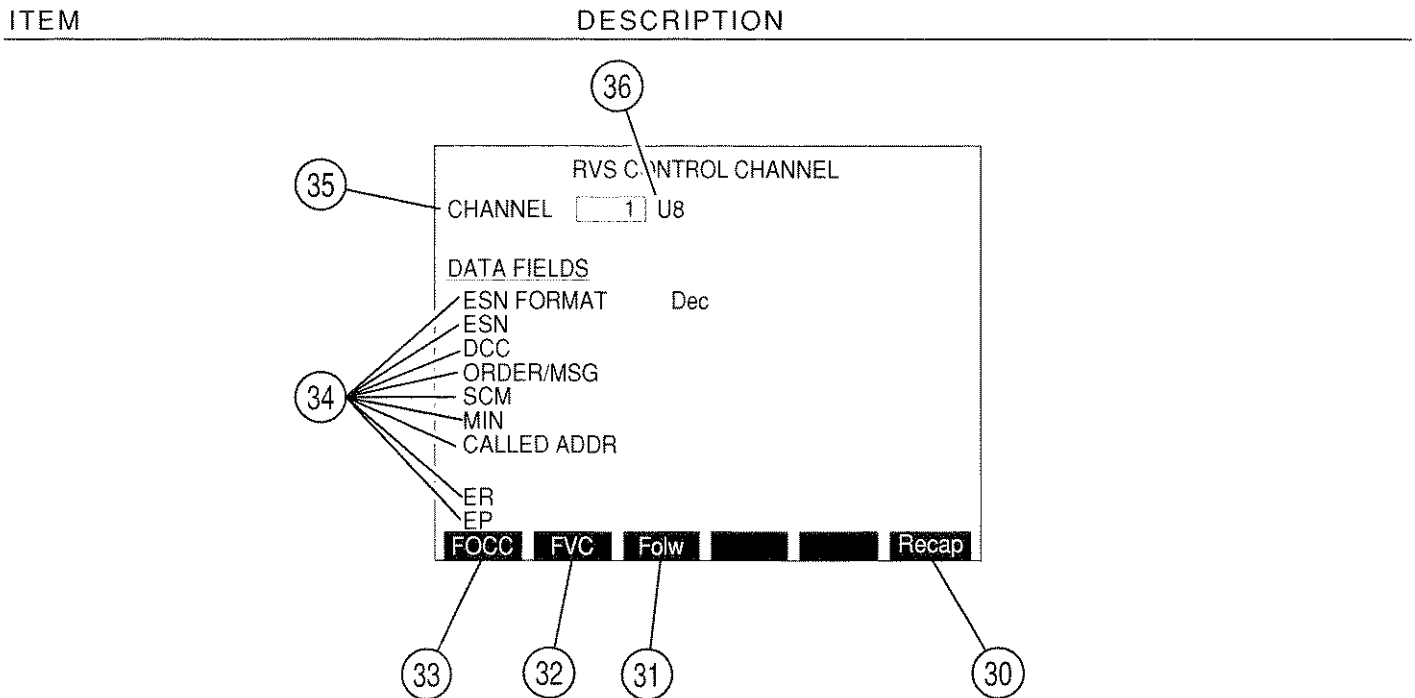

03416148

### 30. "Recap"/"ESC" Soft Function Key F6

"ESC" appears while parameters are accessed for editing. Allows edit procedure to be canceled without changing parameter. Press "Recap" Soft Function Key F6 to restart Capture Function initiated from the Forward Control Channel Screen.

### 31. "Folw" Soft Function Key F3

Press "Folw" Soft Function Key F3 to activate the Follow Function. Follow enabled returns operation to the Forward Control Channel Screen when a call is made. Upon assignment of a Voice Channel, the Forward Voice Channel Screen is displayed monitoring the call. Once the call is released, operation is returned to the Reverse Control Channel Screen. "Folw" appears in red when enabled.

### 32. "FVC" Soft Function Key F2

Press "FVC" Soft Function Key F2 to display the Forward Voice Channel Screen.

### 33. "FOCC" Soft Function Key F1

Press "FOCC" Soft Function Key F1 to display the Forward Control Channel Screen.

## ITEM

## DESCRIPTION

34. Reverse Control Channel Data Fields● ESN FORMAT

Selects numeric base for ESN. Select Dec (decimal), Oct (octal) or Hex (hexadecimal). Move cursor to ESN Format and press ENTER Key. Press DATA SCROLL ↑ Key (3) until desired selection is displayed and press ENTER Key.

● ESN

Displays Electronic Serial Number received from the Mobile Phone.

● DCC

Displays Digital Color Code received from Mobile Phone.

● ORDER/MSG

Displays order type (for AMPS protocol) or message type (for NAMPS protocol) received from Mobile Phone. NAMPS message displayed in hexadecimal as follows:

MESSAGE TYPE	HEX BIT PATTERN
NAMPS Channel Assignment	80
Voice Mail	82
CLI (Call Line Identifier) Order	84
Short Message	85
Short Message Full	83
NAMPS Origination or Page Response	00
Not capable of last extended protocol message	07

● SCM

Displays Station Class Mark received from the Mobile Phone.

● MIN

Displays MIN of the Mobile Phone.

● CALLED ADDR

Displays the Called Address digits received from the Mobile Phone.

● ER

Displays ER bit (1 if NAMPS protocol used, 0 if AMPS protocol used).

● EP

Displays EP bit (1 if NAMPS protocol used, 0 if AMPS protocol used).

**ITEM****DESCRIPTION****35. CHANNEL**

Select Channel on which to transmit. See the following table for range of channels. AMPS Channels 313 to 354 are usually Control Channels. AMPS Channels 313 to 333 are System A channels and channels 334 to 354 are System B channels. Move cursor to CHANNEL and press ENTER Key. Use DATA ENTRY Keypad (29) to enter a channel number and press ENTER Key.

<b>NADC BAND</b>	<b>RANGE OF CHANNELS</b>	<b>FREQUENCY BAND</b>
U8 (AMPS)	1 to 1023	800 MHz
U4 (NT400©)	1 to 333	450 MHz
HY (Hyperband)	1 to 1999	1900 MHz

**36. NADC Band**

Select NADC band. See the following table for NADC bands. Move cursor to band indication and press ENTER Key to activate data field. Press DATA SCROLL ↑ Key (3) to select desired band.

## 7-1-5 FORWARD VOICE CHANNEL SCREEN

### A. AMPS FORWARD VOICE CHANNEL SCREEN

Press "NADC" Soft Function Key F5 to select AMPS protocol for the Forward Voice Channel Screen. ("NAMPS" is displayed on Soft Function Key F5). Following is a description of the Forward Voice Channel Screen using AMPS protocol:

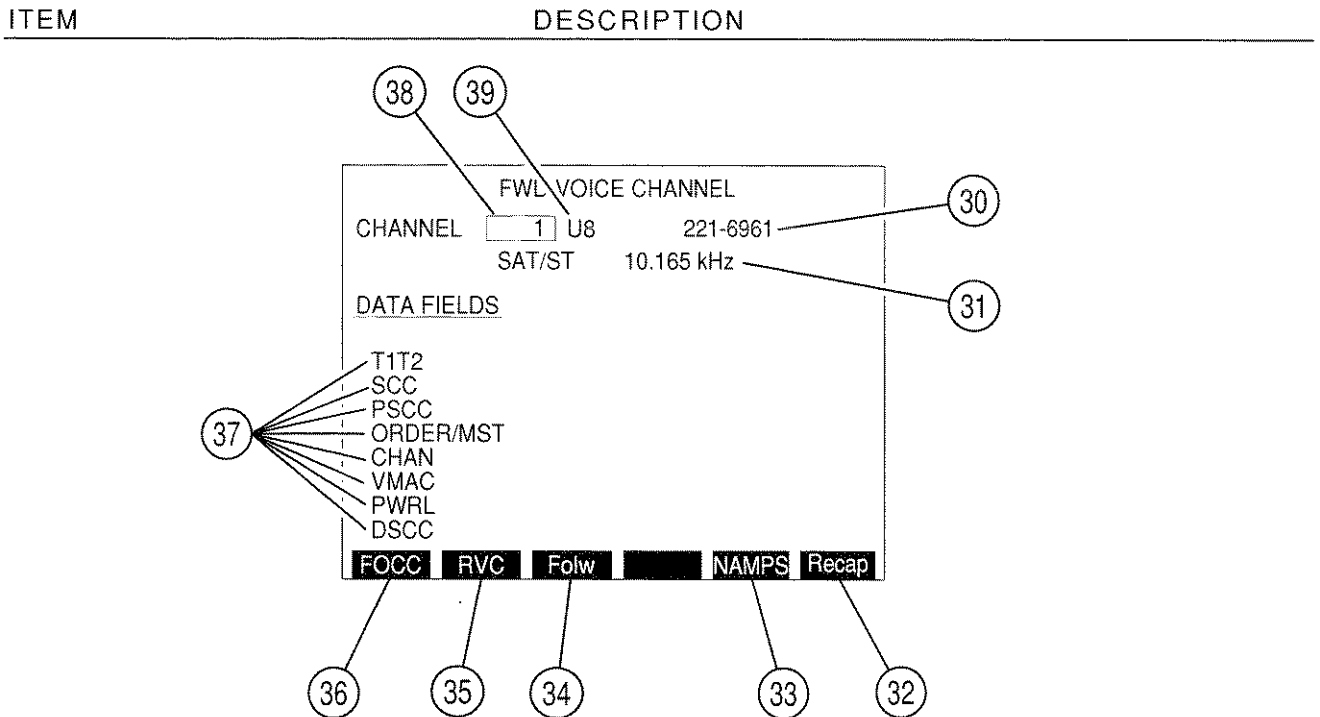

03416149

#### 30. MIN

Displays MIN (Mobile Identification Number) of cellular phone in use on this Forward Voice Channel.

#### 31. SAT/ST

Displays the SAT Frequency received from Cell Site.

#### 32. "Recap"/"ESC" Soft Function Key F6

"ESC" appears while parameters are accessed for editing. Allows edit procedure to be canceled without changing parameter. Press "Recap" Soft Function Key F6 to restart Capture Function initiated from the Forward Control Channel Screen.

#### 33. "NAMPS"/"NADC" Soft Function Key F5

Selects protocol to use in monitoring Forward Voice Channel. Press "NAMPS" Soft Function Key F5 to select NAMPS protocol. Press "NADC" Soft Function Key F5 to select AMPS protocol.



## ITEM

## DESCRIPTION

34. "Folw" Soft Function Key F3

Press "Folw" Soft Function Key F3 to activate the Follow Function. Follow enabled returns operation to the Forward Control Channel Screen when a call is released. "Folw" appears in red when enabled.

35. "RVC" Soft Function Key F2

Press "RVC" Soft Function Key F2 to display the Reverse Voice Channel Screen.

36. "FOCC" Soft Function Key F1

Press "FOCC" Soft Function Key F1 to display the Forward Control Channel Screen.

## 37. Forward Voice Channel Data Fields

● T1T2

T field. Set to identify the message as an order confirmation, as an order or as Called-Address message.

● SCC

SAT Color Code indicates the SAT frequency received from the Cell Site.

SCC	SAT FREQ (Hz)
00	5970
01	6000
10	6030
11	undefined

● PSCC

Displays the Present SAT Color Code of the Forward Voice Channel.

● ORDER/MST

Displays order received from Cell Site.

● CHAN

Displays the new Voice Channel designated for Handoff.

● VMAC

Displays the Voice Mobile Attenuation Code which sets the initial Mobile Phone power level when assigning the Mobile Phone to a Voice Channel.

● PWRL

Displays the Power Level of the Change Power order.

## ITEM

## DESCRIPTION

● DSCC

Displays Digital SAT Color Code received from the Cell Site.

38. CHANNEL

Select Channel on which to transmit. See the following table for range of channels. AMPS Channels 313 to 354 are usually Control Channels. AMPS Channels 313 to 333 are System A channels and channels 334 to 354 are System B channels. Move cursor to CHANNEL and press ENTER Key. Use DATA ENTRY Keypad (29) to enter a channel number and press ENTER Key.

NADC BAND	RANGE OF CHANNELS	FREQUENCY BAND
U8 (AMPS)	1 to 1023	800 MHz
U4 (NT400©)	1 to 333	450 MHz
HY (Hyperband)	1 to 1999	1900 MHz

39. NADC Band

Select NADC band. See the preceding table for NADC bands. Move cursor to band indication and press ENTER Key to activate data field. Press DATA SCROLL ↑ Key (3) to select desired band.

**B. NAMPS FORWARD VOICE CHANNEL SCREEN**

Press "FVC" Soft Function Key F2 from the Forward Control Channel Screen to display the Forward Voice Channel Screen. The Forward Voice Channel Screen appears monitoring a Forward Voice Channel using NAMPS or AMPS protocol. Press "NAMPS" Soft function Key F5 to use NAMPS protocol. ("NADC" is displayed on Soft Function Key F5.) Press "NADC" Soft function Key F5 to use AMPS protocol. Following is a description of the Forward Voice Channel Screen using NAMPS protocol:

ITEM	DESCRIPTION
------	-------------

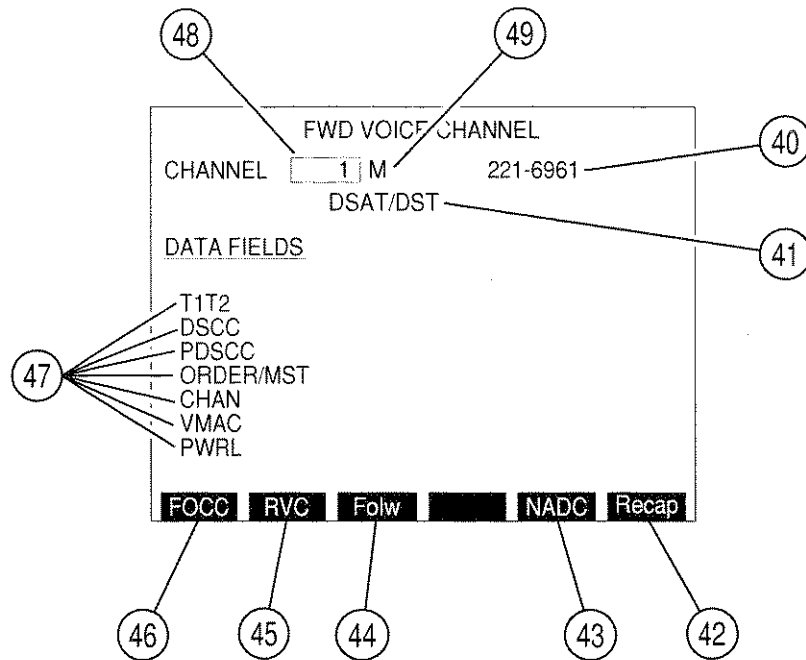

03416150

**40. MIN**

Displays MIN (Mobile Identification Number) of cellular phone in use on this Forward Voice Channel.

**41. DSAT/DST**

Displays Digital SAT received from the Cell Site. DST is logical inverse of DSAT.

**42. "Recap"/"ESC" Soft Function Key F6**

"ESC" appears while parameters are accessed for editing. Allows edit procedure to be canceled without changing parameter. Press "Recap" Soft Function Key F6 to restart Capture Function initiated from the Forward Control Channel Screen.

**43. "NADC"/"NAMPS" Soft Function Key F5**

Selects protocol to use in monitoring forward Voice Channel. Press "NADC" Soft Function Key F5 to select AMPS protocol. Press "NAMPS" Soft Function Key F5 to select NAMPS protocol.

## ITEM

## DESCRIPTION

44. "Folw" Soft Function Key F3

Press "Folw" Soft Function Key F3 to activate the Follow Function. Follow, when enabled, returns operation to the Forward Control Channel Screen when a call is released. "Folw" appears in red when enabled.

45. "RVC" Soft Function Key F2

Press "RVC" Soft Function Key F2 to display the Reverse Voice Channel Screen.

46. "FOCC" Soft Function Key F1

Press "FOCC" Soft Function Key F1 to display the Forward Control Channel Screen.

47. Forward Voice Channel Data Fields● T1T2

T field. Set to identify the message as an order confirmation, as an order or as Called-Address message.

● DSCC

Displays Digital SAT Color Code in decimal.

● PDSCC

Displays Present Digital SAT Color Code in decimal.

● ORDER/MST

Displays Messages received from the Cell Site in hexadecimal as follows:

MESSAGE TYPE	HEX BIT PATTERN
NAMPS Channel Assignment	80
Voice Mail	82
CLI (Call Line Identifier) Order	84
Short Message	85
Short Message Full	83
NAMPS Origination or Page Response	00
Not capable of last extended protocol message	07

● CHAN

Displays the new Voice Channel and band designated for Handoff.

● VMAC

Displays the Voice Mobile Attenuation Code which sets the initial Mobile Phone power level when assigning the Mobile Phone to a Voice Channel.

ITEM

DESCRIPTION

---

● PWRL

Displays the Power Level of the Change Power order.

48. CHANNEL

Selects Forward Voice Channel to monitor. Range is from 1 to 1023. Use DATA ENTRY Keypad (29) or DATA SCROLL to enter a channel and press ENTER Key.

49. U/M/L

Selects Upper (10 kHz above channel frequency), Middle (actual channel frequency) or Lower (10 kHz below channel frequency). Move cursor to U and press ENTER Key. Use DATA SCROLL ↑ Key (3) to set U, M or L and press ENTER Key.

## 7-1-6 REVERSE VOICE CHANNEL SCREEN

### A. AMPS RVS VOICE CHANNEL SCREEN

Pressing "RVC" Soft Function Key F2 from the Forward Voice Channel Screen displays the Reverse Voice Channel Screen. Following is a description of the AMPS Reverse Voice Channel Screen.

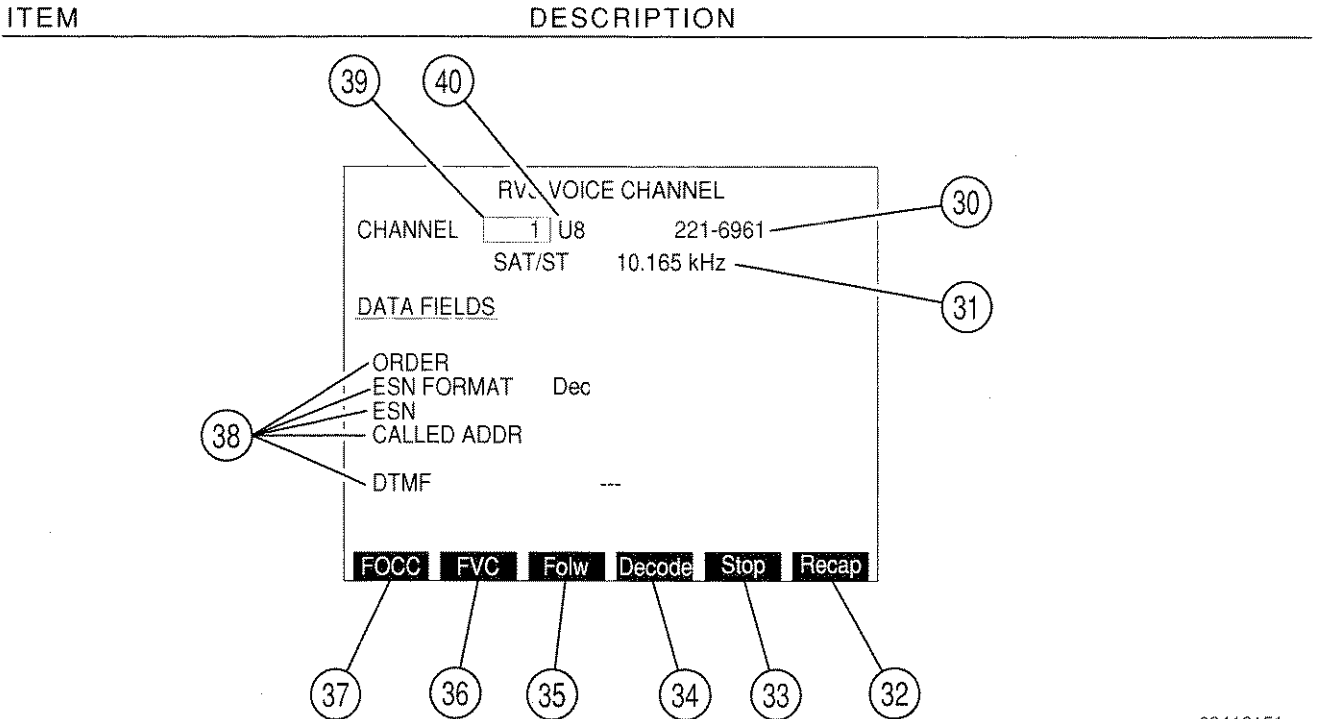

03416151

30. MIN

Displays MIN (Mobile Identification Number) of cellular phone in use on this Reverse Voice Channel.

31. SAT/ST

Displays the frequency of SAT Tone sent by Mobile Phone in Hz.

32. "Recap"/"ESC" Soft Function Key F6

"ESC" appears while parameters are accessed for editing. Allows edit procedure to be canceled without changing parameter. Press "Recap" Soft Function Key F6 to restart Capture Function initiated from the Forward Control Channel Screen.

33. "Stop" Soft Function Key F5

Press "Stop" Soft Function Key F5 to stop DTMF decoding. Appears while decoding.

34. "Decode" Soft Function Key F4

Press "Decode" Soft Function Key F4 to decode DTMF. Appears in red when active. Continues to decode until "Stop" Soft Function Key F5 is pressed. Press "Stop" Soft Function Key F5 again to clear screen.

ITEM	DESCRIPTION
------	-------------

35. "Folw" Soft Function Key F3

Press "Folw" Soft Function Key F3 to activate the Follow Function. When Follow is enabled, operation is returned to the Forward Control Channel Screen when a call being monitored is dropped. "Folw" appears in red when active.

36. "FVC" Soft Function Key F2

Press "FVC" Soft Function Key F2 to display the Forward Voice Channel Screen.

37. "FOCC" Soft Function Key F1

Press "FOCC" Soft Function Key F1 to display the Forward Control Channel Screen.

38. Reverse Voice Channel Data Fields

- ORDER

Displays the order sent from the Mobile Phone.

- ESN FORMAT

Selects format used to display ESN of Mobile Phone. Select Dec (decimal), Hex (hexadecimal) or Oct (octal). Move cursor to ESN FORMAT data field and press ENTER Key. Press DATA SCROLL ↑ Key (3) until desired format appears and press ENTER Key. Selected format appears when next ESN is received.

- ESN

Displays Electronic Serial Number of Mobile Phone in format specified.

- CALLED ADDR

Displays number the Mobile Phone is calling.

- DTMF

Displays DTMF transmissions from Mobile Phone after a call is established. 20 digits are displayed at a time.

39. CHANNEL

Select Channel on which to transmit. See the following table for range of channels. AMPS Channels 313 to 354 are usually Control Channels. AMPS Channels 313 to 333 are System A channels and channels 334 to 354 are System B channels. Move cursor to CHANNEL and press ENTER Key. Use DATA ENTRY Keypad (29) to enter a channel number and press ENTER Key.

NADC BAND	RANGE OF CHANNELS	FREQUENCY BAND
U8 (AMPS)	1 to 1023	800 MHz
U4 (NT400©)	1 to 333	450 MHz
HY (Hyperband)	1 to 1999	1900 MHz

ITEM

DESCRIPTION

---

40. NADC Band

Select NADC band. See the preceding table for NADC bands. Move cursor to band indication and press ENTER Key to activate data field. Press DATA SCROLL ↑ Key (3) to select desired band.



## B. NAMPS RVS VOICE CHANNEL SCREEN

Press "FVC" Soft Function Key F2 to return to the AMPS Forward Voice Channel Screen.  
 Press "NAMPS" Soft Function Key F5 to go the NAMPS Forward Voice Channel Screen:

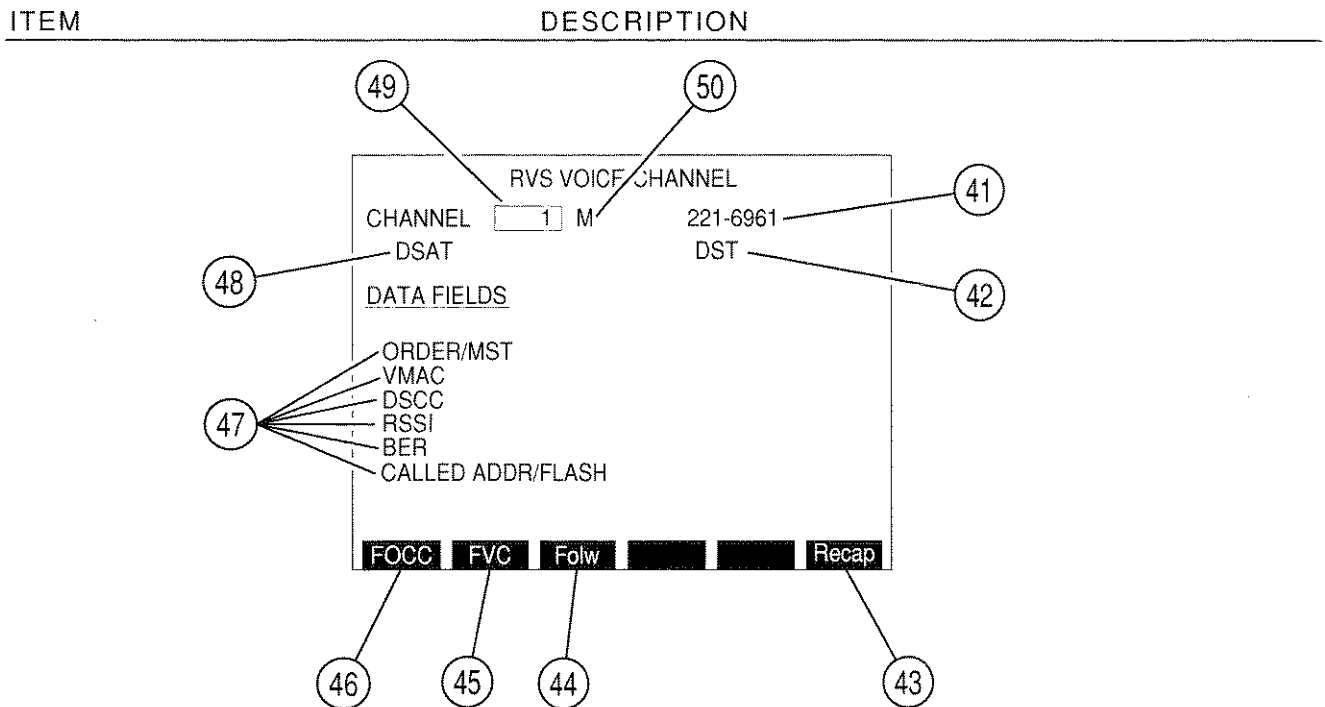

03416152

### 41. MIN

Displays MIN (Mobile Identification Number) of cellular phone in use on this Reverse Voice Channel.

### 42. DST

Displays DST in hexadecimal.

### 43. "Recap"/"ESC" Soft Function Key F6

"ESC" appears while parameters are accessed for editing. Allows edit procedure to be canceled without changing parameter. Press "Recap" Soft Function Key F6 to restart Capture Function initiated from the Forward Control Channel Screen.

### 44. "Folw" Soft Function Key F3

Press "Folw" Soft Function Key F3 to activate the Follow function. When Follow is enabled, operation is returned to the Forward Control Channel Screen when a call being monitored is dropped. "Folw" appears in red when active.

### 45. "FVC" Soft Function Key F2

Press "FVC" Soft Function Key F2 to display the Forward Voice Channel Screen.

### 46. "FOCC" Soft Function Key F1

Press "FOCC" Soft Function Key F1 to display the Forward Control Channel Screen.

## ITEM

## DESCRIPTION

47. Reverse Voice Channel Data Fields● ORDER/MST

Displays the order or message sent from the Mobile Phone. Messages are displayed in hexadecimal as follows:

MESSAGE TYPE	HEX BIT PATTERN
NAMPS Channel Assignment	80
Voice Mail	82
CLI (Call Line Identifier) Order	84
Short Message	85
Short Message Full	83
NAMPS Origination or Page Response	00
Not capable of last extended protocol message	07

● VMAC

Displays current Mobile Station power attenuation code.

● DSCC

Displays current DSAT Color Code.

● RSSI

Displays current Received Signal Strength.

● BER

Displays current number of bit errors.

● CALLED ADDR/FLASH

Displays number the Mobile Phone is calling.

48. DSAT

Displays DSAT in hexadecimal. DST is logical inverse of DSAT.

49. CHANNEL

Selects Reverse Voice Channel to monitor. Range is from 1 to 1023. Use DATA ENTRY Keypad (29) or DATA SCROLL to enter a channel and press ENTER Key.

50. U/M/L

Selects Upper (10 kHz above channel frequency), Middle (actual channel frequency) or Lower (10 kHz below channel frequency). Move cursor to U and press ENTER Key. Use DATA SCROLL ↑ Key (3) to set U, M or L and press ENTER Key.

## 7-2 AMPS/NAMPS CELLULAR SIMULATION

The AMPS/NAMPS Cellular Simulation is a series of screens that allow the user to transmit and manipulate the content of orders from a simulated Cell Site or Mobile Phone. The transmissions consist of either single bursts that are non-looping (may be repeatedly sent by the user's repetitive initiations) or when, repeat mode is engaged for a channel, be transmitted continuously until interrupted by the user. The orders may be transmitted on a selected Forward Control Channel, Reverse Control Channel, Forward Voice Channel or Reverse Voice Channel. See Figure 7-2 for an illustration of the AMPS/NAMPS Cellular Simulation Screen hierarchy.

Pressing "Cellr" Soft Function Key F3 from the RF Generator Menu accesses the Cellular Simulation Main Menu:

MENU ITEM	DESCRIPTION
-----------	-------------

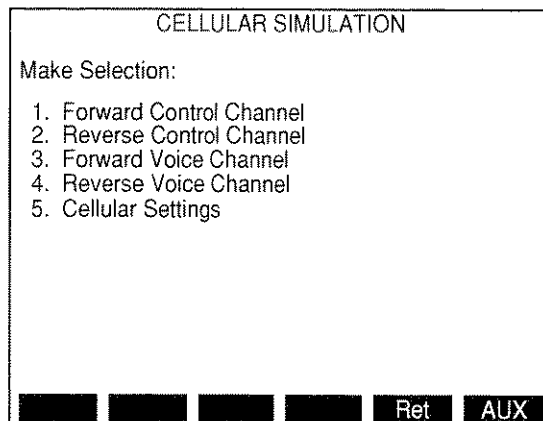

8610216

### 1. Forward Control Channel

Selects the Forward Control Channel Cell Site Simulation Screen. The Forward Control Channel Simulation Screen allows for control of the Overhead Message, Global Action Overhead Message and Mobile Control Message. Supports the extended protocol for NAMPS which includes Voice Mail, Short Message and Call Indicator. See 7-2-1.

### 2. Reverse Control Channel

Selects the Reverse Control Channel Mobile Simulation Screen. The Reverse Control Channel Simulation Screen sends a Page Response, Autonomous Registration, Audit or Origination order on the selected Reverse Control Channel. Supports the extended protocol for NAMPS. Allows the entry of the simulated Mobile Phones MIN, ESN, Power Class and Bandwidth. See 7-2-2.

### 3. Forward Voice Channel

Selects the Forward Voice Channel Cell Site Simulation Screen. The Forward Voice Channel Simulation Screen allows the entry of orders and associated information elements. The Forward Voice Channel Simulation Screen supports both AMPS and NAMPS (including DSAT/DST) protocols. See 7-2-3A and 7-2-3B.



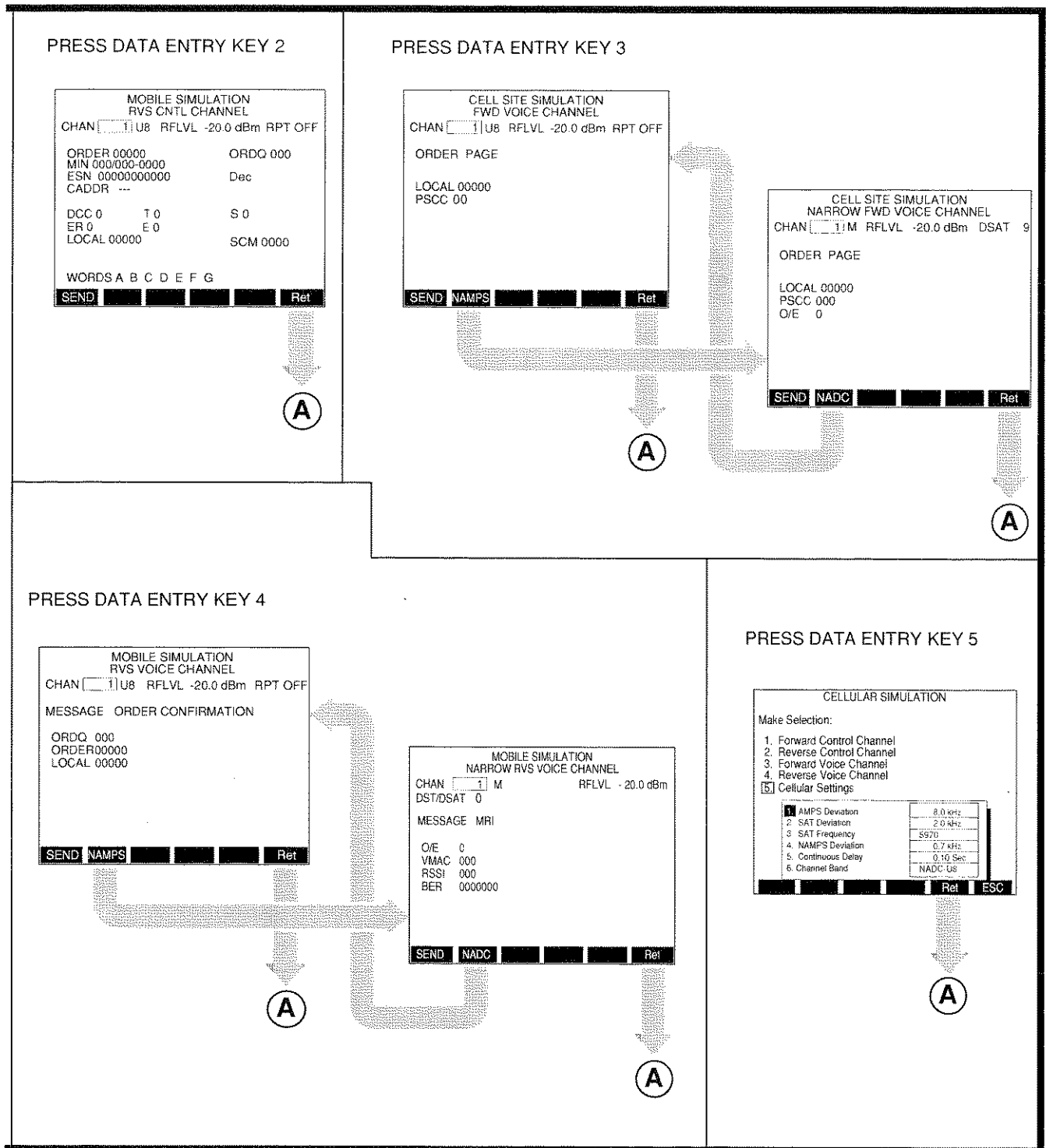

03401005

Figure 7-2 AMPS/NAMPS Cellular Simulation Screen Hierarchy

MENU ITEM

DESCRIPTION

---

4. Reverse Voice Channel

Selects the Reverse Voice Channel Mobile Simulation Screen. The Reverse Voice Channel Simulation Screen sends orders and order confirmations on the selected Reverse Voice Channel. Allows the entry of the simulated Mobile Phones ESN and Called Address. The Reverse Voice Channel Simulation Screen supports both AMPS and NAMPS (including DSAT/DST) protocols. See 7-2-4A and 7-2-4B.

5. Cellular Settings

Allows the entry of AMPS data frequency Deviation, SAT Deviation, SAT Frequency, NAMPS data frequency Deviation, Continuous Delay and NADC Channel Band settings. See 7-2-5.

## 7-2-1 FORWARD CONTROL CHANNEL CELL SITE SIMULATION SCREEN

To access, press 1 DATA ENTRY Key (29) from the Cellular Simulation Main Menu. The Forward Control Channel Simulation Screen appears:

ITEM	DESCRIPTION
------	-------------

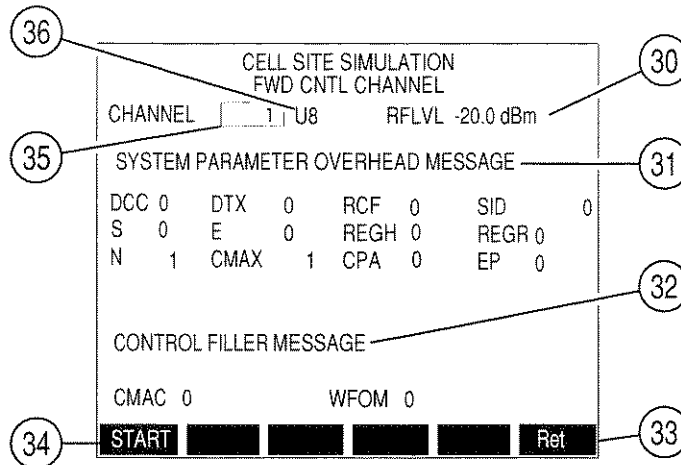

03416132

### 30. RFLVL

Displays the transmission RF Level. Move cursor to RFLVL and press ENTER Key. Use DATA ENTRY Keypad (29) to enter a desired value and press ENTER Key. Range is -137.0 to 0.0 dBm.

**NOTE:** Items 30, 39, 53, 62, 90, 101, 112 and 113 perform the same function.

### 31. SYSTEM PARAMETER OVERHEAD MESSAGE

The System Parameter Overhead Message is the first message sent in the Overhead Message Train. The following items are data fields in the System Parameter Overhead Message:

- DCC

DCC (Digital Color Code). To be retransmitted by a receiving Mobile Phone to identify which Cell Site the Mobile Phone is receiving. Move cursor to DCC and press ENTER Key. Use DATA ENTRY Keypad (29) to enter desired value and press ENTER Key. Range is 0 to 3.

- S

S (Serial Number) bit is 1 if Mobile Phone must send Serial Number to access the system; 0 otherwise. Move cursor to S and press ENTER Key to toggle between 1 and 0.

- N

N is the number of paging channels the Mobile Phone must scan. Move cursor to N and press ENTER Key. Use DATA ENTRY Keypad (29) to enter desired value and press ENTER Key. Range is 1 to 32.

- DTX

DTX (Discontinuous Transmission) values identify how the Mobile Phone is allowed to use discontinuous transmission. Move cursor to DTX and press ENTER Key. Use DATA ENTRY Keypad (29) to enter desired value and press ENTER Key. DTX values and definitions are as follows:

DTX VALUES	DEFINITION
0	DTX not allowed
1	Undefined
2	Low level $\geq 8$ dB below high level
3	No minimum for low level

- E

E (Extended Address) bit is 1 if Mobile Phone must send MIN1 and MIN2; 0 if Mobile Phone needs to send MIN1 only. MIN1 is the 24 bits corresponding to the 7 digit telephone number. MIN2 is the 10 bits corresponding to the 3 digit area code. Move cursor to E and press ENTER Key to toggle between 1 and 0.

- CMAx

CMAx is the maximum number of Channels to be scanned by Mobile Phone when accessing a system. Move cursor to CMAx and press ENTER Key. Use DATA ENTRY Keypad to enter desired value and press ENTER Key. Range is 1 to 128.

- RCF

RCF (Read Control Filler) bit is 1 if Mobile Phone must read the Control Filler message before accessing the system; 0 otherwise. Move cursor to RCF and press ENTER Key to toggle between 1 and 0.

- REGH

REGH (Registration for Home Stations) is 1 to allow the Mobile Phone to perform a registration in the home system of the Mobile Phone; 0 otherwise. Move cursor to REGH and press ENTER Key to toggle between 1 and 0.

- CPA

CPA (Combined Paging/Access) bit is 1 if access functions and paging functions are on the same set of Control Channels; 0 otherwise. Move cursor to CPA and press ENTER Key to toggle between 1 and 0.

- SID

SID is the System Identification number of the Cell Site. This parameter identifies the Cell Site. Move cursor to SID and press ENTER Key. Use DATA ENTRY Keypad to enter desired value and press ENTER Key. Range is 0 to 32767.



## ITEM

## DESCRIPTION

● REGR

REGR (Registration for Roaming Mobile Phones) is 1 to allow a roaming Mobile Phone to perform registration; 0 otherwise. Move cursor to REGR and press ENTER Key to toggle between 1 and 0.

● EP

EP (Extended Protocol) bit indicating if Mobile Phone is capable of NAMPS protocol (1 if NAMPS protocol used, 0 if AMPS protocol used). Move cursor to EP and press ENTER Key to toggle between 1 and 0.

32. CONTROL FILLER MESSAGE

The Control Filler Message is sent on the Forward Control Channel in the absence of any other message being sent. The following items are data fields in the Control Filler Message:

● CMAC

CMAC (Control Mobile Attenuation Code) specifies maximum power level allowed for Mobile Phone transmitting on Reverse Control Channel. Eight power level are selectable. Move cursor to CMAC and press ENTER Key. Use DATA ENTRY Keypad to enter desired value and press ENTER Key. Range is 0 to 7.

● WFOM

WFOM (Wait For Overhead Message) bit is 1 if Mobile Phone must wait for Overhead Message before transmitting on the Reverse Control Channel; 0 otherwise. Move cursor to WFOM and press ENTER Key to toggle between 1 and 0.

33. "Ret"/"ESC" Soft Function Key F6

"ESC" appears while parameters are accessed for editing. Allows edit procedure to be canceled leaving parameter unchanged. "Ret" returns operation to the Cellular Simulation Main Menu.

34. "START"/"STOP" Soft Function Key F1

Press "START" to start transmitting the Overhead Message Train.

The Overhead Message Train is sent to the Mobile Phone repeatedly until "STOP" is pressed. The Overhead Message Train nominally consists of 2 System Parameter words followed by 14 Control-Filler words.

35. CHANNEL

Select Channel on which to transmit. See the following table for range of channels. AMPS Channels 313 to 354 are usually Control Channels. AMPS Channels 313 to 333 are System A channels and channels 334 to 354 are System B channels. Move cursor to CHANNEL and press ENTER Key. Use DATA ENTRY Keypad (29) to enter a channel number and press ENTER Key.

NADC BAND	RANGE OF CHANNELS	FREQUENCY BAND
U8 (AMPS)	1 to 1023	800 MHz
U4 (NT400©)	1 to 333	450 MHz
HY (Hyperband)	1 to 1999	1900 MHz

**NOTE:** Items 35, 45, 51, 60, 88 and 110 perform the same function.

36. NADC Band

Select NADC band. See the preceding table for NADC bands. Move cursor to band indication and press ENTER Key to activate data field. Press DATA SCROLL ↑ Key (3) to select desired band.

**NOTE:** Items 36, 46, 52, 61, 89 and 111 perform the same function.

When "START" Soft Function Key F1 is pressed, the Overhead Message Train begins transmitting and Soft Function Keys F4 and F5 appear as follows:

ITEM	DESCRIPTION
------	-------------

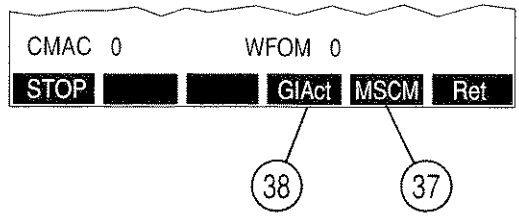

03416133

37. "MSCM" Soft Function Key F4

When pressed, the Mobile Control Message screen appears.

38. "GIAct" Soft Function Key F5

When pressed, the Global Action Overhead Message screen appears.

When "GIAct" Soft Function Key F4 is pressed, the Global Action Overhead Message screen appears:

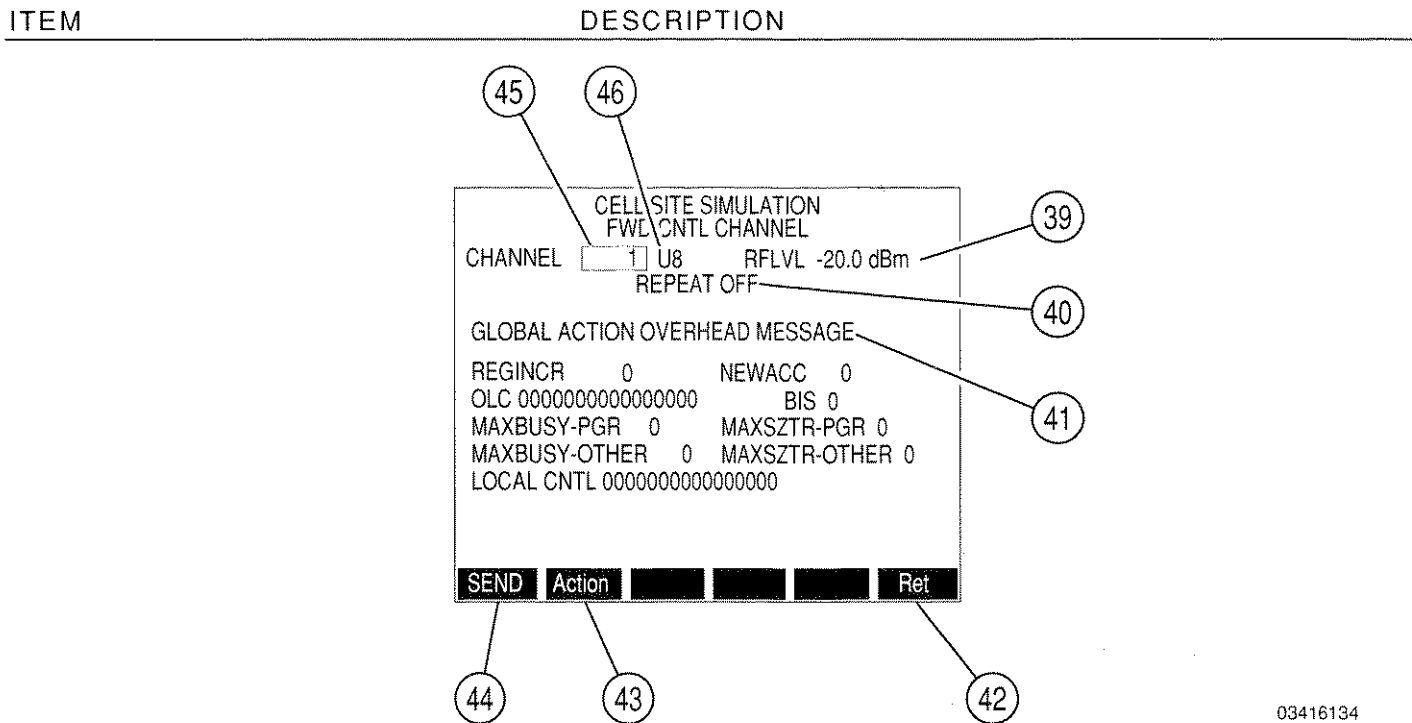

03416134

39. RFLVL

Displays the transmission RF Level. Move cursor to RFLVL and press ENTER Key. Use DATA ENTRY Keypad (29) to enter a desired value and press ENTER Key. Range is -137.0 to 0.0 dBm.

**NOTE:** Items 30, 39, 53, 62, 90, 101, 112 and 113 perform the same function.

40. REPEAT

Toggles between "OFF" and "ON." When REPEAT is "ON," the Overhead Message Train with an appended Global Action Overhead Message is transmitted continuously when "SEND" Soft Function Key F1 is pressed. Move cursor to REPEAT and press ENTER Key to toggle between 1 and 0.

**NOTE:** The continuous transmission may be halted by pressing "SEND" Soft Function Key F1, again.

41. GLOBAL ACTION OVERHEAD MESSAGE

The Global Action Overhead Message is appended to the System Parameter Overhead Message in the Overhead Message Train. The following items are data fields in the Global Action Overhead Message:

- REGINCR

REGINCR (Registration Increment) bit identifies increments between Mobile Phone registrations. Move cursor to REGINCR and press ENTER Key. Use DATA ENTRY Keypad (29) to enter a desired value and press ENTER Key. Range is 0 to 4095.

## ITEM

## DESCRIPTION

● OLC

OLC (Overload Control Class). Mobile Phones are assigned 1 or more of 16 possible control fields. Each 1 represents an allowed field, each 0 represents a restricted field. Move cursor to OLC and press ENTER Key. Use DATA ENTRY Keypad (29) to enter desired value for 16 bit word. Press ENTER Key.

● MAXBUSY-PGR

Maximum number of Busy occurrences allowed for Page Responses. Move cursor to MAXBUSY-PGR and press ENTER Key. Use DATA ENTRY Keypad (29) to enter a desired value and press ENTER Key. Range is 0 to 15.

● MAXBUSY-OTHER

Maximum number of Busy occurrences allowed for Other accesses. Move cursor to MAXBUSY-OTHER and press ENTER Key. Use DATA ENTRY Keypad (29) to enter a desired value and press ENTER Key. Range is 0 to 15.

● LOCAL CNTL

Local Control message is a 16 bit, user-defined local control message sent to the Mobile Phone. Move cursor to LOCAL CNTL and press ENTER Key. Use DATA ENTRY Keypad (29) to enter desired value for 16 bit word. Press ENTER Key.

● NEWACC

NEWACC (New Access Channel starting point) is the new first access channel sent in a New Access Channel Global Access message. Move cursor to NEWACC and press ENTER Key. Use DATA ENTRY Keypad (29) to enter a desired value and press ENTER Key. Range is 0 to 2047.

● BIS

BIS (Busy-Idle Status) bit is 1 if Mobile Phone must check for idle-to-busy transition on Reverse Control Channel when accessing. Move cursor to BIS and press ENTER Key to toggle between 1 and 0.

● MAXSZTR-PGR

Maximum number of Seizure attempts allowed for Page Responses. Move cursor to MAXSZTR-PGR and press ENTER Key. Use DATA ENTRY Keypad (29) to enter a desired value and press ENTER Key. Range is 0 to 15.

● MAXSZTR-OTHER

Maximum number of Seizure attempts allowed for Other accesses. Move cursor to MAXSZTR-OTHER and press ENTER Key. Use DATA ENTRY Keypad (29) to enter a desired value and press ENTER Key. Range is 0 to 15.

## ITEM

## DESCRIPTION

42. "Ret"/"ESC" Soft Function Key F6

"Ret" returns operation to the Cellular Simulation Main Menu. "ESC" appears while parameters are accessed for editing. Allows edit procedure to be canceled leaving parameter unchanged.

43. "Action" Soft Function Key F2

When pressed, displays the Global Action Overhead Message menu.

44. "SEND" Soft Function Key F1

Pressing "SEND" appends the Global Action messages to the System Parameter Overhead Message in the Overhead Message Train initiated by the "START" (34) command. Control-Filler messages complete the 16 word Overhead Message Train transmitted.

If REPEAT (40) is on, the Overhead Message Train containing Global Action messages selected is repeatedly sent until "SEND" is pressed, again.

If REPEAT (40) is off, the Global Action messages are sent once. Once the Global Action message is stopped, the Overhead Message Train continue to transmit as originally instructed by the "START" (34) command.

45. CHANNEL

Select Channel on which to transmit. See the following table for range of channels. AMPS Channels 313 to 354 are usually Control Channels. AMPS Channels 313 to 333 are System A channels and channels 334 to 354 are System B channels. Move cursor to CHANNEL and press ENTER Key. Use DATA ENTRY Keypad (29) to enter a channel number and press ENTER Key.

NADC BAND	RANGE OF CHANNELS	FREQUENCY BAND
U8 (AMPS)	1 to 1023	800 MHz
U4 (NT400©)	1 to 333	450 MHz
HY (Hyperband)	1 to 1999	1900 MHz

**NOTE:** Items 35, 45, 51, 60, 88 and 110 perform the same function.

46. NADC Band

Select NADC band. See the following table for NADC bands. Move cursor to band indication and press ENTER Key to activate data field. Press DATA SCROLL ↑ Key (3) to select desired band.

**NOTE:** Items 36, 46, 52, 61, 89 and 111 perform the same function.

When "Action" Soft Function Key F2 is pressed, the Global Action Overhead Message menu appears:

ITEM

DESCRIPTION

```

CELL SITE SIMULATION
FWD CNTL CHANNEL
CHANNEL [ 1 ] U8   RFLVL -20.0 dBm
REPEAT OFF
1. RESCAN           Off
GLC 2. REG INC      Off   AGE
3. NEW ACCESS      Off
REG 4. OVERLOAD    Off   0
OLC 5. ACCESS TYPE Off   0
MAX 6. ACCESS ATTEMPT Off  GR 0
MAX 7. LOCAL CNTL 1 Off  DTHR 0
LOC 8. LOCAL CNTL 2 Off
ON OFF Esc Ret
    
```

03416135

Following are the Global Action messages definitions and their fields. Global Action messages are sent to the Mobile Phone from the Global Action screen of the Cell Site Simulation.

The relevant fields are those fields edited from the Global Action screen that are used with the message. Fields that must be set to a certain value are not selectable and are not listed.

Press "ESC" Soft Function Key F5 to return to Global Action screen.

1. RESCAN

The Rescan message instructs the Mobile Phone to stop its present task and rescan the dedicated Control Channels. This message has no selectable fields. Move cursor to RESCAN. Press Soft Key F1 to turn RESCAN on or Soft Key F2 to turn RESCAN off.

2. REG INC

The Registration Increment message updates the Mobile Phone's REGINCR value. Move cursor to REG INC. Press Soft Key F1 to turn REG INC on or Soft Key F2 to turn REG INC off.

FIELD	DESCRIPTION
REGINCR	The increment for the Mobile Phone to add to the registration ID when performing autonomous registrations.

3. NEW ACCESS

The New Access channel set message provides the Mobile Phone with a new first access channel. This channel is used by the Mobile Phone to determine a new set of access channels. Move cursor to NEW ACCESS. Press Soft Key F1 to turn NEW ACCESS on or Soft Key F2 to turn NEW ACCESS off.

FIELD	DESCRIPTION
NEWACC	The first access channel

4. OVERLOAD

The Overload Control message informs selected Mobile Phones that the current control channel cannot be accessed. Each Mobile Phone monitors one OLC bit when receiving an Overload message. If the Mobile Station's OLC bit is set to 0, the Mobile Phone is not allowed to access the current control channel of the sending Cell Site. Move cursor to OVERLOAD. Press Soft Key F1 to turn OVERLOAD on or Soft Key F2 to turn OVERLOAD off.

FIELD	DESCRIPTION
OLC 0	Overload Class bit 0
OLC 1	Overload Class bit 1
OLC 2	Overload Class bit 2
OLC 3	Overload Class bit 3
OLC 4	Overload Class bit 4
OLC 5	Overload Class bit 5
OLC 6	Overload Class bit 6
OLC 7	Overload Class bit 7
OLC 8	Overload Class bit 8
OLC 9	Overload Class bit 9
OLC 10	Overload Class bit 10
OLC 11	Overload Class bit 11
OLC 12	Overload Class bit 12
OLC 13	Overload Class bit 13
OLC 14	Overload Class bit 14
OLC 15	Overload Class bit 15



## ITEM

## DESCRIPTION

5. ACCESS TYPE

The Access Type parameter message updates the BIS field of the Mobile Phone. Move cursor to ACCESS TYPE. Press Soft Key F1 to turn ACCESS TYPE on or Soft Key F2 to turn ACCESS TYPE off.

FIELD	DESCRIPTION
BIS	BIS is set to 1 if the Mobile Phone must monitor the Reverse Control Channel status when originating a call.

6. ACCESS ATTEMPT

The Access Attempt parameters message updates the maximum busy occurrences and number of seizure tries allowed. If this access is a Page response, the MAXBUSY-PGR and MAXSZTR-PGR fields are updated; otherwise, the MAXBUSY-OTHER and MAXSZTR-OTHER fields are updated. Move cursor to ACCESS ATTEMPT. Press Soft Key F1 to turn ACCESS ATTEMPT on or Soft Key F2 to turn ACCESS ATTEMPT off.

FIELD	DESCRIPTION
MAXBUSY-PGR	Maximum number of busy occurrences allowed for Page responses.
MAXSZTR-PGR	Maximum number of seizure tries allowed for Page responses.
MAXBUSY-OTHER	Maximum number of busy occurrences allowed for other responses.
MAXSZTR-OTHER	Maximum number of seizure tries allowed for other responses.

7. LOCAL CNTL 1

The Local Control 1 message allows customized messages to be sent to the Mobile Phone. Move cursor to LOCAL CNTL 1. Press Soft Key F1 to turn LOCAL CNTL 1 on or Soft Key F2 to turn LOCAL CNTL 1 off.

FIELD	DESCRIPTION
LOCAL CNTL	16 bit local control message

**ITEM****DESCRIPTION**

---

**8. LOCAL CNTL 2**

The Local Control 2 message allows customized messages to be sent to the Mobile Phone. Move cursor to LOCAL CNTL 2. Press Soft Key F1 to turn LOCAL CNTL 2 on or Soft Key F2 to turn LOCAL CNTL 2 off.

<b>FIELD</b>	<b>DESCRIPTION</b>
LOCAL CNTL	16 bit local control message

When "MSCM" Soft Function Key F5 is pressed, the Mobile Station Control Message screen appears:

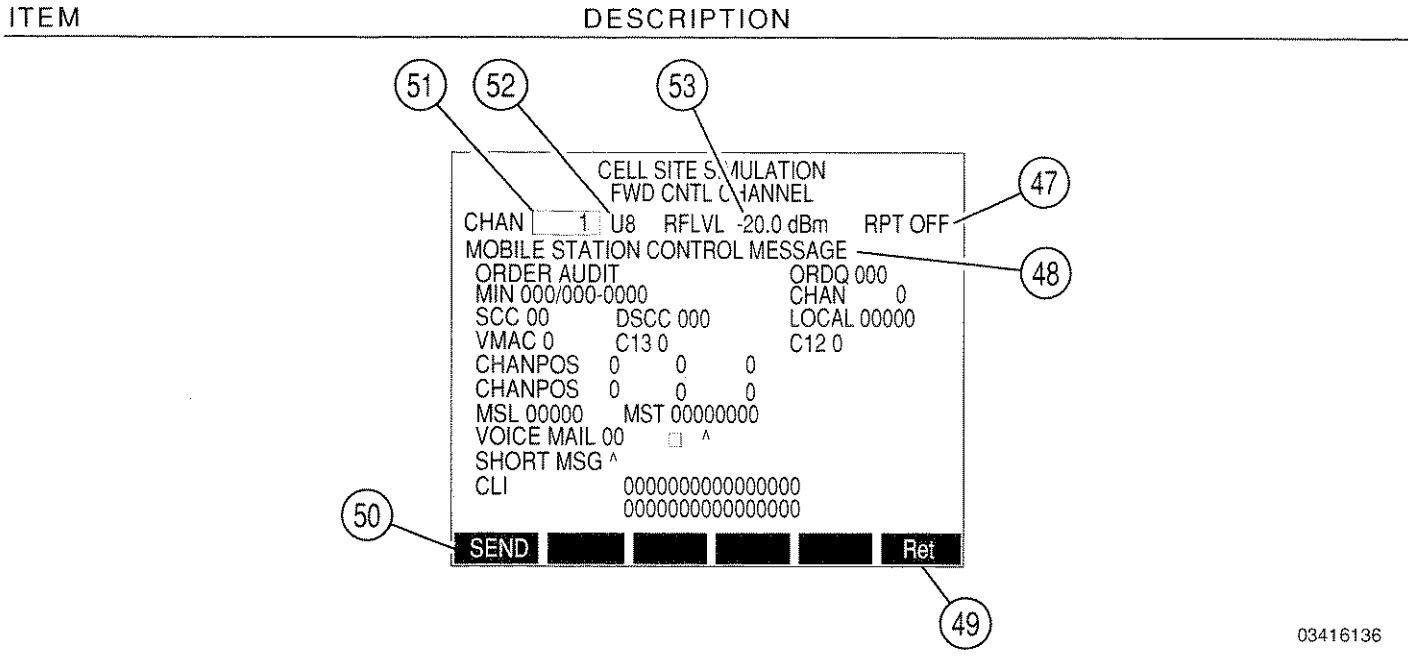

03416136

47. RPT

RPT (Repeat) toggles between "OFF" and "ON." When RPT is "ON," the Mobile Station Control Message is transmitted continuously when "SEND" Soft Function Key F1 is pressed. Move cursor to RPT and press ENTER Key to toggle between on and off.

**NOTE:** The System Parameter Overhead Message and any appended Global Action Overhead Message in the Overhead Message Train is omitted when a Mobile Station Control Message is sent. The continuous transmission of the Mobile Station Control Message may be halted by pressing "SEND" Soft Function Key F1, again. The System Parameter Overhead Message and any appended Global Action Overhead Message is, again, sent in the Overhead Message Train once the Mobile Station Control Message is halted.

48. MOBILE STATION CONTROL MESSAGE

Mobile Station Control Messages, when sent, replace the System Parameter Overhead Message and any appended Global Action Overhead Message in the Overhead Message Train. The following items are data fields in the Mobile Station Control Message:

- ORDER

Displays the order or message transmitted to the Mobile Phone. The following orders are available: AUDIT, LOCAL CONTROL, DIR RETRY, INTERCEPT, RELEASE, REORDER, VC DES and EXTENDED. Move cursor to ORDER and press ENTER Key. Use DATA SCROLL ↑ Key (3) to select desired order or message and press ENTER Key.

## ITEM

## DESCRIPTION

● ORDQ

ORDQ (Order Qualifier) qualifies the order to a specific action. Move cursor to ORDQ and press ENTER Key. Use DATA ENTRY Keypad (29) to enter desired value for 3 bit word. Press ENTER Key.

● MIN

MIN (Mobile Identification Number) is the telephone number identifying the Mobile Phone. Use digits 0 to 9, # or \*. Move cursor to MIN and use DATA ENTRY Keypad (29) to enter desired MIN. Press ENTER Key.

● CHAN

CHAN is the Voice Channel a call is assigned to, initially or due to a handoff. Move cursor to CHAN and press ENTER Key. Use DATA ENTRY Keypad (29) to enter desired value and press ENTER Key. Range is 1 to 2047.

● SCC

SCC (Supervisory Audio Tone Color Code) indicates the SAT frequency the Cell Site is transmitting according to the following table. Move cursor to SCC and press ENTER Key. Use DATA ENTRY Keypad (29) to enter desired value for 2 bit word. Press ENTER Key.

SCC	SAT FREQ (Hz)
00	5970
01	6000
10	6030
11	undefined

## ITEM

## DESCRIPTION

● DSCC

DSCC (DSAT Color Code) for new channel is used to verify received DSAT. Move cursor to DSCC and press ENTER Key. Use DATA ENTRY Keypad (29) to enter desired value for 3 bit word. Press ENTER Key.

DSAT	DSCC
2556CB	000
255B2B	001
256A9B	010
25AD4D	011
26AB2B	100
26B2AD	101
2969AB	110

DSCC also represents SCC for a handoff to a Wide Analog (AMPS) channel as follows:

SAT	DSCC
00	000
01	001
10	010

● LOCAL

Used to transmit binary message that is of user-defined value and functionality. Move cursor to LOCAL and press ENTER Key. Use DATA ENTRY Keypad (29) to enter desired value for 5 bit word. Press ENTER Key.

- VMAC

VMAC (Voice Mobile Attenuation Code) sets initial Mobile Phone power level when assigning Mobile Phone to a Voice Channel. Move cursor to VMAC and press ENTER Key. Use DATA ENTER Keypad (29) to enter desired value and press ENTER Key. Range is 0 to 7. VMAC is implemented as follows:

DESCRIPTION	VMAC
Power level 0	0
Power level 1	1
Power level 2	2
Power level 3	3
Power level 4	4
Power level 5	5
Power level 6	6
Power level 7	7

- C13

Channel number bit 13. C12 and C13 indicate band used according to the following table. Move cursor to C13 or C12 and press ENTER Key to toggle between 1 and 0.

C12	C13	NAMPS BAND
0	1	Upper
0	0	Middle
1	0	Lower

- C12

Channel number bit 12. See C13.

- CHANPOS (1)

CHANPOS (Channel Position 1) is the channel position of access channel 1, 2 and 3 relative to the first access channel (from Word 3 of the Directed Retry message). Move cursor to any of the CHANPOS data fields and press ENTER Key. Use DATA ENTRY Keypad (29) to enter desired value and press ENTER Key. Range is 0 to 127.

## ITEM

## DESCRIPTION

● CHANPOS (2)

CHANPOS (Channel Position 2) is the channel position of access channel 4, 5 and 6 relative to the first access channel (from Word 4 of the Directed Retry message). Move cursor to any of the CHANPOS data fields and press ENTER Key. Use DATA ENTER Keypad (29) to enter desired value and press ENTER Key. Range is 0 to 127.

● MSL

MSL (Message Length or Extended Protocol Message Length) displays number of messages coming (not counting the first message) as 2 decimal digits. Move cursor to MSL and press ENTER Key. Use DATA ENTRY Keypad (29) to enter desired value for 5 bit word. Press ENTER Key.

● MST

Message Types (Extended Protocol Message Type). Move cursor to MST and press ENTER Key. Use DATA ENTRY Keypad (29) to enter desired value for 8 bit word. Press ENTER Key. MST implemented in hexadecimal form as follows:

MESSAGE TYPE	HEX BIT PATTERN
NAMPS Channel Assignment	80
Voice Mail	82
CLI (Call Line Identifier) Order	84
Short Message	85
Short Message Full	83
NAMPS Origination or Page Response	00
Not capable of last extended protocol message	07

49. "Ret"/"ESC" Soft Function Key F6

"Ret" returns operation to the System Parameter Overhead Message screen portion of the Forward Control Channel Cellular Simulation. "ESC" appears while parameters are accessed for editing. Allows edit procedure to be canceled leaving parameter unchanged.

50. "SEND" Soft Function Key F1

When pressed, the Mobile Station Control Message is sent consisting of the message (2 to 5 words) followed by the number of Control-Filler words needed for a total of 16 words.

If RPT (Repeat) is off, the Mobile Station Control Message is sent only once. If RPT is on, the Mobile Station Control Message is sent repeatedly until "SEND" is pressed, again.

**NOTE:** The System Parameter Overhead Message and any appended Global Action Overhead Message in the Overhead Message Train is omitted when a Mobile Station Control Message is sent. The System Parameter Overhead Message and any appended Global Action Overhead Message is, again, sent in the Overhead Message Train once the Mobile Station Control Message is halted.

51. CHANNEL

Select Channel on which to transmit. See the following table for range of channels. AMPS Channels 313 to 354 are usually Control Channels. AMPS Channels 313 to 333 are System A channels and channels 334 to 354 are System B channels. Move cursor to CHANNEL and press ENTER Key. Use DATA ENTRY Keypad (29) to enter a channel number and press ENTER Key.

NADC BAND	RANGE OF CHANNELS	FREQUENCY BAND
U8 (AMPS)	1 to 1023	800 MHz
U4 (NT400 <sup>©</sup> )	1 to 333	450 MHz
HY (Hyperband)	1 to 1999	1900 MHz

**NOTE:** Items 35, 45, 51, 60, 88 and 110 perform the same function.

52. NADC Band

Select NADC band. See the following table for NADC bands. Move cursor to band indication and press ENTER Key to activate data field. Press DATA SCROLL ↑ Key (3) to select desired band.

**NOTE:** Items 36, 46, 52, 61, 89 and 111 perform the same function.

53. RFLVL

Displays the transmission RF Level. Move cursor to RFLVL and press ENTER Key. Use DATA ENTRY Keypad (29) to enter a desired value and press ENTER Key. Range is -137.0 to 0.0 dBm.

**NOTE:** Items 30, 39, 53, 62, 90, 101, 112 and 113 perform the same function.



ITEM

DESCRIPTION

The following items are part of the NAMPS Extended Protocol Enhanced Services and are sent in a Mobile Station Control Message:

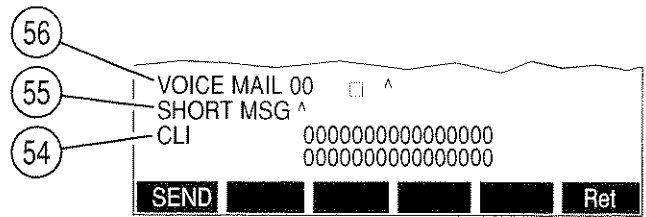

03416137

54. CLI

CLI (Call Line Identifier) identifies the person that is calling the Mobile Phone. Move cursor to CLI and press ENTER Key. Use DATA ENTRY Keypad (29) or DATA SCROLL ↑ Key (3) (in combination with FIELD SELECT ← or → Keys to position small cursor) to enter desired characters and press ENTER Key. Allowable character set is 0-9, N, # and \* (32 characters maximum).

55. SHORT MSG

Used to transmit single short message of 1 to 15 characters in length or multiple short messages linked together. A special STX character (\ - backslash) may be used to link a message to the previous message sent. A special ETX character (^ - caret) may be used in any short message to mark the end of the message. Move cursor to SHORT MSG and press ENTER Key. Use DATA ENTRY Keypad (29) or DATA SCROLL ↑ Key (3) (in combination with FIELD SELECT ← or → Keys to position small cursor) to enter desired message and press ENTER Key. Each character may be any of the allowable character set defined in Appendix A of IS-88.

56. VOICE MAIL

Consists of three user-definable fields:

- Number of unanswered messages. Move cursor to the 2 digit field immediately to the right of the VOICE MAIL label and press ENTER Key. Use DATA ENTRY Keypad (29) to enter desired value and press ENTER Key. Range is 00 to 99.
- Urgent message identifier. Move cursor to the 2nd field to the right of the VOICE MAIL label and press ENTER Key to toggle between "!" (exclamation point) or □ (space).
- Message. Move cursor to the 3rd field to the right of the VOICE MAIL label and press ENTER Key. Use DATA ENTRY Keypad (29) or DATA SCROLL ↑ Key (3) (in combination with FIELD SELECT ← or → Keys to position small cursor) to enter desired message and press ENTER Key. Message may consist of 1 to 11 characters in length, each of which may be any of the allowable character set defined in Appendix A of IS-88.

## 7-2-2 REVERSE CONTROL CHANNEL MOBILE SIMULATION SCREEN

The Reverse Control Channel Simulation Screen simulates a Mobile Phone by generating a Page Response, Origination, Audit or an Autonomous Registration message. To access, press 2 DATA ENTRY Key (29) from the Cellular Simulation Main Menu. The Reverse Control Channel Simulation Screen appears:

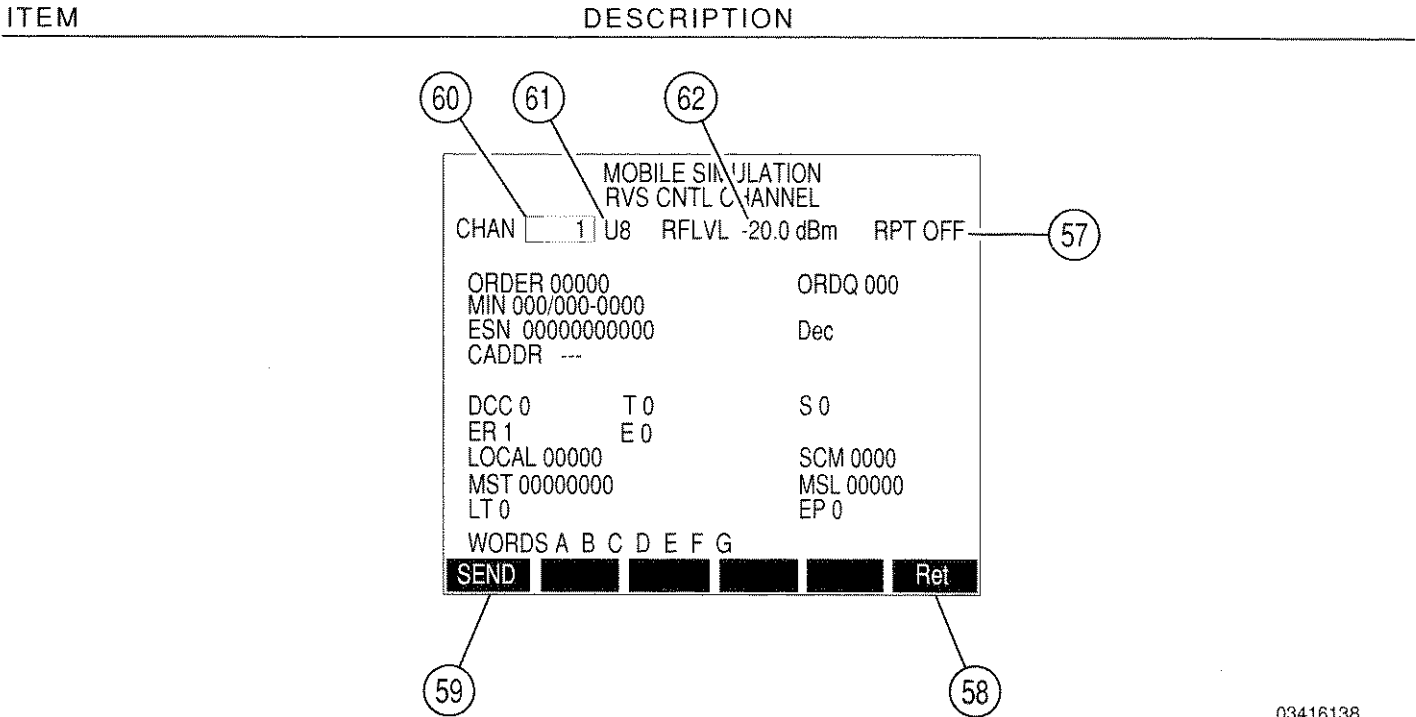

03416138

### 57. RPT

When RPT (Repeat) is "ON," the message is transmitted continuously when "SEND" Soft Function Key F1 is pressed. Move cursor to RPT and press ENTER Key to toggle between on and off.

**NOTE:** The continuous transmission of the message may be halted by pressing "SEND" Soft Function Key F1, again.

### 58. "Ret"/"ESC" Soft Function Key F6

"Ret" returns operation to the Cellular Simulation Main Menu. "ESC" appears while parameters are accessed for editing. Allows edit procedure to be canceled leaving parameter unchanged.

### 59. "SEND" Soft Function Key F1

When pressed, the message is sent.

If RPT (Repeat) is off, the message is sent only once. If RPT is on, the message is sent repeatedly until "SEND" is pressed, again.

## ITEM

## DESCRIPTION

60. CHANNEL

Select Channel on which to transmit. See the following table for range of channels. AMPS Channels 313 to 354 are usually Control Channels. AMPS Channels 313 to 333 are System A channels and channels 334 to 354 are System B channels. Move cursor to CHANNEL and press ENTER Key. Use DATA ENTRY Keypad (29) to enter a channel number and press ENTER Key.

NADC BAND	RANGE OF CHANNELS	FREQUENCY BAND
U8 (AMPS)	1 to 1023	800 MHz
U4 (NT400©)	1 to 333	450 MHz
HY (Hyperband)	1 to 1999	1900 MHz

**NOTE:** Items 35, 45, 51, 60, 88 and 110 perform the same function.

61. NADC Band

Select NADC band. See the preceding table for NADC bands. Move cursor to band indication and press ENTER Key to activate data field. Press DATA SCROLL ↑ Key (3) to select desired band.

**NOTE:** Items 36, 46, 52, 61, 89 and 111 perform the same function.

62. RFLVL

Displays the transmission RF Level. Move cursor to RFLVL and press ENTER Key. Use DATA ENTRY Keypad (29) to enter a desired value and press ENTER Key. Range is -137.0 to 0.0 dBm.

**NOTE:** Items 30, 39, 53, 62, 90, 101, 112 and 113 perform the same function.

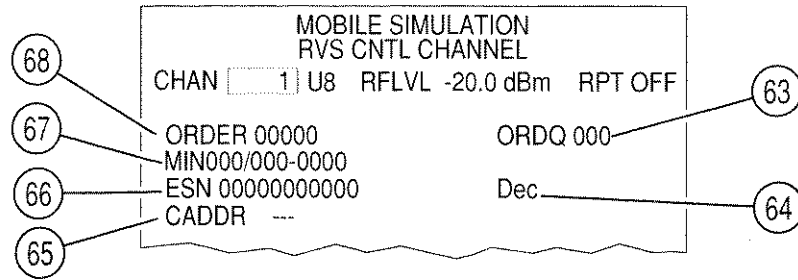

03416139

63. ORDQ

Order Qualifier field. Qualifies the order to a specific action. Move cursor to ORDQ and press ENTER Key. Use DATA ENTRY Keypad (29) to enter desired value for 3 bit word. Press ENTER Key.

64. ESN Format

Numeric base for ESN. Select Dec (decimal), Oct (octal) or Hex (hexadecimal). Move cursor to ESN Format and press ENTER Key. Press DATA SCROLL ↑ Key (3) until desired selection is displayed and press ENTER Key. Select Dec, Oct or Hex numeric base.

65. CADDR

CADDR (Called Address) is the number the Mobile Phone is calling. CADDR may consist of up to 32 characters. Move cursor to CADDR and press ENTER Key. Use DATA ENTRY Keypad (29) to enter desired value and press ENTER Key. Allowable character set is 0-9, # and \*.

66. ESN

ESN (Electronic Serial Number) of the Mobile Phone. Move cursor to ESN and use DATA ENTRY Keypad (29) to enter up to eleven ESN digits. Press ENTER Key. Allowable character set is dependent on the ESN format (see item 64).

67. MIN

MIN (Mobile Identification Number) of the Mobile Phone. Move cursor to MIN and press ENTER Key. Use DATA ENTRY Keypad (29) to enter desired values and press ENTER Key. Allowable character set is 0-9, # and \*.

68. ORDER

Order field. Identifies the order type. Move cursor to ORDER and press ENTER Key. Use DATA ENTRY Keypad (29) to enter desired value and press ENTER Key. Allowable characters are 1 and 0.

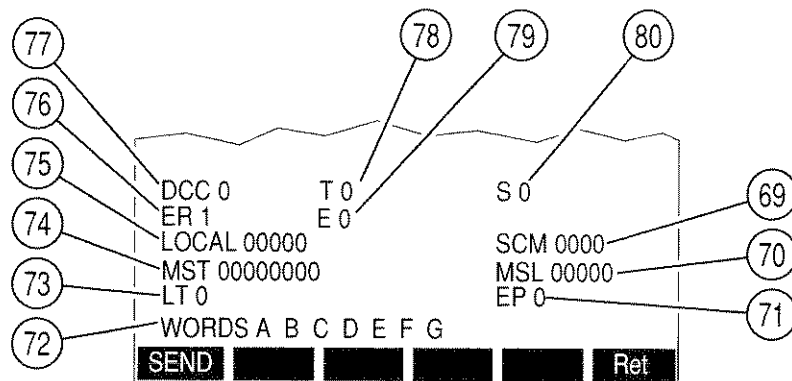

03416140

69. SCM

SCM (Station Class Mark) indicates Power Class, Continuous or Discontinuous Transmission and Bandwidth of the Mobile Phone. SCM is defined in the following table. Move cursor to SCM and press ENTER Key. Use DATA ENTRY Keypad (29) to enter 0 or 1 for each digit of the 4 bit word and press ENTER Key.

POWER CLASS		TRANSMISSION		BANDWIDTH	
Class I	XX00	Continuous	X0XX	20 MHz	0XXX
Class II	XX01	Discontinuous	X1XX	25 MHz	1XXX
Class III	XX10				
Reserved	XX11				

70. MSL

MSL (Message Length or Extended Protocol Message Length). Move cursor to MSL and press ENTER Key. Use DATA ENTRY Keypad (29) to enter 0 or 1 for each digit of the 5 bit word and press ENTER Key.

**NOTE:** MSL is available only when ER (76) is set to 1.

71. EP

When EP (Extended Protocol Capable) is 1, Mobile Phone is capable of Extend Protocol. Move cursor to EP and press ENTER Key to toggle between 1 and 0.

**NOTE:** EP is available only when ER (76) is set to 1.

72. WORDS

Not a selectable field. Indicates the words used in the Reverse Control Channel Message by displaying in red the letter associated with a specific word. Word "A" contains MIN1 ("A" is always red), Word "B" contains MIN2 (see item 79) and Word "C" contains ESN (see item 80). Words "D," "E," "F" and "G" contain the 1st, 2nd, 3rd and 4th eight digit words of the Called Address, respectively (see item 65).

## ITEM

## DESCRIPTION

73. LT

LT (Last Try) identifies whether access attempt is Last Try. Move cursor to LT and press ENTER Key to toggle between 1 and 0.

**NOTE:** LT is available only when ER (76) is set to 1.

74. MST

MST (Extended Protocol Message Type). Move cursor to MST and press ENTER Key. Use DATA ENTRY Keypad (29) to enter 1 or 0 for each digit of the 8 bit word. Press ENTER Key. MST implemented in hexadecimal form as follows:

MESSAGE TYPE	HEX BIT PATTERN
NAMPS Channel Assignment	80
Voice Mail	82
CLI (Call Line Identifier) Order	84
Short Message	85
Short Message Full	83
NAMPS Origination or Page Response	00
Not capable of last extended protocol message	07

75. LOCAL

Used to transmit binary message that is of user-defined value and functionality. Move cursor to LOCAL and press ENTER Key. Use DATA ENTRY Keypad (29) to enter desired value for 5 bit word. Press ENTER Key.

76. ER

ER (Extended Protocol Reverse Channel) indicates if current message is using the Extended Protocol message format. 1 = Extended Protocol; 0 otherwise. Move cursor to ER and press ENTER Key to toggle between 1 and 0.

When ER is 1: MSL (70), EP (71), LT (73) and MST (74) appear.

77. DCC

DCC (Digital Color Code) indicates which Cell Site the Mobile Phone is receiving. Move cursor to DCC and press ENTER Key. Use DATA ENTRY Keypad (29) to enter desired value and press ENTER Key. Range is 0 to 3.

78. T

T (Type of Message) is set to 1 to identify the message as an origination or an order; T is set to 0 to identify the message as an order response or page response. Move cursor to T and press ENTER Key to toggle between 1 and 0.

ITEM

DESCRIPTION

---

79. E

E (Extended Address) is 1 if Mobile Phone must send MIN1 and MIN2; 0 if Mobile Phone must send MIN1, only. Move cursor to E and press ENTER Key to toggle between 1 and 0.

80. S

S (Serial Number) bit is 1 if Mobile Phone must send its Serial Number to access the system; 0 otherwise. Move cursor to S and press ENTER Key to toggle between 1 and 0.

### 7-2-3 FORWARD VOICE CHANNEL CELL SITE SIMULATION SCREEN

#### A. AMPS (WITH NADC FREQUENCIES) FORWARD VOICE CHANNEL SIMULATION

The Forward Voice Channel Simulation Screen simulates a Cell Site by sending Mobile Station Control Messages to the Mobile Phone. To access, press 3 DATA ENTRY Key (29) from the Cellular Simulation Main Menu and press Soft Function Key F1 until "NAMPS" appears (AMPS protocol is selected).

ITEM	DESCRIPTION
------	-------------

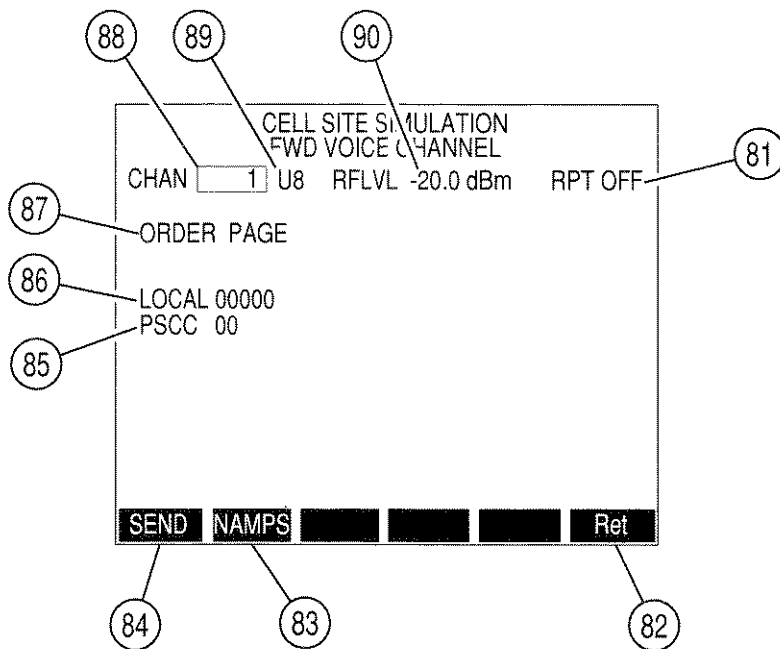

03416141

#### 81. RPT

When RPT (Repeat) is "ON," the message is transmitted continuously when "SEND" Soft Function Key F1 is pressed. Move cursor to RPT and press ENTER Key to toggle between on and off.

**NOTE:** The continuous transmission of the message may be halted by pressing "SEND" Soft Function Key F1, again.

#### 82. "Ret"/"ESC" Soft Function Key F6

"Ret" returns operation to the Cellular Simulation Main Menu. "ESC" appears while parameters are accessed for editing. Allows edit procedure to be canceled leaving parameter unchanged.



## ITEM

## DESCRIPTION

83. "NAMPS"/"NADC" Soft Function Key F2

Transfers operation to Narrow Forward Voice Channel (NAMPS) or Wide Forward Voice Channel (AMPS).

When Soft Function Key F2 is pressed while "NAMPS" is displayed as the Key Function, the operation is transferred to the Narrow Forward Voice Channel. When Soft Function Key F2 is pressed while "NADC" is displayed as the Key Function, the operation is transferred to the Wide Forward Voice Channel. See Figure 7-2.

84. "SEND" Soft Function Key F1

When pressed, the message is sent.

If RPT (Repeat) is off, the message is sent only once. If RPT is on, the message is sent repeatedly until "SEND" is pressed, again.

85. PSCC

PSCC (Present SAT Color Code) displays Color Code received in the last message. Move cursor to PSCC and press ENTER Key. Use DATA ENTRY Keypad (29) to enter desired value for the 2 bit word.

86. LOCAL

Used to transmit binary message that is of user-defined value and functionality. Move cursor to LOCAL and press ENTER Key. Use DATA ENTRY Keypad (29) to enter desired value for 5 bit word. Press ENTER Key.

87. ORDER

Displays the order or message transmitted to the Mobile Phone. The following orders are available: PAGE, SND ADDR, S ALERT, AUDIT, MAINTNC, ALERT, RELEASE, PWR LVL, HANDOFF, NAMPS CH ASGN and EXTENDED PROTOCOL. Move cursor to ORDER and press ENTER Key. Press DATA SCROLL ↑ Key (3) to select desired order or message and press ENTER Key.

88. CHANNEL

Select Channel on which to transmit. See the following table for range of channels. AMPS Channels 313 to 354 are usually Control Channels. AMPS Channels 313 to 333 are System A channels and channels 334 to 354 are System B channels. Move cursor to CHANNEL and press ENTER Key. Use DATA ENTRY Keypad (29) to enter a channel number and press ENTER Key.

NADC BAND	RANGE OF CHANNELS	FREQUENCY BAND
U8 (AMPS)	1 to 1023	800 MHz
U4 (NT400©)	1 to 333	450 MHz
HY (Hyperband)	1 to 1999	1900 MHz

**NOTE:** Items 35, 45, 51, 60, 88 and 110 perform the same function.

ITEM

DESCRIPTION

---

89. NADC Band

Select NADC band. See the preceding table for NADC bands. Move cursor to band indication and press ENTER Key to activate data field. Press DATA SCROLL ↑ Key (3) to select desired band.

**NOTE:** Items 36, 46, 52, 61, 89 and 111 perform the same function.

90. RFLVL

Displays the transmission RF Level. Move cursor to RFLVL and press ENTER Key. Use DATA ENTRY Keypad (29) to enter a desired value and press ENTER Key. Range is -137.0 to 0.0 dBm.

**NOTE:** Items 30, 39, 53, 62, 90, 101, 112 and 113 perform the same function.

## B. NAMPS FORWARD VOICE CHANNEL SIMULATION

The Forward Voice Channel Simulation Screen simulates a Cell Site by sending Mobile Station Control Messages to the Mobile Phone. To access, press 3 DATA ENTRY Key from the Mobile Simulation Main Menu and press Soft Function Key F1 until "NADC" appears (NAMPS protocol is selected).

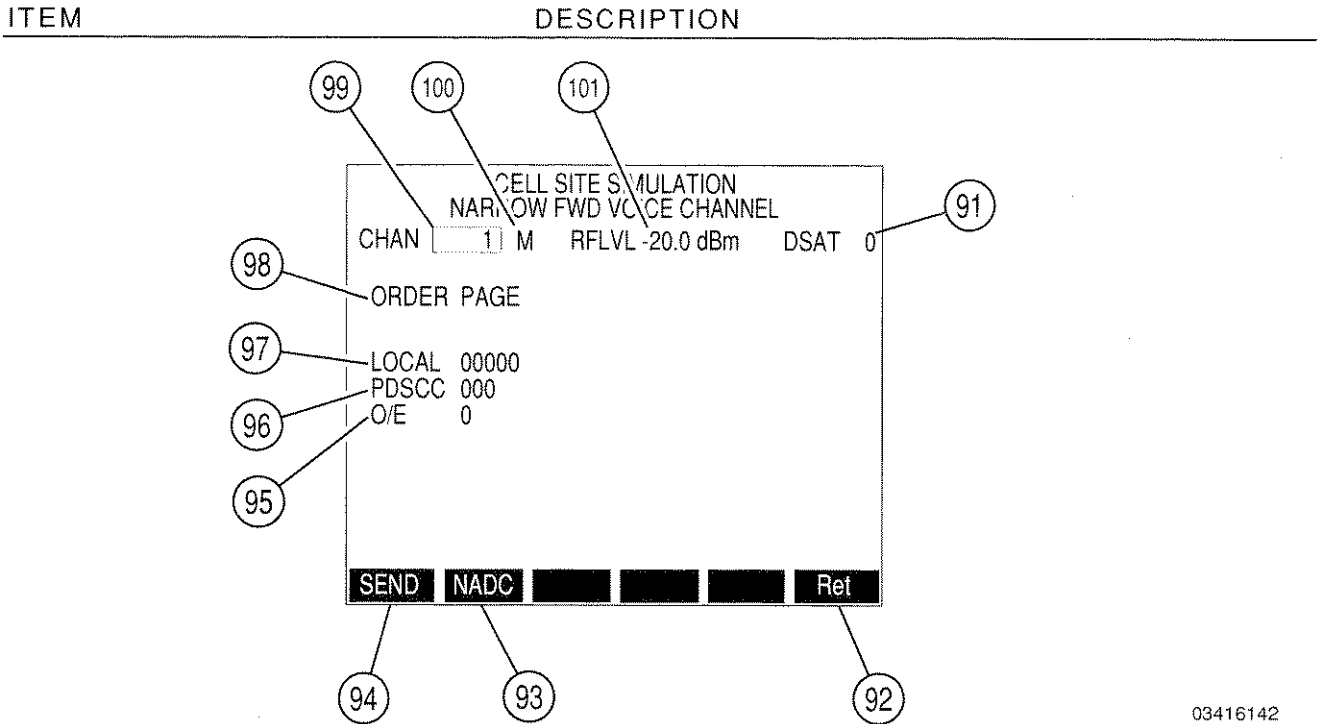

03416142

### 91. DSAT

DSAT (Digital Supervisory Audio Tone) is a digital stream that is one of 7 distinct patterns. DSAT is used on narrow analog channels in place of SAT. The seven valid DSAT sequences are as follows:

DSAT #	SEQUENCE
0	2556CB
1	255B2B
2	256A9B
3	25AD4D
4	26AB2B
5	26B2AD
6	2969AB

Move cursor to DSAT and press ENTER Key. Use DATA ENTRY Keypad (29) to enter desired value and press ENTER Key.

## ITEM

DESCRIPTION

---

92. "Ret"/"ESC" Soft Function Key F6

"Ret" returns operation to the Cellular Simulation Main Menu. "ESC" appears while parameters are accessed for editing. Allows edit procedure to be canceled leaving parameter unchanged.

93. "NADC"/"NAMPS" Soft Function Key F2

Transfers operation to Narrow Forward Voice Channel (NAMPS) or Wide Forward Voice Channel (AMPS).

When Soft Function Key F2 is pressed while "NADC" is displayed as the Key Function, the operation is transferred to the Wide Forward Voice Channel. When Soft Function Key F2 is pressed while "NAMPS" is displayed as the Key Function, the operation is transferred to the Narrow Forward Voice Channel. See Figure 7-2.

94. "SEND" Soft Function Key F1

When pressed, the message is sent.

**NOTE:** The message is repeated only by multiple initiations by the user.

## ITEM

## DESCRIPTION

95. O/E

O/E (Odd/Even) displays the odd/even data field sent in orders and used for adjacent channel protection. O/E is set as follows:

	CHANNEL NUMBER	CENTER ANALOG CHANNEL	O/E
N is odd	$1 \leq N \leq 799$	$N_L$	1
N is even	$1 \leq N \leq 799$	$N_L$	0
N is odd	$991 \leq N \leq 1023$	$N_L$	1
N is even	$991 \leq N \leq 1023$	$N_L$	0
N is odd	$1 \leq N \leq 799$	$N_M$	1
N is even	$1 \leq N \leq 799$	$N_M$	0
N is odd	$991 \leq N \leq 1023$	$N_M$	0
N is even	$991 \leq N \leq 1023$	$N_M$	1
N is odd	$1 \leq N \leq 799$	$N_U$	0
N is even	$1 \leq N \leq 799$	$N_U$	1
N is odd	$991 \leq N \leq 1023$	$N_U$	1
N is even	$991 \leq N \leq 1023$	$N_U$	0

$N_L$ : C12 = 1 and C13 = 0

$N_M$ : C12 = 0 and C13 = 0

$N_U$ : C12 = 0 and C13 = 1

Move cursor to O/E and press ENTER Key to toggle between 1 and 0.

96. PDSCC

PDSCC (Present DSAT Color Code) indicates the DSAT Color Code associated with the present channel. Move cursor to PDSCC and press ENTER Key. Use DATA ENTRY Keypad (29) to enter desire value for 3 bit word. Press ENTER Key.

97. LOCAL

Used to transmit binary message that is of user-defined value and functionality. Move cursor to LOCAL and press ENTER Key. Use DATA ENTRY Keypad (29) to enter desired value for 5 bit word. Press ENTER Key.

## ITEM

## DESCRIPTION

98. ORDER

Displays the message or order to be sent. The following are available: PAGE, SND ADDR (EVEN), SND ADDR (ODD), S ALERT, AUDIT, MAINTNC, ALERT, RELEASE, RELEASE: FADE TIMER, SUSPEND CALLED ADDR, HANDOFF CONFIRMATION, PWR LVL, HANDOFF, MRI and EXTENDED PROTOCOL. Move cursor to ORDER and press ENTER Key. Use DATA SCROLL ↑ Key (3) to select desired order or message and press ENTER Key.

99. CHANNEL

Select Channel set on which to transmit. Range is from 1 to 1023. Channels 313 to 354 are usually Control Channels. Channels 313 to 333 are System A channels and channels 334 to 354 are System B channels. Move cursor to CHANNEL and press ENTER Key. Use DATA ENTRY Keypad (29) to enter a channel and press ENTER Key.

**NOTE:** Items 99 and 123 perform the same function.

100. U/M/L

Selects Upper (10 kHz above channel frequency), Middle (actual channel frequency) or Lower (10 kHz below channel frequency). Move cursor to U and press ENTER Key. Use DATA SCROLL ↑ Key (3) to set U, M or L and press ENTER Key.

**NOTE:** Items 100 and 124 perform the same function.

101. RFLVL

Displays the transmission RF Level. Move cursor to RFLVL and press ENTER Key. Use DATA ENTRY Keypad (29) to enter a desired value and press ENTER Key. Range is -137.0 to 0.0 dBm.

**NOTE:** Items 30, 39, 53, 62, 90, 101, 112 and 113 perform the same function.

## 7-2-4 REVERSE VOICE CHANNEL MOBILE SIMULATION SCREEN

### A. AMPS (with NADC Frequencies) Reverse Voice Channel Simulation

The Reverse Voice Channel Simulation Screen simulates a Mobile Phone by generating a Audit, Power Level, Send Called Address or a Serial Number Request order. To access, press 4 DATA ENTRY Key (29) from the Cellular Simulation Main Menu and press Soft Function Key F1 until "NAMPS" appears (AMPS protocol is selected).

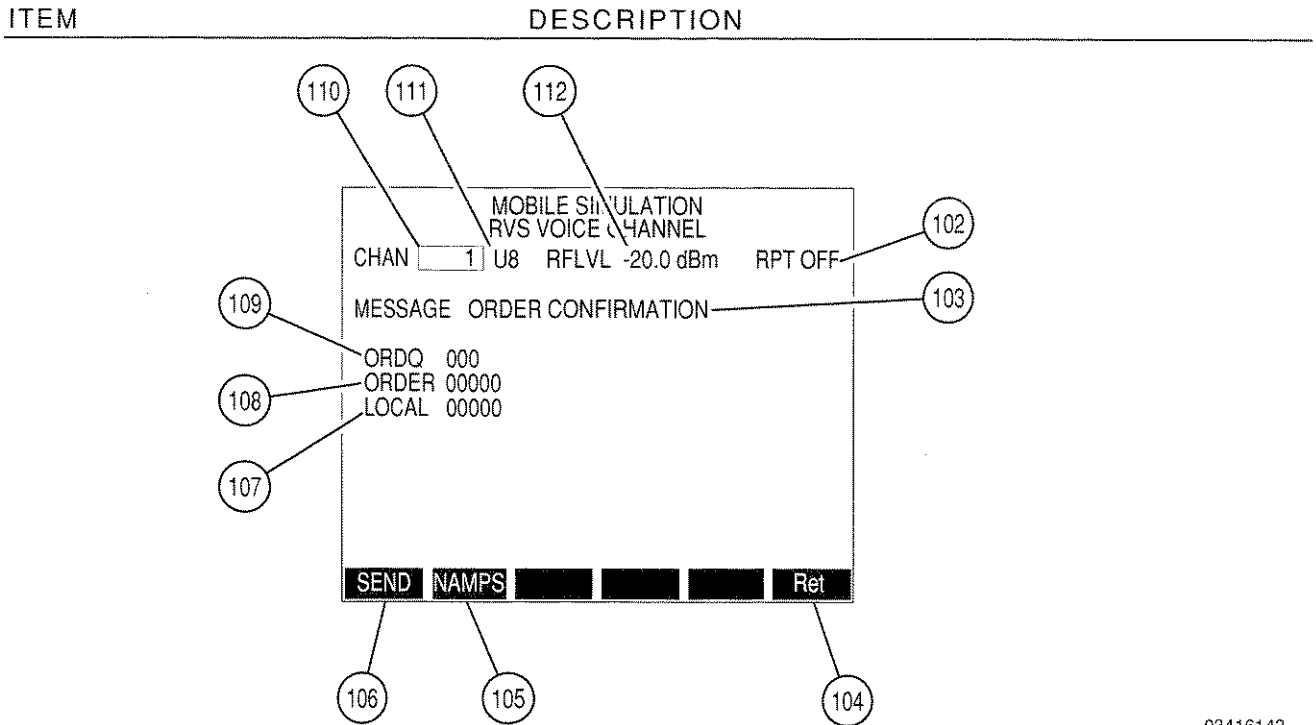

03416143

#### 102. RPT

When RPT (Repeat) is "ON," the message is transmitted continuously when "SEND" Soft Function Key F1 is pressed. Move cursor to RPT and press ENTER Key to toggle between on and off.

**NOTE:** The continuous transmission of the message may be halted by pressing "SEND" Soft Function Key F1, again.

#### 103. MESSAGE

Displays the type of message to be transmitted. Messages that are available are: ORDER CONFIRMATION, CALLED ADDRESS and EXTENDED PROTOCOL. Move cursor to MESSAGE and press ENTER Key. Use DATA SCROLL ↑ Key (3) to select desired message and press ENTER KEY.

#### 104. "Ret"/"ESC" Soft Function Key F6

"Ret" returns operation to the Cellular Simulation Main Menu. "ESC" appears while parameters are accessed for editing. Allows edit procedure to be canceled without changing parameter.

## ITEM

## DESCRIPTION

105. "NAMPS"/"NADC" Soft Function Key F2

Transfers operation to Narrow Reverse Voice Channel (NAMPS) or Wide Reverse Voice Channel (AMPS).

When Soft Function Key F2 is pressed while "NAMPS" is displayed as the Key Function, the operation is transferred to the Narrow Reverse Voice Channel. When Soft Function Key F2 is pressed while "NADC" is displayed as the Key Function, the operation is transferred to the Wide Reverse Voice Channel. See Figure 7-2.

106. "SEND" Soft Function Key F1

When pressed, the message is sent.

If RPT (Repeat) is off, the message is sent only once. If RPT is on, the message is sent repeatedly until "SEND" is pressed, again.

107. LOCAL

LOCAL is used to transmit binary message that is of user-defined value and functionality. Move cursor to LOCAL and press ENTER Key. Use DATA ENTRY Keypad (29) to enter desired value for 5 bit word. Press ENTER Key.

108. ORDER

Identifies the order type. Move cursor to ORDER and press ENTER Key. Use DATA ENTRY Keypad (29) to enter desired value for 5 bit word. Press ENTER Key.

109. ORDQ

ORDQ (Order Qualifier) qualifies the order confirmation to a specific action. Move cursor to ORDQ and press ENTER Key. Use DATA ENTRY Keypad (29) to enter desired value for 3 bit word. Press ENTER Key.

110. CHANNEL

Select Channel on which to transmit. See the following table for range of channels. AMPS Channels 313 to 354 are usually Control Channels. AMPS Channels 313 to 333 are System A channels and channels 334 to 354 are System B channels. Move cursor to CHANNEL and press ENTER Key. Use DATA ENTRY Keypad (29) to enter a channel number and press ENTER Key.

NADC BAND	RANGE OF CHANNELS	FREQUENCY BAND
U8 (AMPS)	1 to 1023	800 MHz
U4 (NT400©)	1 to 333	450 MHz
HY (Hyperband)	1 to 1999	1900 MHz

**NOTE:** Items 35, 45, 51, 60, 88 and 110 perform the same function.



ITEM	DESCRIPTION
111. <u>NADC Band</u>	<p>Select NADC band. See the preceding table for NADC bands. Move cursor to band indication and press ENTER Key to activate data field. Press DATA SCROLL ↑ Key (3) to select desired band.</p> <p><b>NOTE:</b> Items 36, 46, 52, 61, 89 and 111 perform the same function.</p>
112. <u>RFLVL</u>	<p>Displays the transmission RF Level. Move cursor to RFLVL and press ENTER Key. Use DATA ENTRY Keypad (29) to enter a desired value and press ENTER Key. Range is -137.0 to 0.0 dBm.</p> <p><b>NOTE:</b> Items 30, 39, 53, 62, 90, 101, 112 and 113 perform the same function.</p>

## B. NAMPS REVERSE VOICE CHANNEL SIMULATION

The Reverse Voice Channel Simulation Screen simulates a Mobile Phone by generating an Audit, Power Level, Send Called Address or a Serial Number Request order. To access, press 4 DATA ENTRY Key from the Mobile Simulation Main Menu and press Soft Function Key F1 until "NADC" appears (NAMPS protocol is selected).

ITEM	DESCRIPTION
113	RFLVL
114	"Ret"/"ESC" Soft Function Key F6
115	"NADC"/"NAMPS" Soft Function Key F3
116	SEND
117	BER 0000000
118	RSSI 000
119	VMAC 000
120	MESSAGE MRI
121	DST/DSAT 0
122	CHAN 1 M
123	MOBILE SIMULATION
124	NARROW RVS VOICE CHANNEL

The screenshot shows a terminal-style interface for 'MOBILE SIMULATION NARROW RVS VOICE CHANNEL'. The screen displays several parameters: 'RFLVL - 20.0 dBm', 'CHAN 1 M', 'DST/DSAT 0', 'MESSAGE MRI', 'O/E 0', 'VMAC 000', 'RSSI 000', and 'BER 0000000'. At the bottom, there are four buttons: 'SEND', 'NADC', a blank button, and 'Ret'. Callout numbers 113 through 124 are placed around the screen, with lines pointing to these specific elements: 113 points to RFLVL, 114 to Ret, 115 to NADC, 116 to SEND, 117 to BER, 118 to RSSI, 119 to VMAC, 120 to MESSAGE MRI, 121 to DST/DSAT, 122 to CHAN, 123 to MOBILE SIMULATION, and 124 to NARROW RVS VOICE CHANNEL.

03416144

### 113. RFLVL

Displays the transmission RF Level. Move cursor to RFLVL and press ENTER Key. Use DATA ENTRY Keypad (29) to enter a desired value and press ENTER Key. Range is -137.0 to 0.0 dBm.

**NOTE:** Items 30, 39, 53, 62, 90, 101, 112 and 113 perform the same function.

### 114. "Ret"/"ESC" Soft Function Key F6

"Ret" returns operation to the Cellular Simulation Main Menu. "ESC" appears while parameters are accessed for editing. Allows edit procedure to be canceled leaving parameter unchanged.

### 115. "NADC"/"NAMPS" Soft Function Key F3

Transfers operation to Narrow Reverse Voice Channel (NAMPS) or Wide Reverse Voice Channel (AMPS).

When Soft Function Key F2 is pressed while "NADC" is displayed as the Key Function, the operation is transferred to the Wide Reverse Voice Channel. When Soft Function Key F2 is pressed while "NAMPS" is displayed as the Key Function, the operation is transferred to the Narrow Reverse Voice Channel. See Figure 7-2.

## ITEM

## DESCRIPTION

116. "SEND" Soft Function Key F5

When pressed, the message is sent.

**NOTE:** The message is repeated only by multiple initiations by the user.

117. BER

BER (Bit Error Rate) displays the number of bit errors over the last reporting period. Move cursor to BER and press ENTER Key. Use DATA ENTRY Keypad (29) to enter desired value for 7 bit word. Press ENTER Key.

118. RSSI

RSSI (Received Signal Strength) displays received signal strength over the last reporting period. Move cursor to RSSI and press ENTER Key. Use DATA ENTRY Keypad (29) to enter desired value and press ENTER Key. The 3 bit word values and related Received Signal Strength values are as shown below:

RECEIVED SIGNAL STRENGTH ( $\pm 5$ dBm)	CODED VALUE
Land Station Immediate Response Request	000
-75 dBm	001
-80 dBm	010
-85 dBm	011
-90 dBm	100
-95 dBm	101
-100 dBm	110
-105 dBm	111

119. VMAC

VMAC (Voice Mobile Attenuation Code) displays the current mobile station power attenuation. Move cursor to VMAC and press ENTER Key. Use DATA ENTRY Keypad (29) to enter desired value for 3 bit word. Press ENTER Key.

120. O/E

O/E (Odd/Even). Move cursor to O/E and press ENTER Key to toggle between 1 and 0.

121. MESSAGE

Displays the type of message to be transmitted over the Reverse Voice Channel. Messages available are as follows: MRI, ORDER/ORDER CONFIRMATION and FLASH/CALLED ADDRESS. Move cursor to MESSAGE and press ENTER Key. Use DATA SCROLL  $\uparrow$  Key (3) to select desired message and press ENTER Key.

## ITEM

DESCRIPTION

---

122. DSAT/DST

Selects the seven valid DSAT sequences 0 through 6. Move cursor to DSAT/DST and press ENTER Key. Use DATA ENTRY Keypad (29) to enter desired value and press ENTER Key.

123. CHANNEL

Select Channel set on which to transmit. Range is from 1 to 1023. Channels 313 to 354 are usually Control Channels. Channels 313 to 333 are System A channels and channels 334 to 354 are System B channels. Move cursor to CHANNEL and press ENTER Key. Use DATA ENTRY Keypad (29) to enter a channel and press ENTER Key.

**NOTE:** Items 99 and 123 perform the same function.

124. U/M/L

Selects Upper (10 kHz above channel frequency), Middle (actual channel frequency) or Lower (10 kHz below channel frequency). Move cursor to U and press ENTER Key. Use DATA SCROLL ↑ Key (3) to set U, M or L and press ENTER Key.

**NOTE:** Items 100 and 124 perform the same function.

## 7-2-5 CELLULAR SIMULATION SETTINGS

The Cellular Simulation Settings Screen is accessed by pressing 5 DATA ENTRY Key (29) from the Cellular Simulation Main Menu.

MENU ITEM	DESCRIPTION
-----------	-------------

CELLULAR SIMULATION	
Make Selection:	
1. Forward Control Channel	
2. Reverse Control Channel	
3. Reverse Voice Channel	
4. Cellular Settings	
1. AMPS Deviation	8.0 kHz
2. SAT Deviation	2.0 kHz
3. SAT Frequency	5970
4. NAMPS Deviation	0.7 kHz
5. Continuous Delay	0.10 Sec
6. Channel Band	NADC-U8
Ret ESC	

03416145

**NOTE:** "ESC" appears while parameters are accessed for editing. Allows edit procedure to be canceled without changing parameter and closes the Cellular Simulation Settings Screen.

Pressing "Ret" Soft Function Key F5 at any point during the operation of the following menu items (except in the SAT Frequency submenu), returns operation to the RF Generator Screen.

### 1. AMPS Deviation

Sets the modulation level for data and SAT Tone. Press 1 DATA ENTRY Key (29) to activate data field. Use DATA ENTRY Keypad (29) to enter desired value and press ENTER Key. Range is 0.0 to 25.0 kHz

### 2. SAT Deviation

Sets the modulation level for the SAT tone. Press 2 DATA ENTRY Key (29) to activate data field. Use DATA ENTRY Keypad (29) to enter desired value and press ENTER Key. Range is 0.0 to 25.0 kHz

MENU ITEM

DESCRIPTION

3. SAT Frequency

Sets the frequency of the SAT tone. Press 3 DATA ENTRY Key (29) to display SAT Frequency submenu shown below. Use DATA SCROLL ↑ Key (3) to select desired SAT Frequency and press ENTER Key.

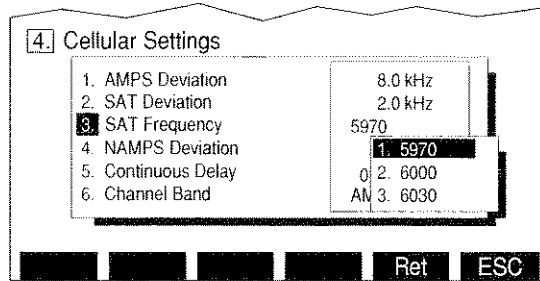

03416158

4. NAMPS Deviation

Sets the modulation level for NAMPS data, DSAT and DST. Press 4 DATA ENTRY Key (29) to activate data field. Use DATA ENTRY Keypad (29) to enter desired value and press ENTER Key. Range is 0.0 to 25.0 kHz

5. Continuous Delay

Sets the delay interval between messages when in the continuous mode. Press 5 DATA ENTRY Key (29) to activate data field. Use DATA ENTRY Keypad (29) to enter desired value and press ENTER Key. Range is 0.00 to 99.00 seconds.

6. Channel Band

Selects the cellular band: NADC-U8 (800 MHz - AMPS), NADC-U4 (450 MHz - NT400©) or NADC-HY (1900 MHz - Hyperband). Press ENTER Key to select desired band.

### 7-3 AMPS/NAMPS REMOTE OPERATION

The AMPS/NAMPS Cell Site Monitor and Simulation can be remotely operated similar to other Operation Modes of the IFR-1900. To perform the setup for Remote Operation, see Section 6. The Cellular TMAC Commands are listed in Table 7-1.

The Forward Control Channel Screen must be displayed when executing most of the CELL commands. A command for displaying the Forward Control Channel Screen, :SCREEN:CELL, is included in the table of commands. Most of the Cellular Commands are time dependent and hold the last decoded information. Once the command has been read, the information may not be available until decoded from another stream sequence. Recording the readings prevents the loss of information.

Table 7-1 lists the Cellular Remote Operation Commands. The Command short (abbreviated) form is shown in upper case while the remainder of the long form is shown in lower case. These commands are complete except where the user must determine a parameter shown by x. The parameter value or value range is listed where applicable.

COMMAND	RANGE/VALUE	DESCRIPTION
:SCREEN:CELL		Displays Cell Site Monitor Forward Control Channel Screen.
:SCREEN:GENCELLular		Displays Cellular Simulation Main Menu.
:SCREEN:GENFOCC		Displays Cell Site Simulation Forward Control Channel Screen.
:SCREEN:GENRECC		Displays Mobile Simulation Reverse Control Channel Screen.
:SCREEN:GENFVC		Displays Cell Site Simulation Forward Voice Channel Screen.
:SCREEN:GENRVC		Displays Mobile Simulation Reverse Voice Channel Screen.
<b>AMPS/NAMPS CELL SITE MONITOR COMMANDS</b>		
:CELL:WORDA		Selects decoding of Stream A words.
:CELL:WORDB		Selects decoding of Stream B words.
:CELL:BOTH		Selects decoding of both Stream A and B words.
:CELL:WORD?		Returns current decoding selection: WORDA, WORDB or BOTH.

Table 7-1 IFR-1900 Specific Cellular Commands

COMMAND	RANGE/VALUE	DESCRIPTION
:CELL:CHANnel x	1 to 1023	Specifies Channel.
:CELL:CHANnel?		Returns current Channel.
:CELL:B_I?		Returns current setting of Busy/Idle bit or -1 if not available.
:CELL:DCC?		Returns current DCC value or -1 if not available.
:CELL:SCC?		Returns current SCC value or -1 if not available.
:CELL:SID?		Returns current SID value or -1 if not available.
:CELL:MIN?		Returns current MIN value or -1 if not available. Returning format is: "xxx/xxx-xxxx."
:CELL:ORDER?		Returns current ORDER value or -1 if not available.
:CELL:VMAC?		Returns current VMAC value or -1 if not available.
:CELL:VCHAN?		Returns current Voice Channel number or -1 if not available.
:CELL:CMAx_1?		Returns current CMAx-1 value or -1 if not available.
:CELL:N_1?		Returns current N-1 value or -1 if not available.
:CELL:CMAC?		Returns current CMAC value or -1 if not available.
:CELL:END?		Returns current setting of END bit or -1 if not available.
:CELL:WFOM?		Returns current setting of WFOM bit or -1 if not available.
:CELL:ACTion?		Returns current Action field value or -1 if not available.
:CELL:NAWC?		Returns current NAWC value or -1 if not available.
:CELL:S?		Returns current setting of S bit or -1 if not available.
:CELL:E?		Returns current setting of E bit or -1 if not available.

Table 7-1 IFR-1900 Specific Cellular Commands (cont)



COMMAND	RANGE/VALUE	DESCRIPTION
:CELL:REGH?		Returns current setting of REGH bit or -1 if not available.
:CELL:REGR?		Returns current setting of REGR bit or -1 if not available.
:CELL:DTX?		Returns current setting of DTX bit or -1 if not available.
:CELL:RCF?		Returns current setting of RCF bit value or -1 if not available.
:CELL:CPA?		Returns current setting of CPA bit or -1 if not available.
:CELL:OLC?		Returns current OLC value or -1 if not available.
:CELL:BIS?		Returns current setting of BIS bit or -1 if not available.
:CELL:REGINCR?		Returns current REGINCR value or -1 if not available.
:CELL:CHANPOS1?		Returns current value of first channel position field from the directed retry message or -1 if not available.
:CELL:CHANPOS2?		Returns current value of the second channel position field from the directed retry message or -1 if not available.
:CELL:CHANPOS3?		Returns current value of the third channel position field from the directed retry message or -1 if not available.
:CELL:CHANPOS4?		Returns current value of the fourth channel position field from the directed retry message or -1 if not available.
:CELL:CHANPOS5?		Returns current value of the fifth channel position field from the directed retry message or -1 if not available.
:CELL:CHANPOS6?		Returns current value of the sixth channel position field from the directed retry message or -1 if not available.

Table 7-1 IFR-1900 Specific Cellular Commands (cont)

COMMAND	RANGE/VALUE	DESCRIPTION
:CELL:NEWACC?		Returns current NEWACC value or -1 if not available.
:CELL:MAXbusy:PGR?		Returns current value of Maximum Busy for page response or -1 if not available.
:CELL:MAXbusy:OTHer?		Returns current value of Maximum Busy for Other accesses or -1 if not available.
:CELL:MAXSztr:PGR?		Returns current value of Maximum Seizure Tries for page response or -1 if not available.
:CELL:MAXSztr:OTHer?		Returns current value of Maximum Seizure Tries for Other accesses or -1 if not available.
:CELL:PSCC?		Returns current PSCC value or -1 if not available.
:CELL:ESN?		Returns current ESN value or -1 if not available.
:CELL:DIGITs?		Returns current Call address value or -1 if not available.
:CELL:PDSCC?		Returns current PDSCC value or -1 if not available.
:CELL:EP?		Returns current EP value or -1 if not available.
:CELL:EF?		Returns current EF value or -1 if not available.
:CELL:DSCC?		Returns current DSCC value or -1 if not available.
:CELL:LOCALCTRL1?		Returns current first position field for the Local Control value or -1 if not available.
:CELL:LOCALCTRL2?		Returns current second position field for the Local Control value or -1 if not available.

Table 7-1 IFR-1900 Specific Cellular Commands (cont)

COMMAND	RANGE/VALUE	DESCRIPTION
:CELL:C12?		Returns current C12 value or -1 if not available.
:CELL:C13?		Returns current C13 value or -1 if not available.
:CELL:MST?		Returns current MST value or -1 if not available.
:CELL:MSL?		Returns current MSL value or -1 if not available.
:CELL:FORMat:x	AMPS, NT400, PCS	Specifies NADC band.
:CELL:FORMat?		Returns NADC band.
:CELL:FORMat:NADC:x	U8, U4, HY	Specifies NADC band.
:CELL:FORMat:NAMPS:BAND:x	Lower, Middle, Upper	Specifies NAMPS band.
:CELL:FORMat:BAND?	Returns one of the following: AMPS, NT400, PCS, L, M, U	Returns NADC or NAMPS band.
:CELL:CAPTure:MODE:x	MIN, ORDer, BOTH, OFF	Specifies Mode on which to Capture: MIN, ORDER, BOTH (MIN and ORDER) or OFF (none).
:CELL:CAPTure:MODE?		Returns current capture mode: MIN, ORDER, BOTH or OFF
:CELL:CAPTure:MIN "string"	0-9, # and * separated by / (slash) and - (dash) using the format: "xxx/xxx-xxxx"	Specifies MIN capture value.
:CELL:CAPTure:MIN?		Returns current MIN Capture value in the format: "xxx/xxx-xxxx."

Table 7-1 IFR-1900 Specific Cellular Commands (cont)

COMMAND	RANGE/VALUE	DESCRIPTION
:CELL:CAPture:ORDer:x	PAGE, ALERT, RELease, REORDer, SALERT, AUDIT, SNDAAddr, INTERCEPT, MAINTenance, POWer, DRETRY, AUTREG, AINTERCEPT, AREORDer, AALERT, VCDES	Specifies Order on which to capture.
:CELL:CAPture:ORDer?		Returns current Order on which to capture.
<b>AMPS/NAMPS CELLULAR SIMULATION COMMANDS</b>		
<b>FORWARD CONTROL CHANNEL</b>		
:CELL:GEN:FOCC:CHANnel x	1 to 1023	Specifies Channel.
:CELL:GEN:FOCC:CHANnel?		Returns current Channel.
:CELL:GEN:FOCC:CMAC x	0 to 7	Specifies value of Control Mobile Attenuation Code in the Control-Filler Message.
:CELL:GEN:FOCC:CMAC?		Returns current value of Control Mobile Attenuation Code in the Control-Filler Message.
:CELL:GEN:FOCC:CMAX x	1 to 128	Specifies value of Maximum number of channels in System Parameter Overhead Message.
:CELL:GEN:FOCC:CMAX?		Returns current value of Maximum number of channels in System Parameter Overhead Message.
:CELL:GEN:FOCC:CPA x	0 or 1	Sets Combined Paging/Access bit in System Parameter Overhead Message.
:CELL:GEN:FOCC:CPA?		Returns current setting of Combined Paging/Access bit in System Parameter Overhead Message.

Table 7-1 IFR-1900 Specific Cellular Commands (cont)

COMMAND	RANGE/VALUE	DESCRIPTION
:CELL:GEN:FOCC:DCC x	0 to 3	Specifies value of Digital Color Code in System Parameter Overhead Message.
:CELL:GEN:FOCC:DCC?		Returns current value of Digital Color Code in System Parameter Overhead Message.
:CELL:GEN:FOCC:DTX x	0 to 3	Specifies value of Discontinuous Transmission in System Parameter Overhead Message.
:CELL:GEN:FOCC:DTX?		Returns current value of Discontinuous Transmission in System Parameter Overhead Message.
:CELL:GEN:FOCC:E x	0 or 1	Sets Extended Address bit in System Parameter Overhead Message.
:CELL:GEN:FOCC:E?		Returns current setting of Extended Address bit in System Parameter Overhead Message.
:CELL:GEN:FOCC:EP x	0 or 1	Sets Extended Protocol bit in System Parameter Overhead Message.
:CELL:GEN:FOCC:EP?		Returns current setting of Extended Protocol bit in System Parameter Overhead Message.
:CELL:GEN:FOCC:N x	1 to 32	Specifies value of Number of paging channels in System Parameter Overhead Message.
:CELL:GEN:FOCC:N?		Returns current value of Number of paging channels in System Parameter Overhead Message.

Table 7-1 IFR-1900 Specific Cellular Commands (cont)

COMMAND	RANGE/VALUE	DESCRIPTION
:CELL:GEN:FOCC:RCF x	0 or 1	Sets Read Control Filler bit in System Parameter Overhead Message.
:CELL:GEN:FOCC:RCF?		Returns current setting of Read Control Filler bit in System Parameter Overhead Message.
:CELL:GEN:FOCC:REGH x	0 or 1	Sets Registration for Home Stations bit in System Parameter Overhead Message.
:CELL:GEN:FOCC:REGH?		Returns current setting of Registration for Home Stations bit in System Parameter Overhead Message.
:CELL:GEN:FOCC:REGR x	0 or 1	Sets Registration for Roaming Mobile Phones bit in System Parameter Overhead Message.
:CELL:GEN:FOCC:REGR?		Returns current setting of Registration for Roaming Mobile Phones bit in System Parameter Overhead Message.
:CELL:GEN:FOCC:S x	0 or 1	Sets Serial Number bit in System Parameter Overhead Message.
:CELL:GEN:FOCC:S?		Returns current setting of Serial Number bit in System Parameter Overhead Message.
:CELL:GEN:FOCC:SID x	0 to 32767	Specifies value of System Identification number in System Parameter Overhead Message.
:CELL:GEN:FOCC:SID?		Returns current value of System Identification number in System Parameter Overhead Message.

Table 7-1 IFR-1900 Specific Cellular Commands (cont)

COMMAND	RANGE/VALUE	DESCRIPTION
:CELL:GEN:FOCC:SEND		Begin transmitting the System Parameter Overhead Message
:CELL:GEN:FOCC:SETUP		Configures the IFR-1900 for the Forward Control Channel Screen without going to the screen.
:CELL:GEN:FOCC:STOP		Stops transmitting the System Parameter Overhead Message
:CELL:GEN:FOCC:WFOM x	0 or 1	Sets Wait for Overhead Message bit in the Control-Filler Message.
:CELL:GEN:FOCC:WFOM?		Returns current setting of Wait for Overhead Message bit in the Control-Filler Message.
:CELL:GEN:GLACT:ACTion:RESCAN x	0 or 1	Turns on or off Rescan in the Global Action Overhead Message menu.
:CELL:GEN:GLACT:ACTion:RESCAN?		Returns current setting of Rescan in the Global Action Overhead Message menu.
:CELL:GEN:GLACT:ACTion:REGINCR x	0 or 1	Turns on (1) or off (0) Registration Increment in the Global Action Overhead Message menu.
:CELL:GEN:GLACT:ACTion:REGINCR?		Returns current setting of Registration Increment in the Global Action Overhead Message menu.
:CELL:GEN:GLACT:ACTion:NEWACC x	0 or 1	Turns on (1) or off (0) New Access channel set in the Global Action Overhead Message menu.
:CELL:GEN:GLACT:ACTion:NEWACC?		Returns current setting of New Access channel set in the Global Action Overhead Message menu.

Table 7-1 IFR-1900 Specific Cellular Commands (cont)

COMMAND	RANGE/VALUE	DESCRIPTION
:CELL:GEN:GLACT:ACTion:OLC x	0 or 1	Turns on (1) or off (0) Overload Control in the Global Action Overhead Message menu.
:CELL:GEN:GLACT:ACTion:OLC?		Returns current setting of Overload Control in the Global Action Overhead Message menu.
:CELL:GEN:GLACT:ACTion:BIS x	0 or 1	Turns on (1) or off (0) Access Type in the Global Action Overhead Message menu.
:CELL:GEN:GLACT:ACTion:BIS?		Returns current setting of Access Type in the Global Action Overhead Message menu.
:CELL:GEN:GLACT:ACTion:ACCess x	0 or 1	Turns on (1) or off (0) Access Attempt in the Global Action Overhead Message menu.
:CELL:GEN:GLACT:ACTion:ACCess?		Returns current setting of Access Attempt in the Global Action Overhead Message menu.
:CELL:GEN:GLACT:ACTion:LOCAL1 x	0 or 1	Turns on (1) or off (0) Local Control 1 in the Global Action Overhead Message menu.
:CELL:GEN:GLACT:ACTion:LOCAL1?		Returns current setting of Local Control 1 in the Global Action Overhead Message menu.
:CELL:GEN:GLACT:ACTion:LOCAL2 x	0 or 1	Turns on (1) or off (0) Local Control 2 in the Global Action Overhead Message menu.
:CELL:GEN:GLACT:ACTion:LOCAL2?		Returns current setting of Local Control 2 in the Global Action Overhead Message menu.
:CELL:GEN:GLACT:BIS x	0 or 1	Sets Busy-Idle Status bit in the Global Action Overhead Message.
:CELL:GEN:GLACT:BIS?		Returns current setting of Busy-Idle Status bit in the Global Action Overhead Message.

Table 7-1 IFR-1900 Specific Cellular Commands (cont)



COMMAND	RANGE/VALUE	DESCRIPTION
:CELL:GEN:GLACT:CHANNEL x	1 to 1023	Specifies Channel.
:CELL:GEN:GLACT:CHANNEL?		Returns current Channel.
:CELL:GEN:GLACT:LOCALcntl x	0 to 65535	Specifies value of Local Control in the Global Action Overhead Message.
:CELL:GEN:GLACT:LOCALcntl?		Returns current value of Local Control in the Global Action Overhead Message.
:CELL:GEN:GLACT:MAXBusy:OTHer x	0 to 15	Specifies value of Maximum number of Busy occurrences allowed for Other accesses in the Global Action Overhead Message.
:CELL:GEN:GLACT:MAXBusy:OTHer?		Returns current value of Maximum number of Busy occurrences allowed for Other accesses in the Global Action Overhead Message.
:CELL:GEN:GLACT:MAXBusy:PGR x	0 to 15	Specifies value of Maximum number of Busy occurrences allowed for Page Responses in the Global Action Overhead Message.
:CELL:GEN:GLACT:MAXBusy:PGR?		Returns current value of Maximum number of Busy occurrences allowed for Page Responses in the Global Action Overhead Message.
:CELL:GEN:GLACT:MAXSztr:OTHer x	0 to 15	Specifies value of Maximum number of Seizure attempts allowed for Other accesses in the Global Action Overhead Message.
:CELL:GEN:GLACT:MAXSztr:OTHer?		Returns current value of Maximum number of Seizure attempts allowed for Other accesses in the Global Action Overhead Message.

Table 7-1 IFR-1900 Specific Cellular Commands (cont)

COMMAND	RANGE/VALUE	DESCRIPTION
:CELL:GEN:GLACT:MAXSztr:PGR x	0 to 15	Specifies value of Maximum number of Seizure attempts allowed for Page Responses in the Global Action Overhead Message.
:CELL:GEN:GLACT:MAXSztr:PGR?		Returns current value of Maximum number of Seizure attempts allowed for Page Responses in the Global Action Overhead Message.
:CELL:GEN:GLACT:NEWACC x	0 to 2047	Specifies value of New Access Channel starting point in the Global Action Overhead Message.
:CELL:GEN:GLACT:NEWACC?		Returns current value of New Access Channel starting point in the Global Action Overhead Message.
:CELL:GEN:GLACT:OLC x	0 to 32767	Specifies value of Overload Control Class in the Global Action Overhead Message.
:CELL:GEN:GLACT:OLC?		Returns current value of Overload Control Class in the Global Action Overhead Message.
:CELL:GEN:GLACT:REPEAT:x	ON or OFF	Turns Repeat on or off for the Global Action Overhead Message.
:CELL:GEN:GLACT:REPEAT?		Returns current setting of Repeat for the Global Action Overhead Message.
:CELL:GEN:GLACT:REGINCR x	0 to 4095	Specifies value of Registration Increment in the Global Action Overhead Message.
:CELL:GEN:GLACT:REGINCR?		Returns current value of Registration Increment in the Global Action Overhead Message.

Table 7-1 IFR-1900 Specific Cellular Commands (cont)

COMMAND	RANGE/VALUE	DESCRIPTION
:CELL:GEN:GLACT:SEND		Appends the Global Action Overhead Message to the System Parameter Overhead Message.
:CELL:GEN:GLACT:SETUP		Configures the IFR-1900 for the Global Action Overhead Message Screen without going to the screen.
:CELL:GEN:GLACT:STOP		Stops the Global Action Overhead Message from being sent with the System Parameter Overhead Message.
:CELL:GEN:MSCM:C12 x	0 or 1	Sets C12 bit in the Mobile Station Control Message.
:CELL:GEN:MSCM:C12?		Returns current setting of C12 bit in the Mobile Station Control Message.
:CELL:GEN:MSCM:C13 x	0 or 1	Sets C13 bit in the Mobile Station Control Message.
:CELL:GEN:MSCM:C13?		Returns current setting of C13 bit in the Mobile Station Control Message.
:CELL:GEN:MSCM:CHAN x	1 to 2047	Specifies voice channel to which call is assigned in the Mobile Station Control Message.
:CELL:GEN:MSCM:CHAN?		Returns current voice channel assignment for call in the Mobile Station Control Message.
:CELL:GEN:MSCM:CHANNEL x	1 to 1023	Specifies Channel.
:CELL:GEN:MSCM:CHANNEL?		Returns current Channel.
:CELL:GEN:MSCM:CHANPos x,y	1 to 6, 0 to 127	Sets the position of a control channel relative to the first access channel in the Mobile Station Control Message.
:CELL:GEN:MSCM:CHANPos? x	1 to 6	Returns the current position of a control channel relative to the first access channel in the Mobile Station Control Message.

Table 7-1 IFR-1900 Specific Cellular Commands (cont)

COMMAND	RANGE/VALUE	DESCRIPTION
:CELL:GEN:MSCM:CLI " <i>string</i> "	0-9, #, * and N (Null). 32 characters, maximum.	Specifies Call Line Identifier string in the Mobile Station Control Message.
:CELL:GEN:MSCM:CLI?		Returns current Call Line Identifier string in the Mobile Station Control Message.
:CELL:GEN:MSCM:DSCC x	0 to 7	Specifies value of DSAT Color Code in the Mobile Station Control Message.
:CELL:GEN:MSCM:DSCC?		Returns current value of DSAT Color Code in the Mobile Station Control Message.
:CELL:GEN:MSCM:EF x	0 or 1	Sets Extended Protocol Forward Channel Indicator bit in the Mobile Station Control Message.
:CELL:GEN:MSCM:EF?		Returns current setting of Extended Protocol Forward Channel Indicator bit in the Mobile Station Control Message.
:CELL:GEN:MSCM:LOCAL x	0 to 31	Specifies value of LOCAL in the Mobile Station Control Message.
:CELL:GEN:MSCM:LOCAL?		Returns current value of LOCAL in the Mobile Station Control Message.
:CELL:GEN:MSCM:MIN " <i>string</i> "	0-9, # and * separated by / (slash) and - (dash) using the format: " <i>xxx/xxx-xxxx</i> "	Specifies Mobile Identification Number in the Mobile Station Control Message.
:CELL:GEN:MSCM:MIN?		Returns current Mobile Identification Number in the Mobile Station Control Message.
:CELL:GEN:MSCM:MSL x	0 to 31	Specifies value of Message Length in the Mobile Station Control Message.
:CELL:GEN:MSCM:MSL?		Returns current value of Message Length in the Mobile Station Control Message.

Table 7-1 IFR-1900 Specific Cellular Commands (cont)

COMMAND	RANGE/VALUE	DESCRIPTION
:CELL:GEN:MSCM:MST x	0 to 255	Specifies value of Message Type in the Mobile Station Control Message.
:CELL:GEN:MSCM:MST?		Returns current value of Message Type in the Mobile Station Control Message.
:CELL:GEN:MSCM:ORDQ x	0 to 7	Specifies value of Order Qualifier in the Mobile Station Control Message.
:CELL:GEN:MSCM:ORDQ?		Returns current value of Order Qualifier in the Mobile Station Control Message.
:CELL:GEN:MSCM:ORDER:x	AUDIT, LC, DIR_RTRY, INTRCPT, RELEase, REORDER, VC_DES, EXTENDED	Specifies Order in the Mobile Station Control Message.
:CELL:GEN:MSCM:REPEAT:x	ON, OFF	Sets Repeat on or off in the Mobile Station Control Message.
:CELL:GEN:MSCM:REPEAT?		Returns current setting of Repeat in the Mobile Station Control Message.
:CELL:GEN:MSCM:SCC x	0 to 3	Specifies value of Supervisory Audio Tone Color Code in the Mobile Station Control Message.
:CELL:GEN:MSCM:SCC?		Returns current value of Supervisory Audio Tone Color Code in the Mobile Station Control Message.
:CELL:GEN:MSCM:SEND		Sends the Mobile Station Control Message.
:CELL:GEN:MSCM:SETUP		Configures the IFR-1900 for the Mobile Station Control Message Screen without going to the screen.

Table 7-1 IFR-1900 Specific Cellular Commands (cont)

COMMAND	RANGE/VALUE	DESCRIPTION
:CELL:GEN:MSCM:SHORT_MESSAge " <i>string</i> "	See IS-88 Appendix A	Specifies Short Message string in Mobile Station Control Message.
:CELL:GEN:MSCM:SHORT_MESSAge?		Returns current Short Message string in Mobile Station Control Message.
:CELL:GEN:MSCM:STOP		Stops transmission of the Mobile Station Control Message.
:CELL:GEN:MSCM:VMAC x	0 to 7	Specifies value of Voice Mobile Attenuation Code in Mobile Station Control Message.
:CELL:GEN:MSCM:VMAC?		Returns current value of Voice Mobile Attenuation Code in Mobile Station Control Message.
:CELL:GEN:MSCM:VOICE_MESSAge " <i>string</i> "	See IS-88 Appendix A	Specifies Voice Mail message string in Mobile Station Control Message.
:CELL:GEN:MSCM:VOICE_MESSAge?		Returns current Voice Mail message string in Mobile Station Control Message.
:CELL:GEN:MSCM:VOICE_UNANSWERED " <i>string</i> "	00 to 99	Specifies number of unanswered messages in Mobile Station Control Message.
:CELL:GEN:MSCM:VOICE_UNANSWERED?		Returns current number of unanswered messages in Mobile Station Control Message.
:CELL:GEN:MSCM:VOICE_URGENT:x	ON or OFF	Turns on or off Urgent message identifier in Mobile Station Control Message.
:CELL:GEN:MSCM:VOICE_URGENT?		Returns current setting of Urgent message identifier in Mobile Station Control Message.

Table 7-1 IFR-1900 Specific Cellular Commands (cont)

COMMAND	RANGE/VALUE	DESCRIPTION
<b>REVERSE CONTROL CHANNEL</b>		
:CELL:GEN:RECC:CALLED_ADDRESS " <i>string</i> "	0-9, # and *. 32 characters, maximum.	Specifies Called Address.
:CELL:GEN:RECC:CALLED_ADDRESS?		Returns current Called Address.
:CELL:GEN:RECC:CHANNEL x	0 to 1023	Specifies Channel.
:CELL:GEN:RECC:CHANNEL?		Returns current Channel.
:CELL:GEN:RECC:E x	0 or 1	Sets Extended Address bit.
:CELL:GEN:RECC:E?		Returns current setting of Extended Address bit.
:CELL:GEN:RECC:EP x	0 or 1	Sets Extended Protocol bit.
:CELL:GEN:RECC:EP?		Returns current setting of Extended Protocol bit.
:CELL:GEN:RECC:ER x	0 or 1	Sets Extended Protocol Reverse Channel bit.
:CELL:GEN:RECC:ER?		Returns current setting of Extended Protocol Reverse Channel bit.
:CELL:GEN:RECC:DCC x	0 to 3	Specifies value of Digital Color Code.
:CELL:GEN:RECC:DCC?		Returns current value of Digital Color Code.
:CELL:GEN:RECC:ESN " <i>string</i> "	0-9 (Dec format), 0-7 (Oct format), 0-9, A-F (Hex format) maximum of 11 digits.	Specifies Electronic Serial Number.
:CELL:GEN:RECC:ESN?		Returns current Electronic Serial Number.
:CELL:GEN:RECC:LOCAL x	0 to 31	Specifies value of LOCAL.
:CELL:GEN:RECC:LOCAL?		Returns current value of LOCAL.
:CELL:GEN:RECC:LT x	0 or 1	Sets Last Try bit.
:CELL:GEN:RECC:LT?		Returns current setting of Last Try bit.

Table 7-1 IFR-1900 Specific Cellular Commands (cont)

COMMAND	RANGE/VALUE	DESCRIPTION
:CELL:GEN:RECC:MIN "string"	0-9, # and * separated by / (slash) and - (dash) using the format: "xxx/xxx-xxxx"	Specifies Mobile Identification Number.
:CELL:GEN:RECC:MIN?		Returns current Mobile Identification Number.
:CELL:GEN:RECC:MSL x	0 to 31	Specifies value of Message Length.
:CELL:GEN:RECC:MSL?		Returns current value of Message Length.
:CELL:GEN:RECC:MST x	0 to 255	Specifies value of Extended Protocol Message Type.
:CELL:GEN:RECC:MST?		Returns current value of Extended Protocol Message Type.
:CELL:GEN:RECC:ORDER x	0 to 31	Specifies value of Order.
:CELL:GEN:RECC:ORDER?		Returns current value of Order.
:CELL:GEN:RECC:ORDQ x	0 to 7	Specifies value of Order Qualifier.
:CELL:GEN:RECC:ORDQ?		Returns current value of Order Qualifier.
:CELL:GEN:RECC:REPEAT:x	ON or OFF	Turns Repeat on or off.
:CELL:GEN:RECC:REPEAT?		Returns current setting of Repeat.
:CELL:GEN:RECC:S x	0 or 1	Sets Serial Number bit.
:CELL:GEN:RECC:S?		Returns current setting of Serial Number bit.
:CELL:GEN:RECC:SCM x	0 to 15	Specifies value of Station Class Mark.
:CELL:GEN:RECC:SCM?		Returns current value of Station Class Mark.
:CELL:GEN:RECC:SEND		Sends Reverse Control Channel message.
:CELL:GEN:RECC:SETUP		Configures the IFR-1900 for the Reverse Control Channel Screen without going to the screen.

Table 7-1 IFR-1900 Specific Cellular Commands (cont)



COMMAND	RANGE/VALUE	DESCRIPTION
:CELL:GEN:RECC:STOP		Stops transmission of Reverse Control Channel message.
:CELL:GEN:RECC:T x	0 or 1	Sets Type of message bit.
:CELL:GEN:RECC:T?		Returns current setting of Type of message bit.
<b>FORWARD VOICE CHANNEL (AMPS)</b>		
:CELL:GEN:FVC:C12 x	0 or 1	Sets C12 bit in Mobile Station Control Message.
:CELL:GEN:FVC:C12?		Returns current setting of C12 bit in Mobile Station Control Message.
:CELL:GEN:FVC:C13 x	0 or 1	Sets C13 bit in Mobile Station Control Message.
:CELL:GEN:FVC:C13?		Returns current setting of C13 bit in Mobile Station Control Message.
:CELL:GEN:FVC:CHANNEL x	1 to 1023	Specifies Channel.
:CELL:GEN:FVC:CHANNEL?		Returns current Channel.
:CELL:GEN:FVC:CHAN x	1 to 2047	Specifies voice channel to which call is assigned in the Mobile Station Control Message.
:CELL:GEN:FVC:CHAN?		Returns current voice channel to which call is assigned in the Mobile Station Control Message.
:CELL:GEN:FVC:CLI "string"	0-9, #, * and N (Null). 32 characters, maximum.	Specifies Call Line Identifier string in the Mobile Station Control Message.
:CELL:GEN:FVC:CLI?		Returns current Call Line Identifier string in the Mobile Station Control Message.
:CELL:GEN:FVC:DSCC x	0 to 7	Specifies value of DSAT Color Code in the Mobile Station Control Message.
:CELL:GEN:FVC:DSCC?		Returns current value of DSAT Color Code in the Mobile Station Control Message.

Table 7-1 IFR-1900 Specific Cellular Commands (cont)

COMMAND	RANGE/VALUE	DESCRIPTION
:CELL:GEN:FVC:LOCAL x	0 to 31	Specifies value of LOCAL in the Mobile Station Control Message.
:CELL:GEN:FVC:LOCAL?		Returns current value of LOCAL in the Mobile Station Control Message.
:CELL:GEN:FVC:MSL x	0 to 31	Specifies value of Message Length in the Mobile Station Control Message.
:CELL:GEN:FVC:MSL?		Returns current value of Message Length in the Mobile Station Control Message.
:CELL:GEN:FVC:MST x	0 to 225	Specifies value of Message Type in the Mobile Station Control Message.
:CELL:GEN:FVC:MST?		Returns current value of Message Type in the Mobile Station Control Message.
:CELL:GEN:FVC:ORDER:x	PAGE, SNDADDR, S_ALERT, AUDIT, MAINTenance, ALERT, RELease, PWRLvl, HANDoff, NAMPS_CH_ ASGN, EXTENDED	Specifies ORDER in the Mobile Station Control Message.
:CELL:GEN:FVC:PSCC x	0 to 3	Specifies value of Present SAT Color Code in the Mobile Station Control Message.
:CELL:GEN:FVC:PSCC?		Returns current value of Present SAT Color Code in the Mobile Station Control Message.
:CELL:GEN:FVC:PWRLVL x	0 to 7	Specifies Power Level.
:CELL:GEN:FVC:PWRLVL?		Returns Power Level.
:CELL:GEN:FVC:REPEAT:x	ON or OFF	Turns Repeat on or off.
:CELL:GEN:FVC:REPEAT?		Returns current setting of Repeat.

Table 7-1 IFR-1900 Specific Cellular Commands (cont)

COMMAND	RANGE/VALUE	DESCRIPTION
:CELL:GEN:FVC:SCC x	0 to 3	Specifies value of SAT Color Code in the Mobile Station Control Message.
:CELL:GEN:FVC:SCC?		Returns current value of SAT Color Code in the Mobile Station Control Message.
:CELL:GEN:FVC:SEND		Sends the Mobile Station Control Message.
:CELL:GEN:FVC:SETUP		Configures the IFR-1900 for the AMPS Forward Voice Channel Screen without going to the screen.
:CELL:GEN:FVC:SHORT_MESSAge " <i>string</i> "	See IS-88 Appendix A	Specifies Short Message string in the Mobile Station Control Message.
:CELL:GEN:FVC:SHORT_MESSAge?		Returns current Short Message string in the Mobile Station Control Message.
:CELL:GEN:FVC:STOP		Stops the transmission of the Mobile Station Control Message.
:CELL:GEN:FVC:VMAC x	0 to 7	Specifies value of Voice Mobile Attenuation Code in the Mobile Station Control Message.
:CELL:GEN:FVC:VMAC?		Returns current value of Voice Mobile Attenuation Code in the Mobile Station Control Message.
:CELL:GEN:FVC:VOICE_MESSAge " <i>string</i> "	See IS-88 Appendix A	Specifies Voice Mail message string in the Mobile Station Control Message.
:CELL:GEN:FVC:VOICE_MESSAge?		Returns current Voice Mail message string in the Mobile Station Control Message.
:CELL:GEN:FVC:VOICE_UNANSWERED " <i>string</i> "	00 to 99	Specifies number of unanswered messages in Mobile Station Control Message.
:CELL:GEN:FVC:VOICE_UNANSWERED?		Returns current number of unanswered messages in Mobile Station Control Message.

Table 7-1 IFR-1900 Specific Cellular Commands (cont)

COMMAND	RANGE/VALUE	DESCRIPTION
:CELL:GEN:FVC:VOICE_URGENT:x	ON or OFF	Turns on or off Urgent message identifier in Mobile Station Control Message.
:CELL:GEN:FVC:VOICE_URGENT?		Returns current setting of Urgent message identifier in Mobile Station Control Message.
<b>FORWARD VOICE CHANNEL (NAMPS)</b>		
:CELL:GEN:FVC:NAMPS:BER x	0 to 127	Specifies number of allowable bit errors in Mobile Station Control Message.
:CELL:GEN:FVC:NAMPS:BER?		Returns current number of allowable bit errors in Mobile Station Control Message.
:CELL:GEN:FVC:NAMPS:C13 x	0 or 1	Sets C13 bit in Mobile Station Control Message.
:CELL:GEN:FVC:NAMPS:C13?		Returns current setting of C13 bit in Mobile Station Control Message.
:CELL:GEN:FVC:NAMPS:C12 x	0 or 1	Sets C12 bit in Mobile Station Control Message.
:CELL:GEN:FVC:NAMPS:C12?		Returns current setting of C12 bit in Mobile Station Control Message.
:CELL:GEN:FVC:NAMPS:CHANNEL x	0 to 1023	Specifies Channel.
:CELL:GEN:FVC:NAMPS:CHANNEL:x	LOWer, MIDdle, UPper	Specifies Band.
:CELL:GEN:FVC:NAMPS:CHANNEL?		Returns current Channel.
:CELL:GEN:FVC:NAMPS:DSCC x	0 to 7	Specifies value of DSAT Color Code in Mobile Station Control Message.
:CELL:GEN:FVC:NAMPS:DSCC?		Returns current value of DSAT Color Code in Mobile Station Control Message.

Table 7-1 IFR-1900 Specific Cellular Commands (cont)

COMMAND	RANGE/VALUE	DESCRIPTION
:CELL:GEN:FVC:NAMPS:CHAN x	1 to 2047	Specifies voice channel to which call is assigned in the Mobile Station Control Message. (11 least significant bits)
:CELL:GEN:FVC:NAMPS:CHAN?		Returns current voice channel to which call is assigned in the Mobile Station Control Message. (11 least significant bits)
:CELL:GEN:FVC:NAMPS:CLI "string"	0-9, #, * and N (Null). 32 characters, maximum.	Specifies Call Line Identifier string in the Mobile Station Control Message.
:CELL:GEN:FVC:NAMPS:CLI?		Returns current Call Line Identifier string in the Mobile Station Control Message.
:CELL:GEN:FVC:NAMPS:CTYP x	0 or 1	Sets Channel Type indicator in the Mobile Station Control Message.
:CELL:GEN:FVC:NAMPS:CTYP?		Returns current value of Channel Type indicator in the Mobile Station Control Message.
:CELL:GEN:FVC:NAMPS:DSAT x	0 to 6	Specifies value of Digital Supervisory Audio Tone in the Mobile Station Control Message.
:CELL:GEN:FVC:NAMPS:DSAT?		Returns current value of Digital Supervisory Audio Tone in the Mobile Station Control Message.
:CELL:GEN:FVC:NAMPS:LOCAL x	0 to 31	Specifies value of LOCAL in the Mobile Station Control Message.
:CELL:GEN:FVC:NAMPS:LOCAL?		Returns current value of LOCAL in the Mobile Station Control Message.
:CELL:GEN:FVC:NAMPS:MSL x	0 to 31	Specifies value of Message Length in the Mobile Station Control Message.
:CELL:GEN:FVC:NAMPS:MSL?		Returns current value of Message Length in the Mobile Station Control Message.

Table 7-1 IFR-1900 Specific Cellular Commands (cont)

COMMAND	RANGE/VALUE	DESCRIPTION
:CELL:GEN:FVC:NAMPS:MST x	0 to 255	Specifies value of Message Type in the Mobile Station Control Message.
:CELL:GEN:FVC:NAMPS:MST?		Returns current value of Message Type in the Mobile Station Control Message.
:CELL:GEN:FVC:NAMPS:NEXT		Sends the next word of the Mobile Station Control Message, if required.
:CELL:GEN:FVC:NAMPS:O_E x	0 or 1	Sets Odd/Even bit in the Mobile Station Control Message.
:CELL:GEN:FVC:NAMPS:O_E?		Returns current setting of Odd/Even bit in the Mobile Station Control Message.
:CELL:GEN:FVC:NAMPS:ORDER:x	PAGE, SNDADDR_EVEN SNDADDR_ODD, S_ALERT, AUDIT, MAINTenance, ALERT, RELease, FADE, SUSP_CALLED_ ADDR, HANDOFF_ CONFIRM, PWRLvl, HANDoff, MRI, EXTENDED	Specifies Order in the Mobile Station Control Message.
:CELL:GEN:FVC:NAMPS:PDSCC x	0 to 7	Specifies value of Present DSAT Color Code in the Mobile Station Control Message.
:CELL:GEN:FVC:NAMPS:PDSCC?		Returns current value of Present DSAT Color Code in the Mobile Station Control Message.
:CELL:GEN:FVC:NAMPS:PWRLVL x	0 to 7	Specifies Power Level.
:CELL:GEN:FVC:NAMPS:PWRLVL?		Returns Power Level.

Table 7-1 IFR-1900 Specific Cellular Commands (cont)

COMMAND	RANGE/VALUE	DESCRIPTION
:CELL:GEN:FVC:NAMPS:RSSI x	0 to 7	Specifies value of Received Signal Strength in the Mobile Station Control Message.
:CELL:GEN:FVC:NAMPS:RSSI?		Return current value of Received Signal Strength in the Mobile Station Control Message.
:CELL:GEN:FVC:NAMPS:SEND		Sends the Mobile Station Control Message.
:CELL:GEN:FVC:NAMPS:SETUP		Configures the IFR-1900 for the NAMPS Forward Voice Channel Screen without going to the screen.
:CELL:GEN:FVC:NAMPS:SHORT_MESSAGE "string"	See IS-88 Appendix A	Specifies Short Message string in the Mobile Station Control Message.
:CELL:GEN:FVC:NAMPS:SHORT_MESSAGE?		Returns current Short Message string in the Mobile Station Control Message.
:CELL:GEN:FVC:NAMPS:VMAC x	0 to 7	Specifies value of Voice Mobile Attenuation Code in the Mobile Station Control Message.
:CELL:GEN:FVC:NAMPS:VMAC?		Returns current value of Voice Mobile Attenuation Code in the Mobile Station Control Message.
:CELL:GEN:FVC:NAMPS:VOICE_MESSAGE "string"	See IS-88 Appendix A	Specifies Voice Mail message string in the Mobile Station Control Message.
:CELL:GEN:FVC:NAMPS:VOICE_MESSAGE?		Returns current Voice Mail message string in the Mobile Station Control Message.
:CELL:GEN:FVC:NAMPS:VOICE_UNANSWERED "string"	00 to 99	Specifies number of unanswered messages in Mobile Station Control Message.
:CELL:GEN:FVC:NAMPS:VOICE_UNANSWERED?		Returns current number of unanswered messages in Mobile Station Control Message.

Table 7-1 IFR-1900 Specific Cellular Commands (cont)

COMMAND	RANGE/VALUE	DESCRIPTION
:CELL:GEN:FVC:NAMPS:VOICE_URGENT:x	ON or OFF	Turns on or off Urgent message identifier in Mobile Station Control Message.
:CELL:GEN:FVC:NAMPS:VOICE_URGENT?		Returns current setting of Urgent message identifier in Mobile Station Control Message.
<b>REVERSE VOICE CHANNEL (AMPS)</b>		
:CELL:GEN:RVC:CALLED_ADDRESS "string"	0-9, # and *. 32 characters, maximum.	Specifies Called Address string for the Called-Address Message.
:CELL:GEN:RVC:CALLED_ADDRESS?		Returns current Called Address string for the Called-Address Message.
:CELL:GEN:RVC:CHANNEL x	0 to 1023	Specifies Channel.
:CELL:GEN:RVC:CHANNEL?		Returns current Channel.
:CELL:GEN:RVC:LOCAL x	0 to 31	Specifies value of LOCAL in Order Confirmation Message.
:CELL:GEN:RVC:LOCAL?		Returns current value of LOCAL in Order Confirmation Message.
:CELL:GEN:RVC:MESSAGE:x	ORDER_ CONFIRMation, CALLED_ ADDRESS, EXTENDED	Specifies Message to be transmitted.
:CELL:GEN:RVC:MSL x	0 to 31	Specifies value of Message Length in Extended Protocol Message.
:CELL:GEN:RVC:MSL?		Returns current value of Message Length in Extended Protocol Message.
:CELL:GEN:RVC:MST x	0 to 255	Specifies Message Type in Extended Protocol Message.
:CELL:GEN:RVC:MST?		Returns current value of Message Type in Extended Protocol Message.
:CELL:GEN:RVC:ORDER x	0 to 31	Specifies value of ORDER in Order Confirmation Message.
:CELL:GEN:RVC:ORDER?		Returns current value of ORDER in Order Confirmation Message.

Table 7-1 IFR-1900 Specific Cellular Commands (cont)



COMMAND	RANGE/VALUE	DESCRIPTION
:CELL:GEN:RVC:ORDQ x	0 to 7	Specifies value of Order Qualifier in Order Confirmation Message.
:CELL:GEN:RVC:ORDQ?		Returns current value of Order Qualifier in Order Confirmation Message.
:CELL:GEN:RVC:REPEAT:x	ON or OFF	Turns Repeat on or off.
:CELL:GEN:RVC:REPEAT?		Returns current setting of Repeat.
:CELL:GEN:RVC:SEND		Sends an RVC message.
:CELL:GEN:RVC:SETUP		Configures the IFR-1900 for the AMPS Reverse Voice Channel Screen without going to the screen.
:CELL:GEN:RVC:STOP		Stops transmission of any RVC message.
<b>REVERSE VOICE CHANNEL (NAMPS)</b>		
:CELL:GEN:RVC:NAMPS:BER x	0 to 127	Specifies number of Bit Errors in the MRI (Mobile Reported Interference) Order Message.
:CELL:GEN:RVC:NAMPS:BER?		Returns current number of Bit Errors in the MRI (Mobile Reported Interference) Order Message.
:CELL:GEN:RVC:NAMPS:CALLED_ADDRESS "string"	0-9, # and *. 32 characters, maximum.	Specifies Called Address for Flash/Called-Address Message string.
:CELL:GEN:RVC:NAMPS:CALLED_ADDRESS?		Returns current Called Address for Flash/Called-Address Message string.
:CELL:GEN:RVC:NAMPS:CHANNEL x	1 to 1023	Specifies Channel.
:CELL:GEN:RVC:NAMPS:CHANNEL:x	LOWer, MIDDLE, UPper	Specifies Band.
:CELL:GEN:RVC:NAMPS:CHANNEL?		Returns current Channel.

Table 7-1 IFR-1900 Specific Cellular Commands (cont)

COMMAND	RANGE/VALUE	DESCRIPTION
:CELL:GEN:RVC:NAMPS:CONFIRMation x	0 or 1	Sets T bit in Reverse Voice Channel Message to specify that message is a Order Confirmation Message (1) or an Order (0).
:CELL:GEN:RVC:NAMPS:CONFIRMation?		Returns current setting of T bit in Reverse Voice Channel Message to specify that message is a Order Confirmation Message (1) or an Order (0).
:CELL:GEN:RVC:NAMPS:DSAT x	0 to 6	Specifies value of Digital Supervisory Audio Tone.
:CELL:GEN:RVC:NAMPS:DSAT?		Returns current value of Digital Supervisory Audio Tone.
:CELL:GEN:RVC:NAMPS:LOCAL x	0 to 31	Specifies value of LOCAL for Order Message or Order Confirmation Message
:CELL:GEN:RVC:NAMPS:LOCAL?		Returns current value of LOCAL for Order Message or Order Confirmation Message
:CELL:GEN:RVC:NAMPS:MESSAGE:x	MRI, ORDER, FLASH	Specifies message to transmitted.
:CELL:GEN:RVC:NAMPS:NEXT		Sends the next word of the Mobile Station Control Message, if required.
:CELL:GEN:RVC:NAMPS:O_E x	0 or 1	Sets Odd/Even bit.
:CELL:GEN:RVC:NAMPS:O_E?		Returns current setting of Odd/Even bit.
:CELL:GEN:RVC:NAMPS:ORDQ x	0 to 7	Specifies value of Order Qualifier for order messages,
:CELL:GEN:RVC:NAMPS:ORDQ?		Returns current value of Order Qualifier for order messages,
:CELL:GEN:RVC:NAMPS:ORDER x	0 to 31	Specifies value of ORDER for order messages.
:CELL:GEN:RVC:NAMPS:ORDER?		Returns current value of ORDER for order messages.

Table 7-1 IFR-1900 Specific Cellular Commands (cont)

COMMAND	RANGE/VALUE	DESCRIPTION
:CELL:GEN:RVC:NAMPS:RSSI x	0 to 7	Specifies value of Received Signal Strength in MRI (Mobile Reported Interference) Order Message.
:CELL:GEN:RVC:NAMPS:RSSI?		Returns current value of Received Signal Strength in MRI (Mobile Reported Interference) Order Message.
:CELL:GEN:RVC:NAMPS:SEND		Sends message.
:CELL:GEN:RVC:NAMPS:SETUP		Configures the IFR-1900 for the NAMPS Reverse Voice Channel Screen without going to the screen.
:CELL:GEN:RVC:NAMPS:VMAC x	0 to 7	Specifies value of Voice Mobile Attenuation Code in Order Messages.
:CELL:GEN:RVC:NAMPS:VMAC?		Returns current value of Voice Mobile Attenuation Code in Order Messages.

Table 7-1 IFR-1900 Specific Cellular Commands (cont)

# APPENDIX A - USER I/O CONNECTORS AND PIN-OUT TABLES

## A-1 TABLE OF I/O CONNECTORS

CONNECTOR NAME	CONNECTOR TYPE	SIGNAL IN/OUT	SIGNAL TYPE
T/R	"N" TYPE	IN/OUT	RF
SCOPE IN	BNC	IN	Analog
DMM AMP	Banana Jack	IN	AC/DC
DMM COM	Banana Jack	IN	GND
DMM V $\Omega$	Banana Jack	IN	AC/DC
DEMOD OUT	BNC	OUT	Audio
AUDIO OUT	BNC	OUT	Audio
SINAD/BER IN	BNC	IN	Analog - SINAD Digital - BER
EXT MOD IN	BNC	IN	Audio
MIC/ACC	8 Pin DIN	IN/OUT	See Pin-Out (A-2)
DUPLEX OUT	TNC	OUT	RF
ANTENNA IN	TNC	IN	RF
AC LINE IN	AC Power	IN	105-130, 210-260 VAC Auto-switching 115/230 V
SCSI	50 Pin Champ	IN/OUT	See Pin-Out (A-3)
GPB (IEEE-488)	24 Pin Champ	IN/OUT	See Pin-Out (A-4)
AUXILIARY I/O	Reserved for Future Use		
HOST RS-232	9 Pin, D	IN/OUT	See Pin-Out (A-5)
EXTERNAL VIDEO	9 Pin, D	OUT	Video, VGA Format, See Pin-Out (A-6)
10 MHz REFERENCE IN	BNC	IN	10 MHz, Sine/Square
10 MHz REFERENCE OUT	BNC	OUT	10 MHz, TTL, driven by internal Master Oscillator
PRINTER	25 Pin, D	OUT	Centronics-compatible. See Pin-Out (A-7)
GENERATOR IF IN	Reserved for Future Use		
GENERATOR IF OUT			
RECEIVER IF			

Table A-1 Table of I/O Connectors

CONNECTOR NAME	CONNECTOR TYPE	SIGNAL IN/OUT	SIGNAL TYPE
OPTIONAL RS-232	See IFR-1900 CSA Option Operation Manual		
SYNC OUT			
I (GENERATOR BASEBAND OUT)			
Q (GENERATOR BASEBAND OUT)			

Table A-1 Table of I/O Connectors (cont)

## A-2 PIN-OUT TABLE FOR MIC/ACC CONNECTOR

PIN NUMBER	SIGNAL NAME	SIGNAL TYPE	I/O
1	PTT-Out	TTL	Programmable Out
2	Mic Audio	Audio	In
3	Demod Audio	Audio	Out
4	ACC-2	TTL	Programmable In
5	+15 Vdc	10-15 Vdc, 1 mA	Out
6	ACC-1	TTL	Programmable In
7	Mic Switch	TTL	Programmable In
8	GND		

Table A-2 Pin-Out for MIC/ACC Connector



8618013

Figure A-1 MIC/ACC Connector Pin Identification

### A-3 PIN-OUT TABLE FOR SCSI CONNECTOR

PIN NUMBER	ASSIGNMENT	PIN NUMBER	ASSIGNMENT
1-25	Digital GND	39	Digital GND
26	SD0	40	Digital GND
27	SD1	41	ATN
28	SD2	42	Digital GND
29	SD3	43	BSY
30	SD4	44	ACK
31	SD5	45	RST
32	SD6	46	MSG
33	SD7	47	SEL
34	SD8	48	C/D
35-37	Digital GND	49	REQ
38	TERM PWR	50	I/O

Table A-3 Pin-Out for SCSI Connector

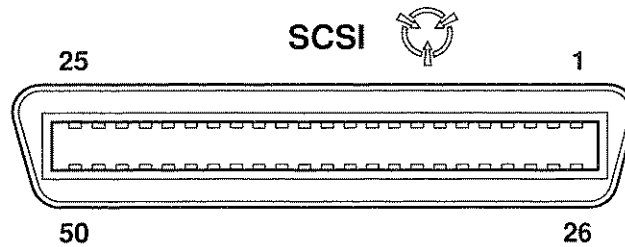

Figure A-2 SCSI Connector Pin Identification

Use of the SCSI Connector conforms with the Common Command Set (CCS) of the Small Computer System Interface (SCSI) published by the ANSI X3T9.2 Committee as X3T9.2/85-52 Rev 4.B.

8618015

#### A-4 PIN-OUT TABLE FOR GPIB CONNECTOR

PIN NUMBER	ASSIGNMENT	PIN NUMBER	ASSIGNMENT
1	DIO 1	10	SRO
2	DIO 2	11	ATN
3	DIO 3	12	Digital GND
4	DIO 4	13	DIO 5
5	EOI	14	DIO 6
6	DAV	15	DIO 7
7	NFRD	16	DIO 8
8	NDAC	17	REN
9	IFC	18-24	Digital GND

Table A-4 Pin-Out for GPIB Connector

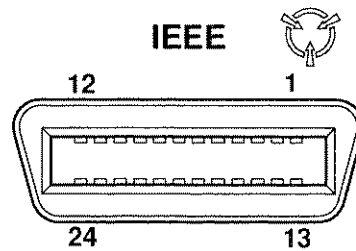

8618016

Figure A-3 GPIB Connector Pin Identification

Use of the GPIB Connector is in compliance with ANSI/IEEE Standard 488.2-1987.



## A-5 PIN-OUT TABLE FOR HOST RS-232 CONNECTOR

PIN NUMBER	ASSIGNMENT
1	4.7 k $\Omega$ , + 15Vdc
2	TX DATA
3	RX DATA
4	N/C
5	Digital GND
6	4.7 k $\Omega$ , + 15Vdc
7	CTS
8	RTS
9	N/C

Table A-5 Pin-Out for HOST RS-232 Connector

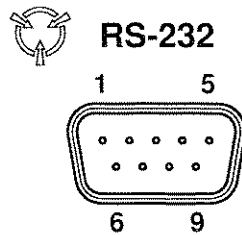

8618017

Figure A-4 HOST RS-232 Connector Pin Identification

## A-6 PIN-OUT TABLE FOR EXTERNAL VIDEO CONNECTOR

PIN NUMBER	ASSIGNMENT	PIN NUMBER	ASSIGNMENT
1	Red	9	Not Used
2	Green	10	Digital GND
3	Blue	11	Digital GND
4	Not Used	12	Digital GND
5	Digital GND	13	Horizontal Sync
6	Red Return	14	Vertical Sync
7	Green Return	15	Not Used
8	Blue Return		

Table A-6 Pin-Out for EXTERNAL VIDEO Connector

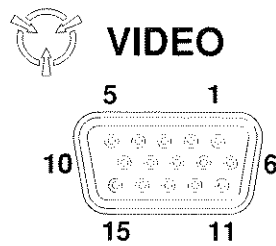

03418003

Figure A-5 EXTERNAL VIDEO Connector Pin Identification

## A-7 PIN-OUT TABLE FOR PRINTER CONNECTOR

PIN NUMBER	ASSIGNMENT	PIN NUMBER	ASSIGNMENT
1	$\overline{\text{STB}}$	10	$\overline{\text{ACK}}$
2	PD0	11	BUSY
3	PD1	12	PE
4	PD2	13	SLCT
5	PD3	14	$\overline{\text{AFD}}$
6	PD4	15	ERROR
7	PD5	16	$\overline{\text{INIT}}$
8	PD6	17	$\overline{\text{SLIN}}$
9	PD7	18-25	Ground

Table A-7 Pin-Out for Printer Connector

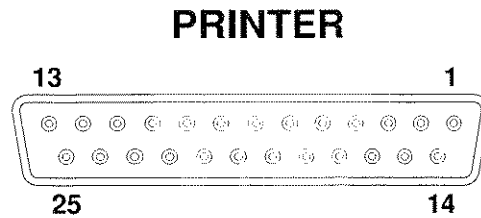

Figure A-6 Printer Connector Pin Identification

03418004

## APPENDIX B - NADC/NAMPS CELLULAR TELEPHONE CHANNEL NUMBERS AND CENTER FREQUENCIES

The following is a listing of NADC/NAMPS cellular telephone channel numbers and center frequencies. NADC-U4 corresponds to the NT-400© (450 MHz) band, NADC-U8 to the AMPS (800 MHz) band and NADC-HY to the 1900 MHz Hyperband. The frequencies listed for the NADC-U8 band correspond to the middle channels of a NAMPS cellular system. The NAMPS upper and lower channels are 10 kHz above and 10 kHz below, respectively.

CHANNEL NUMBER	BAND					
	NADC-U4		NADC-U8		NADC-HY	
	MOBILE TRANSMIT (MHz)	MOBILE RECEIVE (MHz)	MOBILE TRANSMIT (MHz)	MOBILE RECEIVE (MHz)	MOBILE TRANSMIT (MHz)	MOBILE RECEIVE (MHz)
1	440.010	485.010	825.030	870.030	1850.010	1930.050
2	440.040	485.040	825.060	870.060	1850.040	1930.080
3	440.070	485.070	825.090	870.090	1850.070	1930.110
4	440.100	485.100	825.120	870.120	1850.100	1930.140
5	440.130	485.130	825.150	870.150	1850.130	1930.170
6	440.160	485.160	825.180	870.180	1850.160	1930.200
7	440.190	485.190	825.210	870.210	1850.190	1930.230
8	440.220	485.220	825.240	870.240	1850.220	1930.260
9	440.250	485.250	825.270	870.270	1850.250	1930.290
10	440.280	485.280	825.300	870.300	1850.280	1930.320
11	440.310	485.310	825.330	870.330	1850.310	1930.350
12	440.340	485.340	825.360	870.360	1850.340	1930.380
13	440.370	485.370	825.390	870.390	1850.370	1930.410
14	440.400	485.400	825.420	870.420	1850.400	1930.440
15	440.430	485.430	825.450	870.450	1850.430	1930.470
16	440.460	485.460	825.480	870.480	1850.460	1930.500
17	440.490	485.490	825.510	870.510	1850.490	1930.530
18	440.520	485.520	825.540	870.540	1850.520	1930.560
19	440.550	485.550	825.570	870.570	1850.550	1930.590
20	440.580	485.580	825.600	870.600	1850.580	1930.620
21	440.610	485.610	825.630	870.630	1850.610	1930.650
22	440.640	485.640	825.660	870.660	1850.640	1930.680
23	440.670	485.670	825.690	870.690	1850.670	1930.710
24	440.700	485.700	825.720	870.720	1850.700	1930.740
25	440.730	485.730	825.750	870.750	1850.730	1930.770
26	440.760	485.760	825.780	870.780	1850.760	1930.800
27	440.790	485.790	825.810	870.810	1850.790	1930.830
28	440.820	485.820	825.840	870.840	1850.820	1930.860
29	440.850	485.850	825.870	870.870	1850.850	1930.890
30	440.880	485.880	825.900	870.900	1850.880	1930.920
31	440.910	485.910	825.930	870.930	1850.910	1930.950
32	440.940	485.940	825.960	870.960	1850.940	1930.980
33	440.970	485.970	825.990	870.990	1850.970	1931.010
34	441.000	486.000	826.020	871.020	1851.000	1931.040
35	441.030	486.030	826.050	871.050	1851.030	1931.070
36	441.060	486.060	826.080	871.080	1851.060	1931.100
37	441.090	486.090	826.110	871.110	1851.090	1931.130
38	441.120	486.120	826.140	871.140	1851.120	1931.160
39	441.150	486.150	826.170	871.170	1851.150	1931.190
40	441.180	486.180	826.200	871.200	1851.180	1931.220

Table B-1 NADC/NAMPS Cellular Channel Numbers and Frequencies

CHANNEL NUMBER	BAND					
	NADC-U4		NADC-U8		NADC-HY	
	MOBILE TRANSMIT (MHz)	MOBILE RECEIVE (MHz)	MOBILE TRANSMIT (MHz)	MOBILE RECEIVE (MHz)	MOBILE TRANSMIT (MHz)	MOBILE RECEIVE (MHz)
41	441.210	486.210	826.230	871.230	1851.210	1931.250
42	441.240	486.240	826.260	871.260	1851.240	1931.280
43	441.270	486.270	826.290	871.290	1851.270	1931.310
44	441.300	486.300	826.320	871.320	1851.300	1931.340
45	441.330	486.330	826.350	871.350	1851.330	1931.370
46	441.360	486.360	826.380	871.380	1851.360	1931.400
47	441.390	486.390	826.410	871.410	1851.390	1931.430
48	441.420	486.420	826.440	871.440	1851.420	1931.460
49	441.450	486.450	826.470	871.470	1851.450	1931.490
50	441.480	486.480	826.500	871.500	1851.480	1931.520
51	441.510	486.510	826.530	871.530	1851.510	1931.550
52	441.540	486.540	826.560	871.560	1851.540	1931.580
53	441.570	486.570	826.590	871.590	1851.570	1931.610
54	441.600	486.600	826.620	871.620	1851.600	1931.640
55	441.630	486.630	826.650	871.650	1851.630	1931.670
56	441.660	486.660	826.680	871.680	1851.660	1931.700
57	441.690	486.690	826.710	871.710	1851.690	1931.730
58	441.720	486.720	826.740	871.740	1851.720	1931.760
59	441.750	486.750	826.770	871.770	1851.750	1931.790
60	441.780	486.780	826.800	871.800	1851.780	1931.820
61	441.810	486.810	826.830	871.830	1851.810	1931.850
62	441.840	486.840	826.860	871.860	1851.840	1931.880
63	441.870	486.870	826.890	871.890	1851.870	1931.910
64	441.900	486.900	826.920	871.920	1851.900	1931.940
65	441.930	486.930	826.950	871.950	1851.930	1931.970
66	441.960	486.960	826.980	871.980	1851.960	1932.000
67	441.990	486.990	827.010	872.010	1851.990	1932.030
68	442.020	487.020	827.040	872.040	1852.020	1932.060
69	442.050	487.050	827.070	872.070	1852.050	1932.090
70	442.080	487.080	827.100	872.100	1852.080	1932.120
71	442.110	487.110	827.130	872.130	1852.110	1932.150
72	442.140	487.140	827.160	872.160	1852.140	1932.180
73	442.170	487.170	827.190	872.190	1852.170	1932.210
74	442.200	487.200	827.220	872.220	1852.200	1932.240
75	442.230	487.230	827.250	872.250	1852.230	1932.270
76	442.260	487.260	827.280	872.280	1852.260	1932.300
77	442.290	487.290	827.310	872.310	1852.290	1932.330
78	442.320	487.320	827.340	872.340	1852.320	1932.360
79	442.350	487.350	827.370	872.370	1852.350	1932.390
80	442.380	487.380	827.400	872.400	1852.380	1932.420

Table B-1 NADC/NAMPS Cellular Channel Numbers and Frequencies (cont)

CHANNEL NUMBER	BAND					
	NADC-U4		NADC-U8		NADC-HY	
	MOBILE TRANSMIT (MHz)	MOBILE RECEIVE (MHz)	MOBILE TRANSMIT (MHz)	MOBILE RECEIVE (MHz)	MOBILE TRANSMIT (MHz)	MOBILE RECEIVE (MHz)
81	442.410	487.410	827.430	872.430	1852.410	1932.450
82	442.440	487.440	827.460	872.460	1852.440	1932.480
83	442.470	487.470	827.490	872.490	1852.470	1932.510
84	442.500	487.500	827.520	872.520	1852.500	1932.540
85	442.530	487.530	827.550	872.550	1852.530	1932.570
86	442.560	487.560	827.580	872.580	1852.560	1932.600
87	442.590	487.590	827.610	872.610	1852.590	1932.630
88	442.620	487.620	827.640	872.640	1852.620	1932.660
89	442.650	487.650	827.670	872.670	1852.650	1932.690
90	442.680	487.680	827.700	872.700	1852.680	1932.720
91	442.710	487.710	827.730	872.730	1852.710	1932.750
92	442.740	487.740	827.760	872.760	1852.740	1932.780
93	442.770	487.770	827.790	872.790	1852.770	1932.810
94	442.800	487.800	827.820	872.820	1852.800	1932.840
95	442.830	487.830	827.850	872.850	1852.830	1932.870
96	442.860	487.860	827.880	872.880	1852.860	1932.900
97	442.890	487.890	827.910	872.910	1852.890	1932.930
98	442.920	487.920	827.940	872.940	1852.920	1932.960
99	442.950	487.950	827.970	872.970	1852.950	1932.990
100	442.980	487.980	828.000	873.000	1852.980	1933.020
101	443.010	488.010	828.030	873.030	1853.010	1933.050
102	443.040	488.040	828.060	873.060	1853.040	1933.080
103	443.070	488.070	828.090	873.090	1853.070	1933.110
104	443.100	488.100	828.120	873.120	1853.100	1933.140
105	443.130	488.130	828.150	873.150	1853.130	1933.170
106	443.160	488.160	828.180	873.180	1853.160	1933.200
107	443.190	488.190	828.210	873.210	1853.190	1933.230
108	443.220	488.220	828.240	873.240	1853.220	1933.260
109	443.250	488.250	828.270	873.270	1853.250	1933.290
110	443.280	488.280	828.300	873.300	1853.280	1933.320
111	443.310	488.310	828.330	873.330	1853.310	1933.350
112	443.340	488.340	828.360	873.360	1853.340	1933.380
113	443.370	488.370	828.390	873.390	1853.370	1933.410
114	443.400	488.400	828.420	873.420	1853.400	1933.440
115	443.430	488.430	828.450	873.450	1853.430	1933.470
116	443.460	488.460	828.480	873.480	1853.460	1933.500
117	443.490	488.490	828.510	873.510	1853.490	1933.530
118	443.520	488.520	828.540	873.540	1853.520	1933.560
119	443.550	488.550	828.570	873.570	1853.550	1933.590
120	443.580	488.580	828.600	873.600	1853.580	1933.620

Table B-1 NADC/NAMPS Cellular Channel Numbers and Frequencies (cont)

CHANNEL NUMBER	BAND					
	NADC-U4		NADC-U8		NADC-HY	
	MOBILE TRANSMIT (MHz)	MOBILE RECEIVE (MHz)	MOBILE TRANSMIT (MHz)	MOBILE RECEIVE (MHz)	MOBILE TRANSMIT (MHz)	MOBILE RECEIVE (MHz)
121	443.610	488.610	828.630	873.630	1853.610	1933.650
122	443.640	488.640	828.660	873.660	1853.640	1933.680
123	443.670	488.670	828.690	873.690	1853.670	1933.710
124	443.700	488.700	828.720	873.720	1853.700	1933.740
125	443.730	488.730	828.750	873.750	1853.730	1933.770
126	443.760	488.760	828.780	873.780	1853.760	1933.800
127	443.790	488.790	828.810	873.810	1853.790	1933.830
128	443.820	488.820	828.840	873.840	1853.820	1933.860
129	443.850	488.850	828.870	873.870	1853.850	1933.890
130	443.880	488.880	828.900	873.900	1853.880	1933.920
131	443.910	488.910	828.930	873.930	1853.910	1933.950
132	443.940	488.940	828.960	873.960	1853.940	1933.980
133	443.970	488.970	828.990	873.990	1853.970	1934.010
134	444.000	489.000	829.020	874.020	1854.000	1934.040
135	444.030	489.030	829.050	874.050	1854.030	1934.070
136	444.060	489.060	829.080	874.080	1854.060	1934.100
137	444.090	489.090	829.110	874.110	1854.090	1934.130
138	444.120	489.120	829.140	874.140	1854.120	1934.160
139	444.150	489.150	829.170	874.170	1854.150	1934.190
140	444.180	489.180	829.200	874.200	1854.180	1934.220
141	444.210	489.210	829.230	874.230	1854.210	1934.250
142	444.240	489.240	829.260	874.260	1854.240	1934.280
143	444.270	489.270	829.290	874.290	1854.270	1934.310
144	444.300	489.300	829.320	874.320	1854.300	1934.340
145	444.330	489.330	829.350	874.350	1854.330	1934.370
146	444.360	489.360	829.380	874.380	1854.360	1934.400
147	444.390	489.390	829.410	874.410	1854.390	1934.430
148	444.420	489.420	829.440	874.440	1854.420	1934.460
149	444.450	489.450	829.470	874.470	1854.450	1934.490
150	444.480	489.480	829.500	874.500	1854.480	1934.520
151	444.510	489.510	829.530	874.530	1854.510	1934.550
152	444.540	489.540	829.560	874.560	1854.540	1934.580
153	444.570	489.570	829.590	874.590	1854.570	1934.610
154	444.600	489.600	829.620	874.620	1854.600	1934.640
155	444.630	489.630	829.650	874.650	1854.630	1934.670
156	444.660	489.660	829.680	874.680	1854.660	1934.700
157	444.690	489.690	829.710	874.710	1854.690	1934.730
158	444.720	489.720	829.740	874.740	1854.720	1934.760
159	444.750	489.750	829.770	874.770	1854.750	1934.790
160	444.780	489.780	829.800	874.800	1854.780	1934.820

Table B-1 NADC/NAMPS Cellular Channel Numbers and Frequencies (cont)

CHANNEL NUMBER	BAND					
	NADC-U4		NADC-U8		NADC-HY	
	MOBILE TRANSMIT (MHz)	MOBILE RECEIVE (MHz)	MOBILE TRANSMIT (MHz)	MOBILE RECEIVE (MHz)	MOBILE TRANSMIT (MHz)	MOBILE RECEIVE (MHz)
161	444.810	489.810	829.830	874.830	1854.810	1934.850
162	444.840	489.840	829.860	874.860	1854.840	1934.880
163	444.870	489.870	829.890	874.890	1854.870	1934.910
164	444.900	489.900	829.920	874.920	1854.900	1934.940
165	444.930	489.930	829.950	874.950	1854.930	1934.970
166	444.960	489.960	829.980	874.980	1854.960	1935.000
167	444.990	489.990	830.010	875.010	1854.990	1935.030
168	445.020	490.020	830.040	875.040	1855.020	1935.060
169	445.050	490.050	830.070	875.070	1855.050	1935.090
170	445.080	490.080	830.100	875.100	1855.080	1935.120
171	445.110	490.110	830.130	875.130	1855.110	1935.150
172	445.140	490.140	830.160	875.160	1855.140	1935.180
173	445.170	490.170	830.190	875.190	1855.170	1935.210
174	445.200	490.200	830.220	875.220	1855.200	1935.240
175	445.230	490.230	830.250	875.250	1855.230	1935.270
176	445.260	490.260	830.280	875.280	1855.260	1935.300
177	445.290	490.290	830.310	875.310	1855.290	1935.330
178	445.320	490.320	830.340	875.340	1855.320	1935.360
179	445.350	490.350	830.370	875.370	1855.350	1935.390
180	445.380	490.380	830.400	875.400	1855.380	1935.420
181	445.410	490.410	830.430	875.430	1855.410	1935.450
182	445.440	490.440	830.460	875.460	1855.440	1935.480
183	445.470	490.470	830.490	875.490	1855.470	1935.510
184	445.500	490.500	830.520	875.520	1855.500	1935.540
185	445.530	490.530	830.550	875.550	1855.530	1935.570
186	445.560	490.560	830.580	875.580	1855.560	1935.600
187	445.590	490.590	830.610	875.610	1855.590	1935.630
188	445.620	490.620	830.640	875.640	1855.620	1935.660
189	445.650	490.650	830.670	875.670	1855.650	1935.690
190	445.680	490.680	830.700	875.700	1855.680	1935.720
191	445.710	490.710	830.730	875.730	1855.710	1935.750
192	445.740	490.740	830.760	875.760	1855.740	1935.780
193	445.770	490.770	830.790	875.790	1855.770	1935.810
194	445.800	490.800	830.820	875.820	1855.800	1935.840
195	445.830	490.830	830.850	875.850	1855.830	1935.870
196	445.860	490.860	830.880	875.880	1855.860	1935.900
197	445.890	490.890	830.910	875.910	1855.890	1935.930
198	445.920	490.920	830.940	875.940	1855.920	1935.960
199	445.950	490.950	830.970	875.970	1855.950	1935.990

Table B-1 NADC/NAMPS Cellular Channel Numbers and Frequencies (cont)



CHANNEL NUMBER	BAND					
	NADC-U4		NADC-U8		NADC-HY	
	MOBILE TRANSMIT (MHz)	MOBILE RECEIVE (MHz)	MOBILE TRANSMIT (MHz)	MOBILE RECEIVE (MHz)	MOBILE TRANSMIT (MHz)	MOBILE RECEIVE (MHz)
200	445.980	490.980	831.000	876.000	1855.980	1936.020
201	446.010	491.010	831.030	876.030	1856.010	1936.050
202	446.040	491.040	831.060	876.060	1856.040	1936.080
203	446.070	491.070	831.090	876.090	1856.070	1936.110
204	446.100	491.100	831.120	876.120	1856.100	1936.140
205	446.130	491.130	831.150	876.150	1856.130	1936.170
206	446.160	491.160	831.180	876.180	1856.160	1936.200
207	446.190	491.190	831.210	876.210	1856.190	1936.230
208	446.220	491.220	831.240	876.240	1856.220	1936.260
209	446.250	491.250	831.270	876.270	1856.250	1936.290
210	446.280	491.280	831.300	876.300	1856.280	1936.320
211	446.310	491.310	831.330	876.330	1856.310	1936.350
212	446.340	491.340	831.360	876.360	1856.340	1936.380
213	446.370	491.370	831.390	876.390	1856.370	1936.410
214	446.400	491.400	831.420	876.420	1856.400	1936.440
215	446.430	491.430	831.450	876.450	1856.430	1936.470
216	446.460	491.460	831.480	876.480	1856.460	1936.500
217	446.490	491.490	831.510	876.510	1856.490	1936.530
218	446.520	491.520	831.540	876.540	1856.520	1936.560
219	446.550	491.550	831.570	876.570	1856.550	1936.590
220	446.580	491.580	831.600	876.600	1856.580	1936.620
221	446.610	491.610	831.630	876.630	1856.610	1936.650
222	446.640	491.640	831.660	876.660	1856.640	1936.680
223	446.670	491.670	831.690	876.690	1856.670	1936.710
224	446.700	491.700	831.720	876.720	1856.700	1936.740
225	446.730	491.730	831.750	876.750	1856.730	1936.770
226	446.760	491.760	831.780	876.780	1856.760	1936.800
227	446.790	491.790	831.810	876.810	1856.790	1936.830
228	446.820	491.820	831.840	876.840	1856.820	1936.860
229	446.850	491.850	831.870	876.870	1856.850	1936.890
230	446.880	491.880	831.900	876.900	1856.880	1936.920
231	446.910	491.910	831.930	876.930	1856.910	1936.950
232	446.940	491.940	831.960	876.960	1856.940	1936.980
233	446.970	491.970	831.990	876.990	1856.970	1937.010
234	447.000	492.000	832.020	877.020	1857.000	1937.040
235	447.030	492.030	832.050	877.050	1857.030	1937.070
236	447.060	492.060	832.080	877.080	1857.060	1937.100
237	447.090	492.090	832.110	877.110	1857.090	1937.130
238	447.120	492.120	832.140	877.140	1857.120	1937.160
239	447.150	492.150	832.170	877.170	1857.150	1937.190
240	447.180	492.180	832.200	877.200	1857.180	1937.220

Table B-1 NADC/NAMPS Cellular Channel Numbers and Frequencies (cont)

CHANNEL NUMBER	BAND					
	NADC-U4		NADC-U8		NADC-HY	
	MOBILE TRANSMIT (MHz)	MOBILE RECEIVE (MHz)	MOBILE TRANSMIT (MHz)	MOBILE RECEIVE (MHz)	MOBILE TRANSMIT (MHz)	MOBILE RECEIVE (MHz)
241	447.210	492.210	832.230	877.230	1857.210	1937.250
242	447.240	492.240	832.260	877.260	1857.240	1937.280
243	447.270	492.270	832.290	877.290	1857.270	1937.310
244	447.300	492.300	832.320	877.320	1857.300	1937.340
245	447.330	492.330	832.350	877.350	1857.330	1937.370
246	447.360	492.360	832.380	877.380	1857.360	1937.400
247	447.390	492.390	832.410	877.410	1857.390	1937.430
248	447.420	492.420	832.440	877.440	1857.420	1937.460
249	447.450	492.450	832.470	877.470	1857.450	1937.490
250	447.480	492.480	832.500	877.500	1857.480	1937.520
251	447.510	492.510	832.530	877.530	1857.510	1937.550
252	447.540	492.540	832.560	877.560	1857.540	1937.580
253	447.570	492.570	832.590	877.590	1857.570	1937.610
254	447.600	492.600	832.620	877.620	1857.600	1937.640
255	447.630	492.630	832.650	877.650	1857.630	1937.670
256	447.660	492.660	832.680	877.680	1857.660	1937.700
257	447.690	492.690	832.710	877.710	1857.690	1937.730
258	447.720	492.720	832.740	877.740	1857.720	1937.760
259	447.750	492.750	832.770	877.770	1857.750	1937.790
260	447.780	492.780	832.800	877.800	1857.780	1937.820
261	447.810	492.810	832.830	877.830	1857.810	1937.850
262	447.840	492.840	832.860	877.860	1857.840	1937.880
263	447.870	492.870	832.890	877.890	1857.870	1937.910
264	447.900	492.900	832.920	877.920	1857.900	1937.940
265	447.930	492.930	832.950	877.950	1857.930	1937.970
266	447.960	492.960	832.980	877.980	1857.960	1938.000
267	447.990	492.990	833.010	878.010	1857.990	1938.030
268	448.020	493.020	833.040	878.040	1858.020	1938.060
269	448.050	493.050	833.070	878.070	1858.050	1938.090
270	448.080	493.080	833.100	878.100	1858.080	1938.120
271	448.110	493.110	833.130	878.130	1858.110	1938.150
272	448.140	493.140	833.160	878.160	1858.140	1938.180
273	448.170	493.170	833.190	878.190	1858.170	1938.210
274	448.200	493.200	833.220	878.220	1858.200	1938.240
275	448.230	493.230	833.250	878.250	1858.230	1938.270
276	448.260	493.260	833.280	878.280	1858.260	1938.300
277	448.290	493.290	833.310	878.310	1858.290	1938.330
278	448.320	493.320	833.340	878.340	1858.320	1938.360
279	448.350	493.350	833.370	878.370	1858.350	1938.390
280	448.380	493.380	833.400	878.400	1858.380	1938.420

Table B-1 NADC/NAMPS Cellular Channel Numbers and Frequencies (cont)

CHANNEL NUMBER	BAND					
	NADC-U4		NADC-U8		NADC-HY	
	MOBILE TRANSMIT (MHz)	MOBILE RECEIVE (MHz)	MOBILE TRANSMIT (MHz)	MOBILE RECEIVE (MHz)	MOBILE TRANSMIT (MHz)	MOBILE RECEIVE (MHz)
281	448.410	493.410	833.430	878.430	1858.410	1938.450
282	448.440	493.440	833.460	878.460	1858.440	1938.480
283	448.470	493.470	833.490	878.490	1858.470	1938.510
284	448.500	493.500	833.520	878.520	1858.500	1938.540
285	448.530	493.530	833.550	878.550	1858.530	1938.570
286	448.560	493.560	833.580	878.580	1858.560	1938.600
287	448.590	493.590	833.610	878.610	1858.590	1938.630
288	448.620	493.620	833.640	878.640	1858.620	1938.660
289	448.650	493.650	833.670	878.670	1858.650	1938.690
290	448.680	493.680	833.700	878.700	1858.680	1938.720
291	448.710	493.710	833.730	878.730	1858.710	1938.750
292	448.740	493.740	833.760	878.760	1858.740	1938.780
293	448.770	493.770	833.790	878.790	1858.770	1938.810
294	448.800	493.800	833.820	878.820	1858.800	1938.840
295	448.830	493.830	833.850	878.850	1858.830	1938.870
296	448.860	493.860	833.880	878.880	1858.860	1938.900
297	448.890	493.890	833.910	878.910	1858.890	1938.930
298	448.920	493.920	833.940	878.940	1858.920	1938.960
299	448.950	493.950	833.970	878.970	1858.950	1938.990
300	448.980	493.980	834.000	879.000	1858.980	1939.020
301	449.010	494.010	834.030	879.030	1859.010	1939.050
302	449.040	494.040	834.060	879.060	1859.040	1939.080
303	449.070	494.070	834.090	879.090	1859.070	1939.110
304	449.100	494.100	834.120	879.120	1859.100	1939.140
305	449.130	494.130	834.150	879.150	1859.130	1939.170
306	449.160	494.160	834.180	879.180	1859.160	1939.200
307	449.190	494.190	834.210	879.210	1859.190	1939.230
308	449.220	494.220	834.240	879.240	1859.220	1939.260
309	449.250	494.250	834.270	879.270	1859.250	1939.290
310	449.280	494.280	834.300	879.300	1859.280	1939.320
311	449.310	494.310	834.330	879.330	1859.310	1939.350
312	449.340	494.340	834.360	879.360	1859.340	1939.380
313	449.370	494.370	834.390	879.390	1859.370	1939.410
314	449.400	494.400	834.420	879.420	1859.400	1939.440
315	449.430	494.430	834.450	879.450	1859.430	1939.470
316	449.460	494.460	834.480	879.480	1859.460	1939.500
317	449.490	494.490	834.510	879.510	1859.490	1939.530
318	449.520	494.520	834.540	879.540	1859.520	1939.560
319	449.550	494.550	834.570	879.570	1859.550	1939.590
320	449.580	494.580	834.600	879.600	1859.580	1939.620

Table B-1 NADC/NAMPS Cellular Channel Numbers and Frequencies (cont)

CHANNEL NUMBER	BAND					
	NADC-U4		NADC-U8		NADC-HY	
	MOBILE TRANSMIT (MHz)	MOBILE RECEIVE (MHz)	MOBILE TRANSMIT (MHz)	MOBILE RECEIVE (MHz)	MOBILE TRANSMIT (MHz)	MOBILE RECEIVE (MHz)
321	449.610	494.610	834.630	879.630	1859.610	1939.650
322	449.640	494.640	834.660	879.660	1859.640	1939.680
323	449.670	494.670	834.690	879.690	1859.670	1939.710
324	449.700	494.700	834.720	879.720	1859.700	1939.740
325	449.730	494.730	834.750	879.750	1859.730	1939.770
326	449.760	494.760	834.780	879.780	1859.760	1939.800
327	449.790	494.790	834.810	879.810	1859.790	1939.830
328	449.820	494.820	834.840	879.840	1859.820	1939.860
329	449.850	494.850	834.870	879.870	1859.850	1939.890
330	449.880	494.880	834.900	879.900	1859.880	1939.920
331	449.910	494.910	834.930	879.930	1859.910	1939.950
332	449.940	494.940	834.960	879.960	1859.940	1939.980
333	449.970	494.970	834.990	879.990	1859.970	1940.010
334			835.020	880.020	1860.000	1940.040
335			835.050	880.050	1860.030	1940.070
336			835.080	880.080	1860.060	1940.100
337			835.110	880.110	1860.090	1940.130
338			835.140	880.140	1860.120	1940.160
339			835.170	880.170	1860.150	1940.190
340			835.200	880.200	1860.180	1940.220
341			835.230	880.230	1860.210	1940.250
342			835.260	880.260	1860.240	1940.280
343			835.290	880.290	1860.270	1940.310
344			835.320	880.320	1860.300	1940.340
345			835.350	880.350	1860.330	1940.370
346			835.380	880.380	1860.360	1940.400
347			835.410	880.410	1860.390	1940.430
348			835.440	880.440	1860.420	1940.460
349			835.470	880.470	1860.450	1940.490
350			835.500	880.500	1860.480	1940.520
351			835.530	880.530	1860.510	1940.550
352			835.560	880.560	1860.540	1940.580
353			835.590	880.590	1860.570	1940.610
354			835.620	880.620	1860.600	1940.640
355			835.650	880.650	1860.630	1940.670
356			835.680	880.680	1860.660	1940.700
357			835.710	880.710	1860.690	1940.730
358			835.740	880.740	1860.720	1940.760
359			835.770	880.770	1860.750	1940.790
360			835.800	880.800	1860.780	1940.820

Table B-1 NADC/NAMPS Cellular Channel Numbers and Frequencies (cont)

CHANNEL NUMBER	BAND					
	NADC-U4		NADC-U8		NADC-HY	
	MOBILE TRANSMIT (MHz)	MOBILE RECEIVE (MHz)	MOBILE TRANSMIT (MHz)	MOBILE RECEIVE (MHz)	MOBILE TRANSMIT (MHz)	MOBILE RECEIVE (MHz)
361			835.830	880.830	1860.810	1940.850
362			835.860	880.860	1860.840	1940.880
363			835.890	880.890	1860.870	1940.910
364			835.920	880.920	1860.900	1940.940
365			835.950	880.950	1860.930	1940.970
366			835.980	880.980	1860.960	1941.000
367			836.010	881.010	1860.990	1941.030
368			836.040	881.040	1861.020	1941.060
369			836.070	881.070	1861.050	1941.090
370			836.100	881.100	1861.080	1941.120
371			836.130	881.130	1861.110	1941.150
372			836.160	881.160	1861.140	1941.180
373			836.190	881.190	1861.170	1941.210
374			836.220	881.220	1861.200	1941.240
375			836.250	881.250	1861.230	1941.270
376			836.280	881.280	1861.260	1941.300
377			836.310	881.310	1861.290	1941.330
378			836.340	881.340	1861.320	1941.360
379			836.370	881.370	1861.350	1941.390
380			836.400	881.400	1861.380	1941.420
381			836.430	881.430	1861.410	1941.450
382			836.460	881.460	1861.440	1941.480
383			836.490	881.490	1861.470	1941.510
384			836.520	881.520	1861.500	1941.540
385			836.550	881.550	1861.530	1941.570
386			836.580	881.580	1861.560	1941.600
387			836.610	881.610	1861.590	1941.630
388			836.640	881.640	1861.620	1941.660
389			836.670	881.670	1861.650	1941.690
390			836.700	881.700	1861.680	1941.720
391			836.730	881.730	1861.710	1941.750
392			836.760	881.760	1861.740	1941.780
393			836.790	881.790	1861.770	1941.810
394			836.820	881.820	1861.800	1941.840
395			836.850	881.850	1861.830	1941.870
396			836.880	881.880	1861.860	1941.900
397			836.910	881.910	1861.890	1941.930
398			836.940	881.940	1861.920	1941.960
399			836.970	881.970	1861.950	1941.990
400			837.000	882.000	1861.980	1942.020

Table B-1 NADC/NAMPS Cellular Channel Numbers and Frequencies (cont)

CHANNEL NUMBER	BAND					
	NADC-U4		NADC-U8		NADC-HY	
	MOBILE TRANSMIT (MHz)	MOBILE RECEIVE (MHz)	MOBILE TRANSMIT (MHz)	MOBILE RECEIVE (MHz)	MOBILE TRANSMIT (MHz)	MOBILE RECEIVE (MHz)
401			837.030	882.030	1862.010	1942.050
402			837.060	882.060	1862.040	1942.080
403			837.090	882.090	1862.070	1942.110
404			837.120	882.120	1862.100	1942.140
405			837.150	882.150	1862.130	1942.170
406			837.180	882.180	1862.160	1942.200
407			837.210	882.210	1862.190	1942.230
408			837.240	882.240	1862.220	1942.260
409			837.270	882.270	1862.250	1942.290
410			837.300	882.300	1862.280	1942.320
411			837.330	882.330	1862.310	1942.350
412			837.360	882.360	1862.340	1942.380
413			837.390	882.390	1862.370	1942.410
414			837.420	882.420	1862.400	1942.440
415			837.450	882.450	1862.430	1942.470
416			837.480	882.480	1862.460	1942.500
417			837.510	882.510	1862.490	1942.530
418			837.540	882.540	1862.520	1942.560
419			837.570	882.570	1862.550	1942.590
420			837.600	882.600	1862.580	1942.620
421			837.630	882.630	1862.610	1942.650
422			837.660	882.660	1862.640	1942.680
423			837.690	882.690	1862.670	1942.710
424			837.720	882.720	1862.700	1942.740
425			837.750	882.750	1862.730	1942.770
426			837.780	882.780	1862.760	1942.800
427			837.810	882.810	1862.790	1942.830
428			837.840	882.840	1862.820	1942.860
429			837.870	882.870	1862.850	1942.890
430			837.900	882.900	1862.880	1942.920
431			837.930	882.930	1862.910	1942.950
432			837.960	882.960	1862.940	1942.980
433			837.990	882.990	1862.970	1943.010
434			838.020	883.020	1863.000	1943.040
435			838.050	883.050	1863.030	1943.070
436			838.080	883.080	1863.060	1943.100
437			838.110	883.110	1863.090	1943.130
438			838.140	883.140	1863.120	1943.160
439			838.170	883.170	1863.150	1943.190
440			838.200	883.200	1863.180	1943.220

Table B-1 NADC/NAMPS Cellular Channel Numbers and Frequencies (cont)

CHANNEL NUMBER	BAND					
	NADC-U4		NADC-U8		NADC-HY	
	MOBILE TRANSMIT (MHz)	MOBILE RECEIVE (MHz)	MOBILE TRANSMIT (MHz)	MOBILE RECEIVE (MHz)	MOBILE TRANSMIT (MHz)	MOBILE RECEIVE (MHz)
441			838.230	883.230	1863.210	1943.250
442			838.260	883.260	1863.240	1943.280
443			838.290	883.290	1863.270	1943.310
444			838.320	883.320	1863.300	1943.340
445			838.350	883.350	1863.330	1943.370
446			838.380	883.380	1863.360	1943.400
447			838.410	883.410	1863.390	1943.430
448			838.440	883.440	1863.420	1943.460
449			838.470	883.470	1863.450	1943.490
450			838.500	883.500	1863.480	1943.520
451			838.530	883.530	1863.510	1943.550
452			838.560	883.560	1863.540	1943.580
453			838.590	883.590	1863.570	1943.610
454			838.620	883.620	1863.600	1943.640
455			838.650	883.650	1863.630	1943.670
456			838.680	883.680	1863.660	1943.700
457			838.710	883.710	1863.690	1943.730
458			838.740	883.740	1863.720	1943.760
459			838.770	883.770	1863.750	1943.790
460			838.800	883.800	1863.780	1943.820
461			838.830	883.830	1863.810	1943.850
462			838.860	883.860	1863.840	1943.880
463			838.890	883.890	1863.870	1943.910
464			838.920	883.920	1863.900	1943.940
465			838.950	883.950	1863.930	1943.970
466			838.980	883.980	1863.960	1944.000
467			839.010	884.010	1863.990	1944.030
468			839.040	884.040	1864.020	1944.060
469			839.070	884.070	1864.050	1944.090
470			839.100	884.100	1864.080	1944.120
471			839.130	884.130	1864.110	1944.150
472			839.160	884.160	1864.140	1944.180
473			839.190	884.190	1864.170	1944.210
474			839.220	884.220	1864.200	1944.240
475			839.250	884.250	1864.230	1944.270
476			839.280	884.280	1864.260	1944.300
477			839.310	884.310	1864.290	1944.330
478			839.340	884.340	1864.320	1944.360
479			839.370	884.370	1864.350	1944.390
480			839.400	884.400	1864.380	1944.420

Table B-1 NADC/NAMPS Cellular Channel Numbers and Frequencies (cont)

CHANNEL NUMBER	BAND					
	NADC-U4		NADC-U8		NADC-HY	
	MOBILE TRANSMIT (MHz)	MOBILE RECEIVE (MHz)	MOBILE TRANSMIT (MHz)	MOBILE RECEIVE (MHz)	MOBILE TRANSMIT (MHz)	MOBILE RECEIVE (MHz)
481			839.430	884.430	1864.410	1944.450
482			839.460	884.460	1864.440	1944.480
483			839.490	884.490	1864.470	1944.510
484			839.520	884.520	1864.500	1944.540
485			839.550	884.550	1864.530	1944.570
486			839.580	884.580	1864.560	1944.600
487			839.610	884.610	1864.590	1944.630
488			839.640	884.640	1864.620	1944.660
489			839.670	884.670	1864.650	1944.690
490			839.700	884.700	1864.680	1944.720
491			839.730	884.730	1864.710	1944.750
492			839.760	884.760	1864.740	1944.780
493			839.790	884.790	1864.770	1944.810
494			839.820	884.820	1864.800	1944.840
495			839.850	884.850	1864.830	1944.870
496			839.880	884.880	1864.860	1944.900
497			839.910	884.910	1864.890	1944.930
498			839.940	884.940	1864.920	1944.960
499			839.970	884.970	1864.950	1944.990
500			840.000	885.000	1864.980	1945.020
501			840.030	885.030	1865.010	1945.050
502			840.060	885.060	1865.040	1945.080
503			840.090	885.090	1865.070	1945.110
504			840.120	885.120	1865.100	1945.140
505			840.150	885.150	1865.130	1945.170
506			840.180	885.180	1865.160	1945.200
507			840.210	885.210	1865.190	1945.230
508			840.240	885.240	1865.220	1945.260
509			840.270	885.270	1865.250	1945.290
510			840.300	885.300	1865.280	1945.320
511			840.330	885.330	1865.310	1945.350
512			840.360	885.360	1865.340	1945.380
513			840.390	885.390	1865.370	1945.410
514			840.420	885.420	1865.400	1945.440
515			840.450	885.450	1865.430	1945.470
516			840.480	885.480	1865.460	1945.500
517			840.510	885.510	1865.490	1945.530
518			840.540	885.540	1865.520	1945.560
519			840.570	885.570	1865.550	1945.590
520			840.600	885.600	1865.580	1945.620

Table B-1 NADC/NAMPS Cellular Channel Numbers and Frequencies (cont)



CHANNEL NUMBER	BAND					
	NADC-U4		NADC-U8		NADC-HY	
	MOBILE TRANSMIT (MHz)	MOBILE RECEIVE (MHz)	MOBILE TRANSMIT (MHz)	MOBILE RECEIVE (MHz)	MOBILE TRANSMIT (MHz)	MOBILE RECEIVE (MHz)
521			840.630	885.630	1865.610	1945.650
522			840.660	885.660	1865.640	1945.680
523			840.690	885.690	1865.670	1945.710
524			840.720	885.720	1865.700	1945.740
525			840.750	885.750	1865.730	1945.770
526			840.780	885.780	1865.760	1945.800
527			840.810	885.810	1865.790	1945.830
528			840.840	885.840	1865.820	1945.860
529			840.870	885.870	1865.850	1945.890
530			840.900	885.900	1865.880	1945.920
531			840.930	885.930	1865.910	1945.950
532			840.960	885.960	1865.940	1945.980
533			840.990	885.990	1865.970	1946.010
534			841.020	886.020	1866.000	1946.040
535			841.050	886.050	1866.030	1946.070
536			841.080	886.080	1866.060	1946.100
537			841.110	886.110	1866.090	1946.130
538			841.140	886.140	1866.120	1946.160
539			841.170	886.170	1866.150	1946.190
540			841.200	886.200	1866.180	1946.220
541			841.230	886.230	1866.210	1946.250
542			841.260	886.260	1866.240	1946.280
543			841.290	886.290	1866.270	1946.310
544			841.320	886.320	1866.300	1946.340
545			841.350	886.350	1866.330	1946.370
546			841.380	886.380	1866.360	1946.400
547			841.410	886.410	1866.390	1946.430
548			841.440	886.440	1866.420	1946.460
549			841.470	886.470	1866.450	1946.490
550			841.500	886.500	1866.480	1946.520
551			841.530	886.530	1866.510	1946.550
552			841.560	886.560	1866.540	1946.580
553			841.590	886.590	1866.570	1946.610
554			841.620	886.620	1866.600	1946.640
555			841.650	886.650	1866.630	1946.670
556			841.680	886.680	1866.660	1946.700
557			841.710	886.710	1866.690	1946.730
558			841.740	886.740	1866.720	1946.760
559			841.770	886.770	1866.750	1946.790
560			841.800	886.800	1866.780	1946.820

Table B-1 NADC/NAMPS Cellular Channel Numbers and Frequencies (cont)

CHANNEL NUMBER	BAND					
	NADC-U4		NADC-U8		NADC-HY	
	MOBILE TRANSMIT (MHz)	MOBILE RECEIVE (MHz)	MOBILE TRANSMIT (MHz)	MOBILE RECEIVE (MHz)	MOBILE TRANSMIT (MHz)	MOBILE RECEIVE (MHz)
561			841.830	886.830	1866.810	1946.850
562			841.860	886.860	1866.840	1946.880
563			841.890	886.890	1866.870	1946.910
564			841.920	886.920	1866.900	1946.940
565			841.950	886.950	1866.930	1946.970
566			841.980	886.980	1866.960	1947.000
567			842.010	887.010	1866.990	1947.030
568			842.040	887.040	1867.020	1947.060
569			842.070	887.070	1867.050	1947.090
570			842.100	887.100	1867.080	1947.120
571			842.130	887.130	1867.110	1947.150
572			842.160	887.160	1867.140	1947.180
573			842.190	887.190	1867.170	1947.210
574			842.220	887.220	1867.200	1947.240
575			842.250	887.250	1867.230	1947.270
576			842.280	887.280	1867.260	1947.300
577			842.310	887.310	1867.290	1947.330
578			842.340	887.340	1867.320	1947.360
579			842.370	887.370	1867.350	1947.390
580			842.400	887.400	1867.380	1947.420
581			842.430	887.430	1867.410	1947.450
582			842.460	887.460	1867.440	1947.480
583			842.490	887.490	1867.470	1947.510
584			842.520	887.520	1867.500	1947.540
585			842.550	887.550	1867.530	1947.570
586			842.580	887.580	1867.560	1947.600
587			842.610	887.610	1867.590	1947.630
588			842.640	887.640	1867.620	1947.660
589			842.670	887.670	1867.650	1947.690
590			842.700	887.700	1867.680	1947.720
591			842.730	887.730	1867.710	1947.750
592			842.760	887.760	1867.740	1947.780
593			842.790	887.790	1867.770	1947.810
594			842.820	887.820	1867.800	1947.840
595			842.850	887.850	1867.830	1947.870
596			842.880	887.880	1867.860	1947.900
597			842.910	887.910	1867.890	1947.930
598			842.940	887.940	1867.920	1947.960
599			842.970	887.970	1867.950	1947.990
600			843.000	888.000	1867.980	1948.020

Table B-1 NADC/NAMPS Cellular Channel Numbers and Frequencies (cont)

CHANNEL NUMBER	BAND					
	NADC-U4		NADC-U8		NADC-HY	
	MOBILE TRANSMIT (MHz)	MOBILE RECEIVE (MHz)	MOBILE TRANSMIT (MHz)	MOBILE RECEIVE (MHz)	MOBILE TRANSMIT (MHz)	MOBILE RECEIVE (MHz)
601			843.030	888.030	1868.010	1948.050
602			843.060	888.060	1868.040	1948.080
603			843.090	888.090	1868.070	1948.110
604			843.120	888.120	1868.100	1948.140
605			843.150	888.150	1868.130	1948.170
606			843.180	888.180	1868.160	1948.200
607			843.210	888.210	1868.190	1948.230
608			843.240	888.240	1868.220	1948.260
609			843.270	888.270	1868.250	1948.290
610			843.300	888.300	1868.280	1948.320
611			843.330	888.330	1868.310	1948.350
612			843.360	888.360	1868.340	1948.380
613			843.390	888.390	1868.370	1948.410
614			843.420	888.420	1868.400	1948.440
615			843.450	888.450	1868.430	1948.470
616			843.480	888.480	1868.460	1948.500
617			843.510	888.510	1868.490	1948.530
618			843.540	888.540	1868.520	1948.560
619			843.570	888.570	1868.550	1948.590
620			843.600	888.600	1868.580	1948.620
621			843.630	888.630	1868.610	1948.650
622			843.660	888.660	1868.640	1948.680
623			843.690	888.690	1868.670	1948.710
624			843.720	888.720	1868.700	1948.740
625			843.750	888.750	1868.730	1948.770
626			843.780	888.780	1868.760	1948.800
627			843.810	888.810	1868.790	1948.830
628			843.840	888.840	1868.820	1948.860
629			843.870	888.870	1868.850	1948.890
630			843.900	888.900	1868.880	1948.920
631			843.930	888.930	1868.910	1948.950
632			843.960	888.960	1868.940	1948.980
633			843.990	888.990	1868.970	1949.010
634			844.020	889.020	1869.000	1949.040
635			844.050	889.050	1869.030	1949.070
636			844.080	889.080	1869.060	1949.100
637			844.110	889.110	1869.090	1949.130
638			844.140	889.140	1869.120	1949.160
639			844.170	889.170	1869.150	1949.190
640			844.200	889.200	1869.180	1949.220

Table B-1 NADC/NAMPS Cellular Channel Numbers and Frequencies (cont)

CHANNEL NUMBER	BAND					
	NADC-U4		NADC-U8		NADC-HY	
	MOBILE TRANSMIT (MHz)	MOBILE RECEIVE (MHz)	MOBILE TRANSMIT (MHz)	MOBILE RECEIVE (MHz)	MOBILE TRANSMIT (MHz)	MOBILE RECEIVE (MHz)
641			844.230	889.230	1869.210	1949.250
642			844.260	889.260	1869.240	1949.280
643			844.290	889.290	1869.270	1949.310
644			844.320	889.320	1869.300	1949.340
645			844.350	889.350	1869.330	1949.370
646			844.380	889.380	1869.360	1949.400
647			844.410	889.410	1869.390	1949.430
648			844.440	889.440	1869.420	1949.460
649			844.470	889.470	1869.450	1949.490
650			844.500	889.500	1869.480	1949.520
651			844.530	889.530	1869.510	1949.550
652			844.560	889.560	1869.540	1949.580
653			844.590	889.590	1869.570	1949.610
654			844.620	889.620	1869.600	1949.640
655			844.650	889.650	1869.630	1949.670
656			844.680	889.680	1869.660	1949.700
657			844.710	889.710	1869.690	1949.730
658			844.740	889.740	1869.720	1949.760
659			844.770	889.770	1869.750	1949.790
660			844.800	889.800	1869.780	1949.820
661			844.830	889.830	1869.810	1949.850
662			844.860	889.860	1869.840	1949.880
663			844.890	889.890	1869.870	1949.910
664			844.920	889.920	1869.900	1949.940
665			844.950	889.950	1869.930	1949.970
666			844.980	889.980	1869.960	1950.000
667			845.010	890.010	1869.990	1950.030
668			845.040	890.040	1870.020	1950.060
669			845.070	890.070	1870.050	1950.090
670			845.100	890.100	1870.080	1950.120
671			845.130	890.130	1870.110	1950.150
672			845.160	890.160	1870.140	1950.180
673			845.190	890.190	1870.170	1950.210
674			845.220	890.220	1870.200	1950.240
675			845.250	890.250	1870.230	1950.270
676			845.280	890.280	1870.260	1950.300
677			845.310	890.310	1870.290	1950.330
678			845.340	890.340	1870.320	1950.360
679			845.370	890.370	1870.350	1950.390
680			845.400	890.400	1870.380	1950.420

Table B-1 NADC/NAMPS Cellular Channel Numbers and Frequencies (cont)

CHANNEL NUMBER	BAND					
	NADC-U4		NADC-U8		NADC-HY	
	MOBILE TRANSMIT (MHz)	MOBILE RECEIVE (MHz)	MOBILE TRANSMIT (MHz)	MOBILE RECEIVE (MHz)	MOBILE TRANSMIT (MHz)	MOBILE RECEIVE (MHz)
681			845.430	890.430	1870.410	1950.450
682			845.460	890.460	1870.440	1950.480
683			845.490	890.490	1870.470	1950.510
684			845.520	890.520	1870.500	1950.540
685			845.550	890.550	1870.530	1950.570
686			845.580	890.580	1870.560	1950.600
687			845.610	890.610	1870.590	1950.630
688			845.640	890.640	1870.620	1950.660
689			845.670	890.670	1870.650	1950.690
690			845.700	890.700	1870.680	1950.720
691			845.730	890.730	1870.710	1950.750
692			845.760	890.760	1870.740	1950.780
693			845.790	890.790	1870.770	1950.810
694			845.820	890.820	1870.800	1950.840
695			845.850	890.850	1870.830	1950.870
696			845.880	890.880	1870.860	1950.900
697			845.910	890.910	1870.890	1950.930
698			845.940	890.940	1870.920	1950.960
699			845.970	890.970	1870.950	1950.990
700			846.000	891.000	1870.980	1951.020
701			846.030	891.030	1871.010	1951.050
702			846.060	891.060	1871.040	1951.080
703			846.090	891.090	1871.070	1951.110
704			846.120	891.120	1871.100	1951.140
705			846.150	891.150	1871.130	1951.170
706			846.180	891.180	1871.160	1951.200
707			846.210	891.210	1871.190	1951.230
708			846.240	891.240	1871.220	1951.260
709			846.270	891.270	1871.250	1951.290
710			846.300	891.300	1871.280	1951.320
711			846.330	891.330	1871.310	1951.350
712			846.360	891.360	1871.340	1951.380
713			846.390	891.390	1871.370	1951.410
714			846.420	891.420	1871.400	1951.440
715			846.450	891.450	1871.430	1951.470
716			846.480	891.480	1871.460	1951.500
717			846.510	891.510	1871.490	1951.530
718			846.540	891.540	1871.520	1951.560
719			846.570	891.570	1871.550	1951.590
720			846.600	891.600	1871.580	1951.620

Table B-1 NADC/NAMPS Cellular Channel Numbers and Frequencies (cont)

CHANNEL NUMBER	BAND					
	NADC-U4		NADC-U8		NADC-HY	
	MOBILE TRANSMIT (MHz)	MOBILE RECEIVE (MHz)	MOBILE TRANSMIT (MHz)	MOBILE RECEIVE (MHz)	MOBILE TRANSMIT (MHz)	MOBILE RECEIVE (MHz)
721			846.630	891.630	1871.610	1951.650
722			846.660	891.660	1871.640	1951.680
723			846.690	891.690	1871.670	1951.710
724			846.720	891.720	1871.700	1951.740
725			846.750	891.750	1871.730	1951.770
726			846.780	891.780	1871.760	1951.800
727			846.810	891.810	1871.790	1951.830
728			846.840	891.840	1871.820	1951.860
729			846.870	891.870	1871.850	1951.890
730			846.900	891.900	1871.880	1951.920
731			846.930	891.930	1871.910	1951.950
732			846.960	891.960	1871.940	1951.980
733			846.990	891.990	1871.970	1952.010
734			847.020	892.020	1872.000	1952.040
735			847.050	892.050	1872.030	1952.070
736			847.080	892.080	1872.060	1952.100
737			847.110	892.110	1872.090	1952.130
738			847.140	892.140	1872.120	1952.160
739			847.170	892.170	1872.150	1952.190
740			847.200	892.200	1872.180	1952.220
741			847.230	892.230	1872.210	1952.250
742			847.260	892.260	1872.240	1952.280
743			847.290	892.290	1872.270	1952.310
744			847.320	892.320	1872.300	1952.340
745			847.350	892.350	1872.330	1952.370
746			847.380	892.380	1872.360	1952.400
747			847.410	892.410	1872.390	1952.430
748			847.440	892.440	1872.420	1952.460
749			847.470	892.470	1872.450	1952.490
750			847.500	892.500	1872.480	1952.520
751			847.530	892.530	1872.510	1952.550
752			847.560	892.560	1872.540	1952.580
753			847.590	892.590	1872.570	1952.610
754			847.620	892.620	1872.600	1952.640
755			847.650	892.650	1872.630	1952.670
756			847.680	892.680	1872.660	1952.700
757			847.710	892.710	1872.690	1952.730
758			847.740	892.740	1872.720	1952.760
759			847.770	892.770	1872.750	1952.790
760			847.800	892.800	1872.780	1952.820

Table B-1 NADC/NAMPS Cellular Channel Numbers and Frequencies (cont)

CHANNEL NUMBER	BAND					
	NADC-U4		NADC-U8		NADC-HY	
	MOBILE TRANSMIT (MHz)	MOBILE RECEIVE (MHz)	MOBILE TRANSMIT (MHz)	MOBILE RECEIVE (MHz)	MOBILE TRANSMIT (MHz)	MOBILE RECEIVE (MHz)
761			847.830	892.830	1872.810	1952.850
762			847.860	892.860	1872.840	1952.880
763			847.890	892.890	1872.870	1952.910
764			847.920	892.920	1872.900	1952.940
765			847.950	892.950	1872.930	1952.970
766			847.980	892.980	1872.960	1953.000
767			848.010	893.010	1872.990	1953.030
768			848.040	893.040	1873.020	1953.060
769			848.070	893.070	1873.050	1953.090
770			848.100	893.100	1873.080	1953.120
771			848.130	893.130	1873.110	1953.150
772			848.160	893.160	1873.140	1953.180
773			848.190	893.190	1873.170	1953.210
774			848.220	893.220	1873.200	1953.240
775			848.250	893.250	1873.230	1953.270
776			848.280	893.280	1873.260	1953.300
777			848.310	893.310	1873.290	1953.330
778			848.340	893.340	1873.320	1953.360
779			848.370	893.370	1873.350	1953.390
780			848.400	893.400	1873.380	1953.420
781			848.430	893.430	1873.410	1953.450
782			848.460	893.460	1873.440	1953.480
783			848.490	893.490	1873.470	1953.510
784			848.520	893.520	1873.500	1953.540
785			848.550	893.550	1873.530	1953.570
786			848.580	893.580	1873.560	1953.600
787			848.610	893.610	1873.590	1953.630
788			848.640	893.640	1873.620	1953.660
789			848.670	893.670	1873.650	1953.690
790			848.700	893.700	1873.680	1953.720
791			848.730	893.730	1873.710	1953.750
792			848.760	893.760	1873.740	1953.780
793			848.790	893.790	1873.770	1953.810
794			848.820	893.820	1873.800	1953.840
795			848.850	893.850	1873.830	1953.870
796			848.880	893.880	1873.860	1953.900
797			848.910	893.910	1873.890	1953.930
798			848.940	893.940	1873.920	1953.960
799			848.970	893.970	1873.950	1953.990
800 <sup>1</sup>			849.000	894.000	1873.980	1954.020

Table B-1 NADC/NAMPS Cellular Channel Numbers and Frequencies (cont)

CHANNEL NUMBER	BAND					
	NADC-U4		NADC-U8		NADC-HY	
	MOBILE TRANSMIT (MHz)	MOBILE RECEIVE (MHz)	MOBILE TRANSMIT (MHz)	MOBILE RECEIVE (MHz)	MOBILE TRANSMIT (MHz)	MOBILE RECEIVE (MHz)
801 <sup>1</sup>			849.030	894.030	1874.010	1954.050
802 <sup>1</sup>			849.060	894.060	1874.040	1954.080
803 <sup>1</sup>			849.090	894.090	1874.070	1954.110
804 <sup>1</sup>			849.120	894.120	1874.100	1954.140
805 <sup>1</sup>			849.150	894.150	1874.130	1954.170
806 <sup>1</sup>			849.180	894.180	1874.160	1954.200
807 <sup>1</sup>			849.210	894.210	1874.190	1954.230
808 <sup>1</sup>			849.240	894.240	1874.220	1954.260
809 <sup>1</sup>			849.270	894.270	1874.250	1954.290
810 <sup>1</sup>			849.300	894.300	1874.280	1954.320
811 <sup>1</sup>			849.330	894.330	1874.310	1954.350
812 <sup>1</sup>			849.360	894.360	1874.340	1954.380
813 <sup>1</sup>			849.390	894.390	1874.370	1954.410
814 <sup>1</sup>			849.420	894.420	1874.400	1954.440
815 <sup>1</sup>			849.450	894.450	1874.430	1954.470
816 <sup>1</sup>			849.480	894.480	1874.460	1954.500
817 <sup>1</sup>			849.510	894.510	1874.490	1954.530
818 <sup>1</sup>			849.540	894.540	1874.520	1954.560
819 <sup>1</sup>			849.570	894.570	1874.550	1954.590
820 <sup>1</sup>			849.600	894.600	1874.580	1954.620
821 <sup>1</sup>			849.630	894.630	1874.610	1954.650
822 <sup>1</sup>			849.660	894.660	1874.640	1954.680
823 <sup>1</sup>			849.690	894.690	1874.670	1954.710
824 <sup>1</sup>			849.720	894.720	1874.700	1954.740
825 <sup>1</sup>			849.750	894.750	1874.730	1954.770
826 <sup>1</sup>			849.780	894.780	1874.760	1954.800
827 <sup>1</sup>			849.810	894.810	1874.790	1954.830
828 <sup>1</sup>			849.840	894.840	1874.820	1954.860
829 <sup>1</sup>			849.870	894.870	1874.850	1954.890
830 <sup>1</sup>			849.900	894.900	1874.880	1954.920
831 <sup>1</sup>			849.930	894.930	1874.910	1954.950
832 <sup>1</sup>			849.960	894.960	1874.940	1954.980
833 <sup>1</sup>			849.990	894.990	1874.970	1955.010
834 <sup>1</sup>			850.020	895.020	1875.000	1955.040
835 <sup>1</sup>			850.050	895.050	1875.030	1955.070
836 <sup>1</sup>			850.080	895.080	1875.060	1955.100
837 <sup>1</sup>			850.110	895.110	1875.090	1955.130
838 <sup>1</sup>			850.140	895.140	1875.120	1955.160
839 <sup>1</sup>			850.170	895.170	1875.150	1955.190
840 <sup>1</sup>			850.200	895.200	1875.180	1955.220

Table B-1 NADC/NAMPS Cellular Channel Numbers and Frequencies (cont)



CHANNEL NUMBER	BAND					
	NADC-U4		NADC-U8		NADC-HY	
	MOBILE TRANSMIT (MHz)	MOBILE RECEIVE (MHz)	MOBILE TRANSMIT (MHz)	MOBILE RECEIVE (MHz)	MOBILE TRANSMIT (MHz)	MOBILE RECEIVE (MHz)
841 <sup>1</sup>			850.230	895.230	1875.210	1955.250
842 <sup>1</sup>			850.260	895.260	1875.240	1955.280
843 <sup>1</sup>			850.290	895.290	1875.270	1955.310
844 <sup>1</sup>			850.320	895.320	1875.300	1955.340
845 <sup>1</sup>			850.350	895.350	1875.330	1955.370
846 <sup>1</sup>			850.380	895.380	1875.360	1955.400
847 <sup>1</sup>			850.410	895.410	1875.390	1955.430
848 <sup>1</sup>			850.440	895.440	1875.420	1955.460
849 <sup>1</sup>			850.470	895.470	1875.450	1955.490
850 <sup>1</sup>			850.500	895.500	1875.480	1955.520
851 <sup>1</sup>			850.530	895.530	1875.510	1955.550
852 <sup>1</sup>			850.560	895.560	1875.540	1955.580
853 <sup>1</sup>			850.590	895.590	1875.570	1955.610
854 <sup>1</sup>			850.620	895.620	1875.600	1955.640
855 <sup>1</sup>			850.650	895.650	1875.630	1955.670
856 <sup>1</sup>			850.680	895.680	1875.660	1955.700
857 <sup>1</sup>			850.710	895.710	1875.690	1955.730
858 <sup>1</sup>			850.740	895.740	1875.720	1955.760
859 <sup>1</sup>			850.770	895.770	1875.750	1955.790
860 <sup>1</sup>			850.800	895.800	1875.780	1955.820
861 <sup>1</sup>			850.830	895.830	1875.810	1955.850
862 <sup>1</sup>			850.860	895.860	1875.840	1955.880
863 <sup>1</sup>			850.890	895.890	1875.870	1955.910
864 <sup>1</sup>			850.920	895.920	1875.900	1955.940
865 <sup>1</sup>			850.950	895.950	1875.930	1955.970
866 <sup>1</sup>			850.980	895.980	1875.960	1956.000
867 <sup>2</sup>			851.010	896.010	1875.990	1956.030
868 <sup>2</sup>			851.040	896.040	1876.020	1956.060
869 <sup>2</sup>			851.070	896.070	1876.050	1956.090
870 <sup>2</sup>			851.100	896.100	1876.080	1956.120
871 <sup>2</sup>			851.130	896.130	1876.110	1956.150
872 <sup>2</sup>			851.160	896.160	1876.140	1956.180
873 <sup>2</sup>			851.190	896.190	1876.170	1956.210
874 <sup>2</sup>			851.220	896.220	1876.200	1956.240
875 <sup>2</sup>			851.250	896.250	1876.230	1956.270
876 <sup>2</sup>			851.280	896.280	1876.260	1956.300
877 <sup>2</sup>			851.310	896.310	1876.290	1956.330
878 <sup>2</sup>			851.340	896.340	1876.320	1956.360
879 <sup>2</sup>			851.370	896.370	1876.350	1956.390
880 <sup>2</sup>			851.400	896.400	1876.380	1956.420

Table B-1 NADC/NAMPS Cellular Channel Numbers and Frequencies (cont)

CHANNEL NUMBER	BAND					
	NADC-U4		NADC-U8		NADC-HY	
	MOBILE TRANSMIT (MHz)	MOBILE RECEIVE (MHz)	MOBILE TRANSMIT (MHz)	MOBILE RECEIVE (MHz)	MOBILE TRANSMIT (MHz)	MOBILE RECEIVE (MHz)
881 <sup>2</sup>			851.430	896.430	1876.410	1956.450
882 <sup>2</sup>			851.460	896.460	1876.440	1956.480
883 <sup>2</sup>			851.490	896.490	1876.470	1956.510
884 <sup>2</sup>			851.520	896.520	1876.500	1956.540
885 <sup>2</sup>			851.550	896.550	1876.530	1956.570
886 <sup>2</sup>			851.580	896.580	1876.560	1956.600
887 <sup>2</sup>			851.610	896.610	1876.590	1956.630
888 <sup>2</sup>			851.640	896.640	1876.620	1956.660
889 <sup>2</sup>			851.670	896.670	1876.650	1956.690
890 <sup>2</sup>			851.700	896.700	1876.680	1956.720
891 <sup>2</sup>			851.730	896.730	1876.710	1956.750
892 <sup>2</sup>			851.760	896.760	1876.740	1956.780
893 <sup>2</sup>			851.790	896.790	1876.770	1956.810
894 <sup>2</sup>			851.820	896.820	1876.800	1956.840
895 <sup>2</sup>			851.850	896.850	1876.830	1956.870
896 <sup>2</sup>			851.880	896.880	1876.860	1956.900
897 <sup>2</sup>			851.910	896.910	1876.890	1956.930
898 <sup>2</sup>			851.940	896.940	1876.920	1956.960
899 <sup>2</sup>			851.970	896.970	1876.950	1956.990
900 <sup>2</sup>			852.000	897.000	1876.980	1957.020
901 <sup>2</sup>			852.030	897.030	1877.010	1957.050
902 <sup>2</sup>			852.060	897.060	1877.040	1957.080
903 <sup>2</sup>			852.090	897.090	1877.070	1957.110
904 <sup>2</sup>			852.120	897.120	1877.100	1957.140
905 <sup>2</sup>			852.150	897.150	1877.130	1957.170
906 <sup>2</sup>			852.180	897.180	1877.160	1957.200
907 <sup>2</sup>			852.210	897.210	1877.190	1957.230
908 <sup>2</sup>			852.240	897.240	1877.220	1957.260
909 <sup>2</sup>			852.270	897.270	1877.250	1957.290
910 <sup>2</sup>			852.300	897.300	1877.280	1957.320
911 <sup>2</sup>			852.330	897.330	1877.310	1957.350
912 <sup>2</sup>			852.360	897.360	1877.340	1957.380
913 <sup>2</sup>			852.390	897.390	1877.370	1957.410
914 <sup>2</sup>			852.420	897.420	1877.400	1957.440
915 <sup>2</sup>			852.450	897.450	1877.430	1957.470
916 <sup>2</sup>			852.480	897.480	1877.460	1957.500
917 <sup>2</sup>			852.510	897.510	1877.490	1957.530
918 <sup>2</sup>			852.540	897.540	1877.520	1957.560
919 <sup>2</sup>			852.570	897.570	1877.550	1957.590
920 <sup>2</sup>			852.600	897.600	1877.580	1957.620

Table B-1 NADC/NAMPS Cellular Channel Numbers and Frequencies (cont)

CHANNEL NUMBER	BAND					
	NADC-U4		NADC-U8		NADC-HY	
	MOBILE TRANSMIT (MHz)	MOBILE RECEIVE (MHz)	MOBILE TRANSMIT (MHz)	MOBILE RECEIVE (MHz)	MOBILE TRANSMIT (MHz)	MOBILE RECEIVE (MHz)
921 <sup>2</sup>			852.630	897.630	1877.610	1957.650
922 <sup>2</sup>			852.660	897.660	1877.640	1957.680
923 <sup>2</sup>			852.690	897.690	1877.670	1957.710
924 <sup>2</sup>			852.720	897.720	1877.700	1957.740
925 <sup>2</sup>			852.750	897.750	1877.730	1957.770
926 <sup>2</sup>			852.780	897.780	1877.760	1957.800
927 <sup>2</sup>			852.810	897.810	1877.790	1957.830
928 <sup>2</sup>			852.840	897.840	1877.820	1957.860
929 <sup>2</sup>			852.870	897.870	1877.850	1957.890
930 <sup>2</sup>			852.900	897.900	1877.880	1957.920
931 <sup>2</sup>			852.930	897.930	1877.910	1957.950
932 <sup>2</sup>			852.960	897.960	1877.940	1957.980
933 <sup>2</sup>			852.990	897.990	1877.970	1958.010
934 <sup>2</sup>			853.020	898.020	1878.000	1958.040
935 <sup>2</sup>			853.050	898.050	1878.030	1958.070
936 <sup>2</sup>			853.080	898.080	1878.060	1958.100
937 <sup>2</sup>			853.110	898.110	1878.090	1958.130
938 <sup>2</sup>			853.140	898.140	1878.120	1958.160
939 <sup>2</sup>			853.170	898.170	1878.150	1958.190
940 <sup>2</sup>			853.200	898.200	1878.180	1958.220
941 <sup>2</sup>			853.230	898.230	1878.210	1958.250
942 <sup>2</sup>			853.260	898.260	1878.240	1958.280
943 <sup>2</sup>			853.290	898.290	1878.270	1958.310
944 <sup>2</sup>			853.320	898.320	1878.300	1958.340
945 <sup>2</sup>			853.350	898.350	1878.330	1958.370
946 <sup>2</sup>			853.380	898.380	1878.360	1958.400
947 <sup>2</sup>			853.410	898.410	1878.390	1958.430
948 <sup>2</sup>			853.440	898.440	1878.420	1958.460
949 <sup>2</sup>			853.470	898.470	1878.450	1958.490
950 <sup>2</sup>			853.500	898.500	1878.480	1958.520
951 <sup>2</sup>			853.530	898.530	1878.510	1958.550
952 <sup>2</sup>			853.560	898.560	1878.540	1958.580
953 <sup>2</sup>			853.590	898.590	1878.570	1958.610
954 <sup>2</sup>			853.620	898.620	1878.600	1958.640
955 <sup>2</sup>			853.650	898.650	1878.630	1958.670
956 <sup>2</sup>			853.680	898.680	1878.660	1958.700
957 <sup>2</sup>			853.710	898.710	1878.690	1958.730
958 <sup>2</sup>			853.740	898.740	1878.720	1958.760
959 <sup>2</sup>			853.770	898.770	1878.750	1958.790
960 <sup>2</sup>			853.800	898.800	1878.780	1958.820

Table B-1 NADC/NAMPS Cellular Channel Numbers and Frequencies (cont)

CHANNEL NUMBER	BAND					
	NADC-U4		NADC-U8		NADC-HY	
	MOBILE TRANSMIT (MHz)	MOBILE RECEIVE (MHz)	MOBILE TRANSMIT (MHz)	MOBILE RECEIVE (MHz)	MOBILE TRANSMIT (MHz)	MOBILE RECEIVE (MHz)
961 <sup>2</sup>			853.830	898.830	1878.810	1958.850
962 <sup>2</sup>			853.860	898.860	1878.840	1958.880
963 <sup>2</sup>			853.890	898.890	1878.870	1958.910
964 <sup>2</sup>			853.920	898.920	1878.900	1958.940
965 <sup>2</sup>			853.950	898.950	1878.930	1958.970
966 <sup>2</sup>			853.980	898.980	1878.960	1959.000
967 <sup>2</sup>			854.010	899.010	1878.990	1959.030
968 <sup>2</sup>			854.040	899.040	1879.020	1959.060
969 <sup>2</sup>			854.070	899.070	1879.050	1959.090
970 <sup>2</sup>			854.100	899.100	1879.080	1959.120
971 <sup>2</sup>			854.130	899.130	1879.110	1959.150
972 <sup>2</sup>			854.160	899.160	1879.140	1959.180
973 <sup>2</sup>			854.190	899.190	1879.170	1959.210
974 <sup>2</sup>			854.220	899.220	1879.200	1959.240
975 <sup>2</sup>			854.250	899.250	1879.230	1959.270
976 <sup>2</sup>			854.280	899.280	1879.260	1959.300
977 <sup>2</sup>			854.310	899.310	1879.290	1959.330
978 <sup>2</sup>			854.340	899.340	1879.320	1959.360
979 <sup>2</sup>			854.370	899.370	1879.350	1959.390
980 <sup>2</sup>			854.400	899.400	1879.380	1959.420
981 <sup>2</sup>			854.430	899.430	1879.410	1959.450
982 <sup>2</sup>			854.460	899.460	1879.440	1959.480
983 <sup>2</sup>			854.490	899.490	1879.470	1959.510
984 <sup>2</sup>			854.520	899.520	1879.500	1959.540
985 <sup>2</sup>			854.550	899.550	1879.530	1959.570
986 <sup>2</sup>			854.580	899.580	1879.560	1959.600
987 <sup>2</sup>			854.610	899.610	1879.590	1959.630
988 <sup>2</sup>			854.640	899.640	1879.620	1959.660
989 <sup>2</sup>			854.670	899.670	1879.650	1959.690
990 <sup>3</sup>			824.010	869.010	1879.680	1959.720
991			824.040	869.040	1879.710	1959.750
992			824.070	869.070	1879.740	1959.780
993			824.100	869.100	1879.770	1959.810
994			824.130	869.130	1879.800	1959.840
995			824.160	869.160	1879.830	1959.870
996			824.190	869.190	1879.860	1959.900
997			824.220	869.220	1879.890	1959.930
998			824.250	869.250	1879.920	1959.960
999			824.280	869.280	1879.950	1959.990
1000			824.310	869.310	1879.980	1960.020

Table B-1 NADC/NAMPS Cellular Channel Numbers and Frequencies (cont)

CHANNEL NUMBER	BAND					
	NADC-U4		NADC-U8		NADC-HY	
	MOBILE TRANSMIT (MHz)	MOBILE RECEIVE (MHz)	MOBILE TRANSMIT (MHz)	MOBILE RECEIVE (MHz)	MOBILE TRANSMIT (MHz)	MOBILE RECEIVE (MHz)
1001			824.340	869.340	1880.010	1960.050
1002			824.370	869.370	1880.040	1960.080
1003			824.400	869.400	1880.070	1960.110
1004			824.430	869.430	1880.100	1960.140
1005			824.460	869.460	1880.130	1960.170
1006			824.490	869.490	1880.160	1960.200
1007			824.520	869.520	1880.190	1960.230
1008			824.550	869.550	1880.220	1960.260
1009			824.580	869.580	1880.250	1960.290
1010			824.610	869.610	1880.280	1960.320
1011			824.640	869.640	1880.310	1960.350
1012			824.670	869.670	1880.340	1960.380
1013			824.700	869.700	1880.370	1960.410
1014			824.730	869.730	1880.400	1960.440
1015			824.760	869.760	1880.430	1960.470
1016			824.790	869.790	1880.460	1960.500
1017			824.820	869.820	1880.490	1960.530
1018			824.850	869.850	1880.520	1960.560
1019			824.880	869.880	1880.550	1960.590
1020			824.910	869.910	1880.580	1960.620
1021			824.940	869.940	1880.610	1960.650
1022			824.970	869.970	1880.640	1960.680
1023			825.000	870.000	1880.670	1960.710
1024					1880.700	1960.740
1025					1880.730	1960.770
1026					1880.760	1960.800
1027					1880.790	1960.830
1028					1880.820	1960.860
1029					1880.850	1960.890
1030					1880.880	1960.920
1031					1880.910	1960.950
1032					1880.940	1960.980
1033					1880.970	1961.010
1034					1881.000	1961.040
1035					1881.030	1961.070
1036					1881.060	1961.100
1037					1881.090	1961.130
1038					1881.120	1961.160
1039					1881.150	1961.190
1040					1881.180	1961.220

Table B-1 NADC/NAMPS Cellular Channel Numbers and Frequencies (cont)

CHANNEL NUMBER	BAND					
	NADC-U4		NADC-U8		NADC-HY	
	MOBILE TRANSMIT (MHz)	MOBILE RECEIVE (MHz)	MOBILE TRANSMIT (MHz)	MOBILE RECEIVE (MHz)	MOBILE TRANSMIT (MHz)	MOBILE RECEIVE (MHz)
1041					1881.210	1961.250
1042					1881.240	1961.280
1043					1881.270	1961.310
1044					1881.300	1961.340
1045					1881.330	1961.370
1046					1881.360	1961.400
1047					1881.390	1961.430
1048					1881.420	1961.460
1049					1881.450	1961.490
1050					1881.480	1961.520
1051					1881.510	1961.550
1052					1881.540	1961.580
1053					1881.570	1961.610
1054					1881.600	1961.640
1055					1881.630	1961.670
1056					1881.660	1961.700
1057					1881.690	1961.730
1058					1881.720	1961.760
1059					1881.750	1961.790
1060					1881.780	1961.820
1061					1881.810	1961.850
1062					1881.840	1961.880
1063					1881.870	1961.910
1064					1881.900	1961.940
1065					1881.930	1961.970
1066					1881.960	1962.000
1067					1881.990	1962.030
1068					1882.020	1962.060
1069					1882.050	1962.090
1070					1882.080	1962.120
1071					1882.110	1962.150
1072					1882.140	1962.180
1073					1882.170	1962.210
1074					1882.200	1962.240
1075					1882.230	1962.270
1076					1882.260	1962.300
1077					1882.290	1962.330
1078					1882.320	1962.360
1079					1882.350	1962.390
1080					1882.380	1962.420

Table B-1 NADC/NAMPS Cellular Channel Numbers and Frequencies (cont)

CHANNEL NUMBER	BAND					
	NADC-U4		NADC-U8		NADC-HY	
	MOBILE TRANSMIT (MHz)	MOBILE RECEIVE (MHz)	MOBILE TRANSMIT (MHz)	MOBILE RECEIVE (MHz)	MOBILE TRANSMIT (MHz)	MOBILE RECEIVE (MHz)
1081					1882.410	1962.450
1082					1882.440	1962.480
1083					1882.470	1962.510
1084					1882.500	1962.540
1085					1882.530	1962.570
1086					1882.560	1962.600
1087					1882.590	1962.630
1088					1882.620	1962.660
1089					1882.650	1962.690
1090					1882.680	1962.720
1091					1882.710	1962.750
1092					1882.740	1962.780
1093					1882.770	1962.810
1094					1882.800	1962.840
1095					1882.830	1962.870
1096					1882.860	1962.900
1097					1882.890	1962.930
1098					1882.920	1962.960
1099					1882.950	1962.990
1100					1882.980	1963.020
1101					1883.010	1963.050
1102					1883.040	1963.080
1103					1883.070	1963.110
1104					1883.100	1963.140
1105					1883.130	1963.170
1106					1883.160	1963.200
1107					1883.190	1963.230
1108					1883.220	1963.260
1109					1883.250	1963.290
1110					1883.280	1963.320
1111					1883.310	1963.350
1112					1883.340	1963.380
1113					1883.370	1963.410
1114					1883.400	1963.440
1115					1883.430	1963.470
1116					1883.460	1963.500
1117					1883.490	1963.530
1118					1883.520	1963.560
1119					1883.550	1963.590
1120					1883.580	1963.620

Table B-1 NADC/NAMPS Cellular Channel Numbers and Frequencies (cont)

CHANNEL NUMBER	BAND					
	NADC-U4		NADC-U8		NADC-HY	
	MOBILE TRANSMIT (MHz)	MOBILE RECEIVE (MHz)	MOBILE TRANSMIT (MHz)	MOBILE RECEIVE (MHz)	MOBILE TRANSMIT (MHz)	MOBILE RECEIVE (MHz)
1121					1883.610	1963.650
1122					1883.640	1963.680
1123					1883.670	1963.710
1124					1883.700	1963.740
1125					1883.730	1963.770
1126					1883.760	1963.800
1127					1883.790	1963.830
1128					1883.820	1963.860
1129					1883.850	1963.890
1130					1883.880	1963.920
1131					1883.910	1963.950
1132					1883.940	1963.980
1133					1883.970	1964.010
1134					1884.000	1964.040
1135					1884.030	1964.070
1136					1884.060	1964.100
1137					1884.090	1964.130
1138					1884.120	1964.160
1139					1884.150	1964.190
1140					1884.180	1964.220
1141					1884.210	1964.250
1142					1884.240	1964.280
1143					1884.270	1964.310
1144					1884.300	1964.340
1145					1884.330	1964.370
1146					1884.360	1964.400
1147					1884.390	1964.430
1148					1884.420	1964.460
1149					1884.450	1964.490
1150					1884.480	1964.520
1151					1884.510	1964.550
1152					1884.540	1964.580
1153					1884.570	1964.610
1154					1884.600	1964.640
1155					1884.630	1964.670
1156					1884.660	1964.700
1157					1884.690	1964.730
1158					1884.720	1964.760
1159					1884.750	1964.790
1160					1884.780	1964.820

Table B-1 NADC/NAMPS Cellular Channel Numbers and Frequencies (cont)



CHANNEL NUMBER	BAND					
	NADC-U4		NADC-U8		NADC-HY	
	MOBILE TRANSMIT (MHz)	MOBILE RECEIVE (MHz)	MOBILE TRANSMIT (MHz)	MOBILE RECEIVE (MHz)	MOBILE TRANSMIT (MHz)	MOBILE RECEIVE (MHz)
1161					1884.810	1964.850
1162					1884.840	1964.880
1163					1884.870	1964.910
1164					1884.900	1964.940
1165					1884.930	1964.970
1166					1884.960	1965.000
1167					1884.990	1965.030
1168					1885.020	1965.060
1169					1885.050	1965.090
1170					1885.080	1965.120
1171					1885.110	1965.150
1172					1885.140	1965.180
1173					1885.170	1965.210
1174					1885.200	1965.240
1175					1885.230	1965.270
1176					1885.260	1965.300
1177					1885.290	1965.330
1178					1885.320	1965.360
1179					1885.350	1965.390
1180					1885.380	1965.420
1181					1885.410	1965.450
1182					1885.440	1965.480
1183					1885.470	1965.510
1184					1885.500	1965.540
1185					1885.530	1965.570
1186					1885.560	1965.600
1187					1885.590	1965.630
1188					1885.620	1965.660
1189					1885.650	1965.690
1190					1885.680	1965.720
1191					1885.710	1965.750
1192					1885.740	1965.780
1193					1885.770	1965.810
1194					1885.800	1965.840
1195					1885.830	1965.870
1196					1885.860	1965.900
1197					1885.890	1965.930
1198					1885.920	1965.960
1199					1885.950	1965.990
1200					1885.980	1966.020

Table B-1 NADC/NAMPS Cellular Channel Numbers and Frequencies (cont)

CHANNEL NUMBER	BAND					
	NADC-U4		NADC-U8		NADC-HY	
	MOBILE TRANSMIT (MHz)	MOBILE RECEIVE (MHz)	MOBILE TRANSMIT (MHz)	MOBILE RECEIVE (MHz)	MOBILE TRANSMIT (MHz)	MOBILE RECEIVE (MHz)
1201					1886.010	1966.050
1202					1886.040	1966.080
1203					1886.070	1966.110
1204					1886.100	1966.140
1205					1886.130	1966.170
1206					1886.160	1966.200
1207					1886.190	1966.230
1208					1886.220	1966.260
1209					1886.250	1966.290
1210					1886.280	1966.320
1211					1886.310	1966.350
1212					1886.340	1966.380
1213					1886.370	1966.410
1214					1886.400	1966.440
1215					1886.430	1966.470
1216					1886.460	1966.500
1217					1886.490	1966.530
1218					1886.520	1966.560
1219					1886.550	1966.590
1220					1886.580	1966.620
1221					1886.610	1966.650
1222					1886.640	1966.680
1223					1886.670	1966.710
1224					1886.700	1966.740
1225					1886.730	1966.770
1226					1886.760	1966.800
1227					1886.790	1966.830
1228					1886.820	1966.860
1229					1886.850	1966.890
1230					1886.880	1966.920
1231					1886.910	1966.950
1232					1886.940	1966.980
1233					1886.970	1967.010
1234					1887.000	1967.040
1235					1887.030	1967.070
1236					1887.060	1967.100
1237					1887.090	1967.130
1238					1887.120	1967.160
1239					1887.150	1967.190
1240					1887.180	1967.220

Table B-1 NADC/NAMPS Cellular Channel Numbers and Frequencies (cont)

CHANNEL NUMBER	BAND					
	NADC-U4		NADC-U8		NADC-HY	
	MOBILE TRANSMIT (MHz)	MOBILE RECEIVE (MHz)	MOBILE TRANSMIT (MHz)	MOBILE RECEIVE (MHz)	MOBILE TRANSMIT (MHz)	MOBILE RECEIVE (MHz)
1241					1887.210	1967.250
1242					1887.240	1967.280
1243					1887.270	1967.310
1244					1887.300	1967.340
1245					1887.330	1967.370
1246					1887.360	1967.400
1247					1887.390	1967.430
1248					1887.420	1967.460
1249					1887.450	1967.490
1250					1887.480	1967.520
1251					1887.510	1967.550
1252					1887.540	1967.580
1253					1887.570	1967.610
1254					1887.600	1967.640
1255					1887.630	1967.670
1256					1887.660	1967.700
1257					1887.690	1967.730
1258					1887.720	1967.760
1259					1887.750	1967.790
1260					1887.780	1967.820
1261					1887.810	1967.850
1262					1887.840	1967.880
1263					1887.870	1967.910
1264					1887.900	1967.940
1265					1887.930	1967.970
1266					1887.960	1968.000
1267					1887.990	1968.030
1268					1888.020	1968.060
1269					1888.050	1968.090
1270					1888.080	1968.120
1271					1888.110	1968.150
1272					1888.140	1968.180
1273					1888.170	1968.210
1274					1888.200	1968.240
1275					1888.230	1968.270
1276					1888.260	1968.300
1277					1888.290	1968.330
1278					1888.320	1968.360
1279					1888.350	1968.390
1280					1888.380	1968.420

Table B-1 NADC/NAMPS Cellular Channel Numbers and Frequencies (cont)

CHANNEL NUMBER	BAND					
	NADC-U4		NADC-U8		NADC-HY	
	MOBILE TRANSMIT (MHz)	MOBILE RECEIVE (MHz)	MOBILE TRANSMIT (MHz)	MOBILE RECEIVE (MHz)	MOBILE TRANSMIT (MHz)	MOBILE RECEIVE (MHz)
1281					1888.410	1968.450
1282					1888.440	1968.480
1283					1888.470	1968.510
1284					1888.500	1968.540
1285					1888.530	1968.570
1286					1888.560	1968.600
1287					1888.590	1968.630
1288					1888.620	1968.660
1289					1888.650	1968.690
1290					1888.680	1968.720
1291					1888.710	1968.750
1292					1888.740	1968.780
1293					1888.770	1968.810
1294					1888.800	1968.840
1295					1888.830	1968.870
1296					1888.860	1968.900
1297					1888.890	1968.930
1298					1888.920	1968.960
1299					1888.950	1968.990
1300					1888.980	1969.020
1301					1889.010	1969.050
1302					1889.040	1969.080
1303					1889.070	1969.110
1304					1889.100	1969.140
1305					1889.130	1969.170
1306					1889.160	1969.200
1307					1889.190	1969.230
1308					1889.220	1969.260
1309					1889.250	1969.290
1310					1889.280	1969.320
1311					1889.310	1969.350
1312					1889.340	1969.380
1313					1889.370	1969.410
1314					1889.400	1969.440
1315					1889.430	1969.470
1316					1889.460	1969.500
1317					1889.490	1969.530
1318					1889.520	1969.560
1319					1889.550	1969.590
1320					1889.580	1969.620

Table B-1 NADC/NAMPS Cellular Channel Numbers and Frequencies (cont)

CHANNEL NUMBER	BAND					
	NADC-U4		NADC-U8		NADC-HY	
	MOBILE TRANSMIT (MHz)	MOBILE RECEIVE (MHz)	MOBILE TRANSMIT (MHz)	MOBILE RECEIVE (MHz)	MOBILE TRANSMIT (MHz)	MOBILE RECEIVE (MHz)
1321					1889.610	1969.650
1322					1889.640	1969.680
1323					1889.670	1969.710
1324					1889.700	1969.740
1325					1889.730	1969.770
1326					1889.760	1969.800
1327					1889.790	1969.830
1328					1889.820	1969.860
1329					1889.850	1969.890
1330					1889.880	1969.920
1331					1889.910	1969.950
1332					1889.940	1969.980
1333					1889.970	1970.010
1334					1890.000	1970.040
1335					1890.030	1970.070
1336					1890.060	1970.100
1337					1890.090	1970.130
1338					1890.120	1970.160
1339					1890.150	1970.190
1340					1890.180	1970.220
1341					1890.210	1970.250
1342					1890.240	1970.280
1343					1890.270	1970.310
1344					1890.300	1970.340
1345					1890.330	1970.370
1346					1890.360	1970.400
1347					1890.390	1970.430
1348					1890.420	1970.460
1349					1890.450	1970.490
1350					1890.480	1970.520
1351					1890.510	1970.550
1352					1890.540	1970.580
1353					1890.570	1970.610
1354					1890.600	1970.640
1355					1890.630	1970.670
1356					1890.660	1970.700
1357					1890.690	1970.730
1358					1890.720	1970.760
1359					1890.750	1970.790
1360					1890.780	1970.820

Table B-1 NADC/NAMPS Cellular Channel Numbers and Frequencies (cont)

CHANNEL NUMBER	BAND					
	NADC-U4		NADC-U8		NADC-HY	
	MOBILE TRANSMIT (MHz)	MOBILE RECEIVE (MHz)	MOBILE TRANSMIT (MHz)	MOBILE RECEIVE (MHz)	MOBILE TRANSMIT (MHz)	MOBILE RECEIVE (MHz)
1361					1890.810	1970.850
1362					1890.840	1970.880
1363					1890.870	1970.910
1364					1890.900	1970.940
1365					1890.930	1970.970
1366					1890.960	1971.000
1367					1890.990	1971.030
1368					1891.020	1971.060
1369					1891.050	1971.090
1370					1891.080	1971.120
1371					1891.110	1971.150
1372					1891.140	1971.180
1373					1891.170	1971.210
1374					1891.200	1971.240
1375					1891.230	1971.270
1376					1891.260	1971.300
1377					1891.290	1971.330
1378					1891.320	1971.360
1379					1891.350	1971.390
1380					1891.380	1971.420
1381					1891.410	1971.450
1382					1891.440	1971.480
1383					1891.470	1971.510
1384					1891.500	1971.540
1385					1891.530	1971.570
1386					1891.560	1971.600
1387					1891.590	1971.630
1388					1891.620	1971.660
1389					1891.650	1971.690
1390					1891.680	1971.720
1391					1891.710	1971.750
1392					1891.740	1971.780
1393					1891.770	1971.810
1394					1891.800	1971.840
1395					1891.830	1971.870
1396					1891.860	1971.900
1397					1891.890	1971.930
1398					1891.920	1971.960
1399					1891.950	1971.990
1400					1891.980	1972.020

Table B-1 NADC/NAMPS Cellular Channel Numbers and Frequencies (cont)

CHANNEL NUMBER	BAND					
	NADC-U4		NADC-U8		NADC-HY	
	MOBILE TRANSMIT (MHz)	MOBILE RECEIVE (MHz)	MOBILE TRANSMIT (MHz)	MOBILE RECEIVE (MHz)	MOBILE TRANSMIT (MHz)	MOBILE RECEIVE (MHz)
1401					1892.010	1972.050
1402					1892.040	1972.080
1403					1892.070	1972.110
1404					1892.100	1972.140
1405					1892.130	1972.170
1406					1892.160	1972.200
1407					1892.190	1972.230
1408					1892.220	1972.260
1409					1892.250	1972.290
1410					1892.280	1972.320
1411					1892.310	1972.350
1412					1892.340	1972.380
1413					1892.370	1972.410
1414					1892.400	1972.440
1415					1892.430	1972.470
1416					1892.460	1972.500
1417					1892.490	1972.530
1418					1892.520	1972.560
1419					1892.550	1972.590
1420					1892.580	1972.620
1421					1892.610	1972.650
1422					1892.640	1972.680
1423					1892.670	1972.710
1424					1892.700	1972.740
1425					1892.730	1972.770
1426					1892.760	1972.800
1427					1892.790	1972.830
1428					1892.820	1972.860
1429					1892.850	1972.890
1430					1892.880	1972.920
1431					1892.910	1972.950
1432					1892.940	1972.980
1433					1892.970	1973.010
1434					1893.000	1973.040
1435					1893.030	1973.070
1436					1893.060	1973.100
1437					1893.090	1973.130
1438					1893.120	1973.160
1439					1893.150	1973.190
1440					1893.180	1973.220

Table B-1 NADC/NAMPS Cellular Channel Numbers and Frequencies (cont)

CHANNEL NUMBER	BAND					
	NADC-U4		NADC-U8		NADC-HY	
	MOBILE TRANSMIT (MHz)	MOBILE RECEIVE (MHz)	MOBILE TRANSMIT (MHz)	MOBILE RECEIVE (MHz)	MOBILE TRANSMIT (MHz)	MOBILE RECEIVE (MHz)
1441					1893.210	1973.250
1442					1893.240	1973.280
1443					1893.270	1973.310
1444					1893.300	1973.340
1445					1893.330	1973.370
1446					1893.360	1973.400
1447					1893.390	1973.430
1448					1893.420	1973.460
1449					1893.450	1973.490
1450					1893.480	1973.520
1451					1893.510	1973.550
1452					1893.540	1973.580
1453					1893.570	1973.610
1454					1893.600	1973.640
1455					1893.630	1973.670
1456					1893.660	1973.700
1457					1893.690	1973.730
1458					1893.720	1973.760
1459					1893.750	1973.790
1460					1893.780	1973.820
1461					1893.810	1973.850
1462					1893.840	1973.880
1463					1893.870	1973.910
1464					1893.900	1973.940
1465					1893.930	1973.970
1466					1893.960	1974.000
1467					1893.990	1974.030
1468					1894.020	1974.060
1469					1894.050	1974.090
1470					1894.080	1974.120
1471					1894.110	1974.150
1472					1894.140	1974.180
1473					1894.170	1974.210
1474					1894.200	1974.240
1475					1894.230	1974.270
1476					1894.260	1974.300
1477					1894.290	1974.330
1478					1894.320	1974.360
1479					1894.350	1974.390
1480					1894.380	1974.420

Table B-1 NADC/NAMPS Cellular Channel Numbers and Frequencies (cont)



CHANNEL NUMBER	BAND					
	NADC-U4		NADC-U8		NADC-HY	
	MOBILE TRANSMIT (MHz)	MOBILE RECEIVE (MHz)	MOBILE TRANSMIT (MHz)	MOBILE RECEIVE (MHz)	MOBILE TRANSMIT (MHz)	MOBILE RECEIVE (MHz)
1481					1894.410	1974.450
1482					1894.440	1974.480
1483					1894.470	1974.510
1484					1894.500	1974.540
1485					1894.530	1974.570
1486					1894.560	1974.600
1487					1894.590	1974.630
1488					1894.620	1974.660
1489					1894.650	1974.690
1490					1894.680	1974.720
1491					1894.710	1974.750
1492					1894.740	1974.780
1493					1894.770	1974.810
1494					1894.800	1974.840
1495					1894.830	1974.870
1496					1894.860	1974.900
1497					1894.890	1974.930
1498					1894.920	1974.960
1499					1894.950	1974.990
1500					1894.980	1975.020
1501					1895.010	1975.050
1502					1895.040	1975.080
1503					1895.070	1975.110
1504					1895.100	1975.140
1505					1895.130	1975.170
1506					1895.160	1975.200
1507					1895.190	1975.230
1508					1895.220	1975.260
1509					1895.250	1975.290
1510					1895.280	1975.320
1511					1895.310	1975.350
1512					1895.340	1975.380
1513					1895.370	1975.410
1514					1895.400	1975.440
1515					1895.430	1975.470
1516					1895.460	1975.500
1517					1895.490	1975.530
1518					1895.520	1975.560
1519					1895.550	1975.590
1520					1895.580	1975.620

Table B-1 NADC/NAMPS Cellular Channel Numbers and Frequencies (cont)

CHANNEL NUMBER	BAND					
	NADC-U4		NADC-U8		NADC-HY	
	MOBILE TRANSMIT (MHz)	MOBILE RECEIVE (MHz)	MOBILE TRANSMIT (MHz)	MOBILE RECEIVE (MHz)	MOBILE TRANSMIT (MHz)	MOBILE RECEIVE (MHz)
1521					1895.610	1975.650
1522					1895.640	1975.680
1523					1895.670	1975.710
1524					1895.700	1975.740
1525					1895.730	1975.770
1526					1895.760	1975.800
1527					1895.790	1975.830
1528					1895.820	1975.860
1529					1895.850	1975.890
1530					1895.880	1975.920
1531					1895.910	1975.950
1532					1895.940	1975.980
1533					1895.970	1976.010
1534					1896.000	1976.040
1535					1896.030	1976.070
1536					1896.060	1976.100
1537					1896.090	1976.130
1538					1896.120	1976.160
1539					1896.150	1976.190
1540					1896.180	1976.220
1541					1896.210	1976.250
1542					1896.240	1976.280
1543					1896.270	1976.310
1544					1896.300	1976.340
1545					1896.330	1976.370
1546					1896.360	1976.400
1547					1896.390	1976.430
1548					1896.420	1976.460
1549					1896.450	1976.490
1550					1896.480	1976.520
1551					1896.510	1976.550
1552					1896.540	1976.580
1553					1896.570	1976.610
1554					1896.600	1976.640
1555					1896.630	1976.670
1556					1896.660	1976.700
1557					1896.690	1976.730
1558					1896.720	1976.760
1559					1896.750	1976.790
1560					1896.780	1976.820

Table B-1 NADC/NAMPS Cellular Channel Numbers and Frequencies (cont)

CHANNEL NUMBER	BAND					
	NADC-U4		NADC-U8		NADC-HY	
	MOBILE TRANSMIT (MHz)	MOBILE RECEIVE (MHz)	MOBILE TRANSMIT (MHz)	MOBILE RECEIVE (MHz)	MOBILE TRANSMIT (MHz)	MOBILE RECEIVE (MHz)
1561					1896.810	1976.850
1562					1896.840	1976.880
1563					1896.870	1976.910
1564					1896.900	1976.940
1565					1896.930	1976.970
1566					1896.960	1977.000
1567					1896.990	1977.030
1568					1897.020	1977.060
1569					1897.050	1977.090
1570					1897.080	1977.120
1571					1897.110	1977.150
1572					1897.140	1977.180
1573					1897.170	1977.210
1574					1897.200	1977.240
1575					1897.230	1977.270
1576					1897.260	1977.300
1577					1897.290	1977.330
1578					1897.320	1977.360
1579					1897.350	1977.390
1580					1897.380	1977.420
1581					1897.410	1977.450
1582					1897.440	1977.480
1583					1897.470	1977.510
1584					1897.500	1977.540
1585					1897.530	1977.570
1586					1897.560	1977.600
1587					1897.590	1977.630
1588					1897.620	1977.660
1589					1897.650	1977.690
1590					1897.680	1977.720
1591					1897.710	1977.750
1592					1897.740	1977.780
1593					1897.770	1977.810
1594					1897.800	1977.840
1595					1897.830	1977.870
1596					1897.860	1977.900
1597					1897.890	1977.930
1598					1897.920	1977.960
1599					1897.950	1977.990
1600					1897.980	1978.020

Table B-1 NADC/NAMPS Cellular Channel Numbers and Frequencies (cont)

CHANNEL NUMBER	BAND					
	NADC-U4		NADC-U8		NADC-HY	
	MOBILE TRANSMIT (MHz)	MOBILE RECEIVE (MHz)	MOBILE TRANSMIT (MHz)	MOBILE RECEIVE (MHz)	MOBILE TRANSMIT (MHz)	MOBILE RECEIVE (MHz)
1601					1898.010	1978.050
1602					1898.040	1978.080
1603					1898.070	1978.110
1604					1898.100	1978.140
1605					1898.130	1978.170
1606					1898.160	1978.200
1607					1898.190	1978.230
1608					1898.220	1978.260
1609					1898.250	1978.290
1610					1898.280	1978.320
1611					1898.310	1978.350
1612					1898.340	1978.380
1613					1898.370	1978.410
1614					1898.400	1978.440
1615					1898.430	1978.470
1616					1898.460	1978.500
1617					1898.490	1978.530
1618					1898.520	1978.560
1619					1898.550	1978.590
1620					1898.580	1978.620
1621					1898.610	1978.650
1622					1898.640	1978.680
1623					1898.670	1978.710
1624					1898.700	1978.740
1625					1898.730	1978.770
1626					1898.760	1978.800
1627					1898.790	1978.830
1628					1898.820	1978.860
1629					1898.850	1978.890
1630					1898.880	1978.920
1631					1898.910	1978.950
1632					1898.940	1978.980
1633					1898.970	1979.010
1634					1899.000	1979.040
1635					1899.030	1979.070
1636					1899.060	1979.100
1637					1899.090	1979.130
1638					1899.120	1979.160
1639					1899.150	1979.190
1640					1899.180	1979.220

Table B-1 NADC/NAMPS Cellular Channel Numbers and Frequencies (cont)

CHANNEL NUMBER	BAND					
	NADC-U4		NADC-U8		NADC-HY	
	MOBILE TRANSMIT (MHz)	MOBILE RECEIVE (MHz)	MOBILE TRANSMIT (MHz)	MOBILE RECEIVE (MHz)	MOBILE TRANSMIT (MHz)	MOBILE RECEIVE (MHz)
1641					1899.210	1979.250
1642					1899.240	1979.280
1643					1899.270	1979.310
1644					1899.300	1979.340
1645					1899.330	1979.370
1646					1899.360	1979.400
1647					1899.390	1979.430
1648					1899.420	1979.460
1649					1899.450	1979.490
1650					1899.480	1979.520
1651					1899.510	1979.550
1652					1899.540	1979.580
1653					1899.570	1979.610
1654					1899.600	1979.640
1655					1899.630	1979.670
1656					1899.660	1979.700
1657					1899.690	1979.730
1658					1899.720	1979.760
1659					1899.750	1979.790
1660					1899.780	1979.820
1661					1899.810	1979.850
1662					1899.840	1979.880
1663					1899.870	1979.910
1664					1899.900	1979.940
1665					1899.930	1979.970
1666					1899.960	1980.000
1667					1899.990	1980.030
1668					1900.020	1980.060
1669					1900.050	1980.090
1670					1900.080	1980.120
1671					1900.110	1980.150
1672					1900.140	1980.180
1673					1900.170	1980.210
1674					1900.200	1980.240
1675					1900.230	1980.270
1676					1900.260	1980.300
1677					1900.290	1980.330
1678					1900.320	1980.360
1679					1900.350	1980.390
1680					1900.380	1980.420

Table B-1 NADC/NAMPS Cellular Channel Numbers and Frequencies (cont)

CHANNEL NUMBER	BAND					
	NADC-U4		NADC-U8		NADC-HY	
	MOBILE TRANSMIT (MHz)	MOBILE RECEIVE (MHz)	MOBILE TRANSMIT (MHz)	MOBILE RECEIVE (MHz)	MOBILE TRANSMIT (MHz)	MOBILE RECEIVE (MHz)
1681					1900.410	1980.450
1682					1900.440	1980.480
1683					1900.470	1980.510
1684					1900.500	1980.540
1685					1900.530	1980.570
1686					1900.560	1980.600
1687					1900.590	1980.630
1688					1900.620	1980.660
1689					1900.650	1980.690
1690					1900.680	1980.720
1691					1900.710	1980.750
1692					1900.740	1980.780
1693					1900.770	1980.810
1694					1900.800	1980.840
1695					1900.830	1980.870
1696					1900.860	1980.900
1697					1900.890	1980.930
1698					1900.920	1980.960
1699					1900.950	1980.990
1700					1900.980	1981.020
1701					1901.010	1981.050
1702					1901.040	1981.080
1703					1901.070	1981.110
1704					1901.100	1981.140
1705					1901.130	1981.170
1706					1901.160	1981.200
1707					1901.190	1981.230
1708					1901.220	1981.260
1709					1901.250	1981.290
1710					1901.280	1981.320
1711					1901.310	1981.350
1712					1901.340	1981.380
1713					1901.370	1981.410
1714					1901.400	1981.440
1715					1901.430	1981.470
1716					1901.460	1981.500
1717					1901.490	1981.530
1718					1901.520	1981.560
1719					1901.550	1981.590
1720					1901.580	1981.620

Table B-1 NADC/NAMPS Cellular Channel Numbers and Frequencies (cont)

CHANNEL NUMBER	BAND					
	NADC-U4		NADC-U8		NADC-HY	
	MOBILE TRANSMIT (MHz)	MOBILE RECEIVE (MHz)	MOBILE TRANSMIT (MHz)	MOBILE RECEIVE (MHz)	MOBILE TRANSMIT (MHz)	MOBILE RECEIVE (MHz)
1721					1901.610	1981.650
1722					1901.640	1981.680
1723					1901.670	1981.710
1724					1901.700	1981.740
1725					1901.730	1981.770
1726					1901.760	1981.800
1727					1901.790	1981.830
1728					1901.820	1981.860
1729					1901.850	1981.890
1730					1901.880	1981.920
1731					1901.910	1981.950
1732					1901.940	1981.980
1733					1901.970	1982.010
1734					1902.000	1982.040
1735					1902.030	1982.070
1736					1902.060	1982.100
1737					1902.090	1982.130
1738					1902.120	1982.160
1739					1902.150	1982.190
1740					1902.180	1982.220
1741					1902.210	1982.250
1742					1902.240	1982.280
1743					1902.270	1982.310
1744					1902.300	1982.340
1745					1902.330	1982.370
1746					1902.360	1982.400
1747					1902.390	1982.430
1748					1902.420	1982.460
1749					1902.450	1982.490
1750					1902.480	1982.520
1751					1902.510	1982.550
1752					1902.540	1982.580
1753					1902.570	1982.610
1754					1902.600	1982.640
1755					1902.630	1982.670
1756					1902.660	1982.700
1757					1902.690	1982.730
1758					1902.720	1982.760
1759					1902.750	1982.790
1760					1902.780	1982.820

Table B-1 NADC/NAMPS Cellular Channel Numbers and Frequencies (cont)

CHANNEL NUMBER	BAND					
	NADC-U4		NADC-U8		NADC-HY	
	MOBILE TRANSMIT (MHz)	MOBILE RECEIVE (MHz)	MOBILE TRANSMIT (MHz)	MOBILE RECEIVE (MHz)	MOBILE TRANSMIT (MHz)	MOBILE RECEIVE (MHz)
1761					1902.810	1982.850
1762					1902.840	1982.880
1763					1902.870	1982.910
1764					1902.900	1982.940
1765					1902.930	1982.970
1766					1902.960	1983.000
1767					1902.990	1983.030
1768					1903.020	1983.060
1769					1903.050	1983.090
1770					1903.080	1983.120
1771					1903.110	1983.150
1772					1903.140	1983.180
1773					1903.170	1983.210
1774					1903.200	1983.240
1775					1903.230	1983.270
1776					1903.260	1983.300
1777					1903.290	1983.330
1778					1903.320	1983.360
1779					1903.350	1983.390
1780					1903.380	1983.420
1781					1903.410	1983.450
1782					1903.440	1983.480
1783					1903.470	1983.510
1784					1903.500	1983.540
1785					1903.530	1983.570
1786					1903.560	1983.600
1787					1903.590	1983.630
1788					1903.620	1983.660
1789					1903.650	1983.690
1790					1903.680	1983.720
1791					1903.710	1983.750
1792					1903.740	1983.780
1793					1903.770	1983.810
1794					1903.800	1983.840
1795					1903.830	1983.870
1796					1903.860	1983.900
1797					1903.890	1983.930
1798					1903.920	1983.960
1799					1903.950	1983.990
1800					1903.980	1984.020

Table B-1 NADC/NAMPS Cellular Channel Numbers and Frequencies (cont)



CHANNEL NUMBER	BAND					
	NADC-U4		NADC-U8		NADC-HY	
	MOBILE TRANSMIT (MHz)	MOBILE RECEIVE (MHz)	MOBILE TRANSMIT (MHz)	MOBILE RECEIVE (MHz)	MOBILE TRANSMIT (MHz)	MOBILE RECEIVE (MHz)
1801					1904.010	1984.050
1802					1904.040	1984.080
1803					1904.070	1984.110
1804					1904.100	1984.140
1805					1904.130	1984.170
1806					1904.160	1984.200
1807					1904.190	1984.230
1808					1904.220	1984.260
1809					1904.250	1984.290
1810					1904.280	1984.320
1811					1904.310	1984.350
1812					1904.340	1984.380
1813					1904.370	1984.410
1814					1904.400	1984.440
1815					1904.430	1984.470
1816					1904.460	1984.500
1817					1904.490	1984.530
1818					1904.520	1984.560
1819					1904.550	1984.590
1820					1904.580	1984.620
1821					1904.610	1984.650
1822					1904.640	1984.680
1823					1904.670	1984.710
1824					1904.700	1984.740
1825					1904.730	1984.770
1826					1904.760	1984.800
1827					1904.790	1984.830
1828					1904.820	1984.860
1829					1904.850	1984.890
1830					1904.880	1984.920
1831					1904.910	1984.950
1832					1904.940	1984.980
1833					1904.970	1985.010
1834					1905.000	1985.040
1835					1905.030	1985.070
1836					1905.060	1985.100
1837					1905.090	1985.130
1838					1905.120	1985.160
1839					1905.150	1985.190
1840					1905.180	1985.220

Table B-1 NADC/NAMPS Cellular Channel Numbers and Frequencies (cont)

CHANNEL NUMBER	BAND					
	NADC-U4		NADC-U8		NADC-HY	
	MOBILE TRANSMIT (MHz)	MOBILE RECEIVE (MHz)	MOBILE TRANSMIT (MHz)	MOBILE RECEIVE (MHz)	MOBILE TRANSMIT (MHz)	MOBILE RECEIVE (MHz)
1841					1905.210	1985.250
1842					1905.240	1985.280
1843					1905.270	1985.310
1844					1905.300	1985.340
1845					1905.330	1985.370
1846					1905.360	1985.400
1847					1905.390	1985.430
1848					1905.420	1985.460
1849					1905.450	1985.490
1850					1905.480	1985.520
1851					1905.510	1985.550
1852					1905.540	1985.580
1853					1905.570	1985.610
1854					1905.600	1985.640
1855					1905.630	1985.670
1856					1905.660	1985.700
1857					1905.690	1985.730
1858					1905.720	1985.760
1859					1905.750	1985.790
1860					1905.780	1985.820
1861					1905.810	1985.850
1862					1905.840	1985.880
1863					1905.870	1985.910
1864					1905.900	1985.940
1865					1905.930	1985.970
1866					1905.960	1986.000
1867					1905.990	1986.030
1868					1906.020	1986.060
1869					1906.050	1986.090
1870					1906.080	1986.120
1871					1906.110	1986.150
1872					1906.140	1986.180
1873					1906.170	1986.210
1874					1906.200	1986.240
1875					1906.230	1986.270
1876					1906.260	1986.300
1877					1906.290	1986.330
1878					1906.320	1986.360
1879					1906.350	1986.390
1880					1906.380	1986.420

Table B-1 NADC/NAMPS Cellular Channel Numbers and Frequencies (cont)

CHANNEL NUMBER	BAND					
	NADC-U4		NADC-U8		NADC-HY	
	MOBILE TRANSMIT (MHz)	MOBILE RECEIVE (MHz)	MOBILE TRANSMIT (MHz)	MOBILE RECEIVE (MHz)	MOBILE TRANSMIT (MHz)	MOBILE RECEIVE (MHz)
1881					1906.410	1986.450
1882					1906.440	1986.480
1883					1906.470	1986.510
1884					1906.500	1986.540
1885					1906.530	1986.570
1886					1906.560	1986.600
1887					1906.590	1986.630
1888					1906.620	1986.660
1889					1906.650	1986.690
1890					1906.680	1986.720
1891					1906.710	1986.750
1892					1906.740	1986.780
1893					1906.770	1986.810
1894					1906.800	1986.840
1895					1906.830	1986.870
1896					1906.860	1986.900
1897					1906.890	1986.930
1898					1906.920	1986.960
1899					1906.950	1986.990
1900					1906.980	1987.020
1901					1907.010	1987.050
1902					1907.040	1987.080
1903					1907.070	1987.110
1904					1907.100	1987.140
1905					1907.130	1987.170
1906					1907.160	1987.200
1907					1907.190	1987.230
1908					1907.220	1987.260
1909					1907.250	1987.290
1910					1907.280	1987.320
1911					1907.310	1987.350
1912					1907.340	1987.380
1913					1907.370	1987.410
1914					1907.400	1987.440
1915					1907.430	1987.470
1916					1907.460	1987.500
1917					1907.490	1987.530
1918					1907.520	1987.560
1919					1907.550	1987.590
1920					1907.580	1987.620

Table B-1 NADC/NAMPS Cellular Channel Numbers and Frequencies (cont)

CHANNEL NUMBER	BAND					
	NADC-U4		NADC-U8		NADC-HY	
	MOBILE TRANSMIT (MHz)	MOBILE RECEIVE (MHz)	MOBILE TRANSMIT (MHz)	MOBILE RECEIVE (MHz)	MOBILE TRANSMIT (MHz)	MOBILE RECEIVE (MHz)
1921					1907.610	1987.650
1922					1907.640	1987.680
1923					1907.670	1987.710
1924					1907.700	1987.740
1925					1907.730	1987.770
1926					1907.760	1987.800
1927					1907.790	1987.830
1928					1907.820	1987.860
1929					1907.850	1987.890
1930					1907.880	1987.920
1931					1907.910	1987.950
1932					1907.940	1987.980
1933					1907.970	1988.010
1934					1908.000	1988.040
1935					1908.030	1988.070
1936					1908.060	1988.100
1937					1908.090	1988.130
1938					1908.120	1988.160
1939					1908.150	1988.190
1940					1908.180	1988.220
1941					1908.210	1988.250
1942					1908.240	1988.280
1943					1908.270	1988.310
1944					1908.300	1988.340
1945					1908.330	1988.370
1946					1908.360	1988.400
1947					1908.390	1988.430
1948					1908.420	1988.460
1949					1908.450	1988.490
1950					1908.480	1988.520
1951					1908.510	1988.550
1952					1908.540	1988.580
1953					1908.570	1988.610
1954					1908.600	1988.640
1955					1908.630	1988.670
1956					1908.660	1988.700
1957					1908.690	1988.730
1958					1908.720	1988.760
1959					1908.750	1988.790
1960					1908.780	1988.820

Table B-1 NADC/NAMPS Cellular Channel Numbers and Frequencies (cont)

CHANNEL NUMBER	BAND					
	NADC-U4		NADC-U8		NADC-HY	
	MOBILE TRANSMIT (MHz)	MOBILE RECEIVE (MHz)	MOBILE TRANSMIT (MHz)	MOBILE RECEIVE (MHz)	MOBILE TRANSMIT (MHz)	MOBILE RECEIVE (MHz)
1961					1908.810	1988.850
1962					1908.840	1988.880
1963					1908.870	1988.910
1964					1908.900	1988.940
1965					1908.930	1988.970
1966					1908.960	1989.000
1967					1908.990	1989.030
1968					1909.020	1989.060
1969					1909.050	1989.090
1970					1909.080	1989.120
1971					1909.110	1989.150
1972					1909.140	1989.180
1973					1909.170	1989.210
1974					1909.200	1989.240
1975					1909.230	1989.270
1976					1909.260	1989.300
1977					1909.290	1989.330
1978					1909.320	1989.360
1979					1909.350	1989.390
1980					1909.380	1989.420
1981					1909.410	1989.450
1982					1909.440	1989.480
1983					1909.470	1989.510
1984					1909.500	1989.540
1985					1909.530	1989.570
1986					1909.560	1989.600
1987					1909.590	1989.630
1988					1909.620	1989.660
1989					1909.650	1989.690
1990					1909.680	1989.720
1991					1909.710	1989.750
1992					1909.740	1989.780
1993					1909.770	1989.810
1994					1909.800	1989.840
1995					1909.830	1989.870
1996					1909.860	1989.900
1997					1909.890	1989.930
1998					1909.920	1989.960
1999					1909.950	1989.990

Table B-1 NADC/NAMPS Cellular Channel Numbers and Frequencies (cont)

- Notes:
1. Channel numbers 800 through 866 of the NADC-U8 (AMPS) band are not presently assigned to any cellular telephone system.
  2. Frequencies for channel numbers 867 through 989 of the NADC-U8 (AMPS) band are not assigned and are not used by cellular telephone systems.
  3. Channel number 990 of the NADC-U8 (AMPS) band is not assigned to any system.

# APPENDIX C - TACS/E-TACS CELLULAR TELEPHONE CHANNEL NUMBERS AND CENTER FREQUENCIES

CHANNEL NUMBER	MOBILE TRANSMIT (MHz)	MOBILE RECEIVE (MHz)	CHANNEL NUMBER	MOBILE TRANSMIT (MHz)	MOBILE RECEIVE (MHz)
1	890.0125	935.0125	51	891.2625	936.2625
2	890.0375	935.0375	52	891.2875	936.2875
3	890.0625	935.0625	53	891.3125	936.3125
4	890.0875	935.0875	54	891.3375	936.3375
5	890.1125	935.1125	55	891.3625	936.3625
6	890.1375	935.1375	56	891.3875	936.3875
7	890.1625	935.1625	57	891.4125	936.4125
8	890.1875	935.1875	58	891.4375	936.4375
9	890.2125	935.2125	59	891.4625	936.4625
10	890.2375	935.2375	60	891.4875	936.4875
11	890.2625	935.2625	61	891.5125	936.5125
12	890.2875	935.2875	62	891.5375	936.5375
13	890.3125	935.3125	63	891.5625	936.5625
14	890.3375	935.3375	64	891.5875	936.5875
15	890.3625	935.3625	65	891.6125	936.6125
16	890.3875	935.3875	66	891.6375	936.6375
17	890.4125	935.4125	67	891.6625	936.6625
18	890.4375	935.4375	68	891.6875	936.6875
19	890.4625	935.4625	69	891.7125	936.7125
20	890.4875	935.4875	70	891.7375	936.7375
21	890.5125	935.5125	71	891.7625	936.7625
22	890.5375	935.5375	72	891.7875	936.7875
23	890.5625	935.5625	73	891.8125	936.8125
24	890.5875	935.5875	74	891.8375	936.8375
25	890.6125	935.6125	75	891.8625	936.8625
26	890.6375	935.6375	76	891.8875	936.8875
27	890.6625	935.6625	77	891.9125	936.9125
28	890.6875	935.6875	78	891.9375	936.9375
29	890.7125	935.7125	79	891.9625	936.9625
30	890.7375	935.7375	80	891.9875	936.9875
31	890.7625	935.7625	81	892.0125	937.0125
32	890.7875	935.7875	82	892.0375	937.0375
33	890.8125	935.8125	83	892.0625	937.0625
34	890.8375	935.8375	84	892.0875	937.0875
35	890.8625	935.8625	85	892.1125	937.1125
36	890.8875	935.8875	86	892.1375	937.1375
37	890.9125	935.9125	87	892.1625	937.1625
38	890.9375	935.9375	88	892.1875	937.1875
39	890.9625	935.9625	89	892.2125	937.2125
40	890.9875	935.9875	90	892.2375	937.2375
41	891.0125	936.0125	91	892.2625	937.2625
42	891.0375	936.0375	92	892.2875	937.2875
43	891.0625	936.0625	93	892.3125	937.3125
44	891.0875	936.0875	94	892.3375	937.3375
45	891.1125	936.1125	95	892.3625	937.3625
46	891.1375	936.1375	96	892.3875	937.3875
47	891.1625	936.1625	97	892.4125	937.4125
48	891.1875	936.1875	98	892.4375	937.4375
49	891.2125	936.2125	99	892.4625	937.4625
50	891.2375	936.2375	100	892.4875	937.4875

Table C-1 TACS/E-TACS Cellular Channel Numbers and Frequencies

<b>CHANNEL NUMBER</b>	<b>MOBILE TRANSMIT (MHz)</b>	<b>MOBILE RECEIVE (MHz)</b>	<b>CHANNEL NUMBER</b>	<b>MOBILE TRANSMIT (MHz)</b>	<b>MOBILE RECEIVE (MHz)</b>
101	892.5125	937.5125	151	893.7625	938.7625
102	892.5375	937.5375	152	893.7875	938.7875
103	892.5625	937.5625	153	893.8125	938.8125
104	892.5875	937.5875	154	893.8375	938.8375
105	892.6125	937.6125	155	893.8625	938.8625
106	892.6375	937.6375	156	893.8875	938.8875
107	892.6625	937.6625	157	893.9125	938.9125
108	892.6875	937.6875	158	893.9375	938.9375
109	892.7125	937.7125	159	893.9625	938.9625
110	892.7375	937.7375	160	893.9875	938.9875
111	892.7625	937.7625	161	894.0125	939.0125
112	892.7875	937.7875	162	894.0375	939.0375
113	892.8125	937.8125	163	894.0625	939.0625
114	892.8375	937.8375	164	894.0875	939.0875
115	892.8625	937.8625	165	894.1125	939.1125
116	892.8875	937.8875	166	894.1375	939.1375
117	892.9125	937.9125	167	894.1625	939.1625
118	892.9375	937.9375	168	894.1875	939.1875
119	892.9625	937.9625	169	894.2125	939.2125
120	892.9875	937.9875	170	894.2375	939.2375
121	893.0125	938.0125	171	894.2625	939.2625
122	893.0375	938.0375	172	894.2875	939.2875
123	893.0625	938.0625	173	894.3125	939.3125
124	893.0875	938.0875	174	894.3375	939.3375
125	893.1125	938.1125	175	894.3625	939.3625
126	893.1375	938.1375	176	894.3875	939.3875
127	893.1625	938.1625	177	894.4125	939.4125
128	893.1875	938.1875	178	894.4375	939.4375
129	893.2125	938.2125	179	894.4625	939.4625
130	893.2375	938.2375	180	894.4875	939.4875
131	893.2625	938.2625	181	894.5125	939.5125
132	893.2875	938.2875	182	894.5375	939.5375
133	893.3125	938.3125	183	894.5625	939.5625
134	893.3375	938.3375	184	894.5875	939.5875
135	893.3625	938.3625	185	894.6125	939.6125
136	893.3875	938.3875	186	894.6375	939.6375
137	893.4125	938.4125	187	894.6625	939.6625
138	893.4375	938.4375	188	894.6875	939.6875
139	893.4625	938.4625	189	894.7125	939.7125
140	893.4875	938.4875	190	894.7375	939.7375
141	893.5125	938.5125	191	894.7625	939.7625
142	893.5375	938.5375	192	894.7875	939.7875
143	893.5625	938.5625	193	894.8125	939.8125
144	893.5875	938.5875	194	894.8375	939.8375
145	893.6125	938.6125	195	894.8625	939.8625
146	893.6375	938.6375	196	894.8875	939.8875
147	893.6625	938.6625	197	894.9125	939.9125
148	893.6875	938.6875	198	894.9375	939.9375
149	893.7125	938.7125	199	894.9625	939.9625
150	893.7375	938.7375	200	894.9875	939.9875

Table C-1 TACS/E-TACS Cellular Channel Numbers and Frequencies (cont)

<b>CHANNEL NUMBER</b>	<b>MOBILE TRANSMIT (MHz)</b>	<b>MOBILE RECEIVE (MHz)</b>	<b>CHANNEL NUMBER</b>	<b>MOBILE TRANSMIT (MHz)</b>	<b>MOBILE RECEIVE (MHz)</b>
201	895.0125	940.0125	251	896.2625	941.2625
202	895.0375	940.0375	252	896.2875	941.2875
203	895.0625	940.0625	253	896.3125	941.3125
204	895.0875	940.0875	254	896.3375	941.3375
205	895.1125	940.1125	255	896.3625	941.3625
206	895.1375	940.1375	256	896.3875	941.3875
207	895.1625	940.1625	257	896.4125	941.4125
208	895.1875	940.1875	258	896.4375	941.4375
209	895.2125	940.2125	259	896.4625	941.4625
210	895.2375	940.2375	260	896.4875	941.4875
211	895.2625	940.2625	261	896.5125	941.5125
212	895.2875	940.2875	262	896.5375	941.5375
213	895.3125	940.3125	263	896.5625	941.5625
214	895.3375	940.3375	264	896.5875	941.5875
215	895.3625	940.3625	265	896.6125	941.6125
216	895.3875	940.3875	266	896.6375	941.6375
217	895.4125	940.4125	267	896.6625	941.6625
218	895.4375	940.4375	268	896.6875	941.6875
219	895.4625	940.4625	269	896.7125	941.7125
220	895.4875	940.4875	270	896.7375	941.7375
221	895.5125	940.5125	271	896.7625	941.7625
222	895.5375	940.5375	272	896.7875	941.7875
223	895.5625	940.5625	273	896.8125	941.8125
224	895.5875	940.5875	274	896.8375	941.8375
225	895.6125	940.6125	275	896.8625	941.8625
226	895.6375	940.6375	276	896.8875	941.8875
227	895.6625	940.6625	277	896.9125	941.9125
228	895.6875	940.6875	278	896.9375	941.9375
229	895.7125	940.7125	279	896.9625	941.9625
230	895.7375	940.7375	280	896.9875	941.9875
231	895.7625	940.7625	281	897.0125	942.0125
232	895.7875	940.7875	282	897.0375	942.0375
233	895.8125	940.8125	283	897.0625	942.0625
234	895.8375	940.8375	284	897.0875	942.0875
235	895.8625	940.8625	285	897.1125	942.1125
236	895.8875	940.8875	286	897.1375	942.1375
237	895.9125	940.9125	287	897.1625	942.1625
238	895.9375	940.9375	288	897.1875	942.1875
239	895.9625	940.9625	289	897.2125	942.2125
240	895.9875	940.9875	290	897.2375	942.2375
241	896.0125	941.0125	291	897.2625	942.2625
242	896.0375	941.0375	292	897.2875	942.2875
243	896.0625	941.0625	293	897.3125	942.3125
244	896.0875	941.0875	294	897.3375	942.3375
245	896.1125	941.1125	295	897.3625	942.3625
246	896.1375	941.1375	296	897.3875	942.3875
247	896.1625	941.1625	297	897.4125	942.4125
248	896.1875	941.1875	298	897.4375	942.4375
249	896.2125	941.2125	299	897.4625	942.4625
250	896.2375	941.2375	300	897.4875	942.4875

Table C-1 TACS/E-TACS Cellular Channel Numbers and Frequencies (cont)



CHANNEL NUMBER	MOBILE TRANSMIT (MHz)	MOBILE RECEIVE (MHz)	CHANNEL NUMBER	MOBILE TRANSMIT (MHz)	MOBILE RECEIVE (MHz)
301	897.5125	942.5125	351	898.7625	943.7625
302	897.5375	942.5375	352	898.7875	943.7875
303	897.5625	942.5625	353	898.8125	943.8125
304	897.5875	942.5875	354	898.8375	943.8375
305	897.6125	942.6125	355	898.8625	943.8625
306	897.6375	942.6375	356	898.8875	943.8875
307	897.6625	942.6625	357	898.9125	943.9125
308	897.6875	942.6875	358	898.9375	943.9375
309	897.7125	942.7125	359	898.9625	943.9625
310	897.7375	942.7375	360	898.9875	943.9875
311	897.7625	942.7625	361	899.0125	944.0125
312	897.7875	942.7875	362	899.0375	944.0375
313	897.8125	942.8125	363	899.0625	944.0625
314	897.8375	942.8375	364	899.0875	944.0875
315	897.8625	942.8625	365	899.1125	944.1125
316	897.8875	942.8875	366	899.1375	944.1375
317	897.9125	942.9125	367	899.1625	944.1625
318	897.9375	942.9375	368	899.1875	944.1875
319	897.9625	942.9625	369	899.2125	944.2125
320	897.9875	942.9875	370	899.2375	944.2375
321	898.0125	943.0125	371	899.2625	944.2625
322	898.0375	943.0375	372	899.2875	944.2875
323	898.0625	943.0625	373	899.3125	944.3125
324	898.0875	943.0875	374	899.3375	944.3375
325	898.1125	943.1125	375	899.3625	944.3625
326	898.1375	943.1375	376	899.3875	944.3875
327	898.1625	943.1625	377	899.4125	944.4125
328	898.1875	943.1875	378	899.4375	944.4375
329	898.2125	943.2125	379	899.4625	944.4625
330	898.2375	943.2375	380	899.4875	944.4875
331	898.2625	943.2625	381	899.5125	944.5125
332	898.2875	943.2875	382	899.5375	944.5375
333	898.3125	943.3125	383	899.5625	944.5625
334	898.3375	943.3375	384	899.5875	944.5875
335	898.3625	943.3625	385	899.6125	944.6125
336	898.3875	943.3875	386	899.6375	944.6375
337	898.4125	943.4125	387	899.6625	944.6625
338	898.4375	943.4375	388	899.6875	944.6875
339	898.4625	943.4625	389	899.7125	944.7125
340	898.4875	943.4875	390	899.7375	944.7375
341	898.5125	943.5125	391	899.7625	944.7625
342	898.5375	943.5375	392	899.7875	944.7875
343	898.5625	943.5625	393	899.8125	944.8125
344	898.5875	943.5875	394	899.8375	944.8375
345	898.6125	943.6125	395	899.8625	944.8625
346	898.6375	943.6375	396	899.8875	944.8875
347	898.6625	943.6625	397	899.9125	944.9125
348	898.6875	943.6875	398	899.9375	944.9375
349	898.7125	943.7125	399	899.9625	944.9625
350	898.7375	943.7375	400	899.9875	944.9875

Table C-1 TACS/E-TACS Cellular Channel Numbers and Frequencies (cont)

<b>CHANNEL NUMBER</b>	<b>MOBILE TRANSMIT (MHz)</b>	<b>MOBILE RECEIVE (MHz)</b>	<b>CHANNEL NUMBER</b>	<b>MOBILE TRANSMIT (MHz)</b>	<b>MOBILE RECEIVE (MHz)</b>
401	900.0125	945.0125	451	901.2625	946.2625
402	900.0375	945.0375	452	901.2875	946.2875
403	900.0625	945.0625	453	901.3125	946.3125
404	900.0875	945.0875	454	901.3375	946.3375
405	900.1125	945.1125	455	901.3625	946.3625
406	900.1375	945.1375	456	901.3875	946.3875
407	900.1625	945.1625	457	901.4125	946.4125
408	900.1875	945.1875	458	901.4375	946.4375
409	900.2125	945.2125	459	901.4625	946.4625
410	900.2375	945.2375	460	901.4875	946.4875
411	900.2625	945.2625	461	901.5125	946.5125
412	900.2875	945.2875	462	901.5375	946.5375
413	900.3125	945.3125	463	901.5625	946.5625
414	900.3375	945.3375	464	901.5875	946.5875
415	900.3625	945.3625	465	901.6125	946.6125
416	900.3875	945.3875	466	901.6375	946.6375
417	900.4125	945.4125	467	901.6625	946.6625
418	900.4375	945.4375	468	901.6875	946.6875
419	900.4625	945.4625	469	901.7125	946.7125
420	900.4875	945.4875	470	901.7375	946.7375
421	900.5125	945.5125	471	901.7625	946.7625
422	900.5375	945.5375	472	901.7875	946.7875
423	900.5625	945.5625	473	901.8125	946.8125
424	900.5875	945.5875	474	901.8375	946.8375
425	900.6125	945.6125	475	901.8625	946.8625
426	900.6375	945.6375	476	901.8875	946.8875
427	900.6625	945.6625	477	901.9125	946.9125
428	900.6875	945.6875	478	901.9375	946.9375
429	900.7125	945.7125	479	901.9625	946.9625
430	900.7375	945.7375	480	901.9875	946.9875
431	900.7625	945.7625	481	902.0125	947.0125
432	900.7875	945.7875	482	902.0375	947.0375
433	900.8125	945.8125	483	902.0625	947.0625
434	900.8375	945.8375	484	902.0875	947.0875
435	900.8625	945.8625	485	902.1125	947.1125
436	900.8875	945.8875	486	902.1375	947.1375
437	900.9125	945.9125	487	902.1625	947.1625
438	900.9375	945.9375	488	902.1875	947.1875
439	900.9625	945.9625	489	902.2125	947.2125
440	900.9875	945.9875	490	902.2375	947.2375
441	901.0125	946.0125	491	902.2625	947.2625
442	901.0375	946.0375	492	902.2875	947.2875
443	901.0625	946.0625	493	902.3125	947.3125
444	901.0875	946.0875	494	902.3375	947.3375
445	901.1125	946.1125	495	902.3625	947.3625
446	901.1375	946.1375	496	902.3875	947.3875
447	901.1625	946.1625	497	902.4125	947.4125
448	901.1875	946.1875	498	902.4375	947.4375
449	901.2125	946.2125	499	902.4625	947.4625
450	901.2375	946.2375	500	902.4875	947.4875

Table C-1 TACS/E-TACS Cellular Channel Numbers and Frequencies (cont)

CHANNEL NUMBER	MOBILE TRANSMIT (MHz)	MOBILE RECEIVE (MHz)	CHANNEL NUMBER	MOBILE TRANSMIT (MHz)	MOBILE RECEIVE (MHz)
501	902.5125	947.5125	551	903.7625	948.7625
502	902.5375	947.5375	552	903.7875	948.7875
503	902.5625	947.5625	553	903.8125	948.8125
504	902.5875	947.5875	554	903.8375	948.8375
505	902.6125	947.6125	555	903.8625	948.8625
506	902.6375	947.6375	556	903.8875	948.8875
507	902.6625	947.6625	557	903.9125	948.9125
508	902.6875	947.6875	558	903.9375	948.9375
509	902.7125	947.7125	559	903.9625	948.9625
510	902.7375	947.7375	560	903.9875	948.9875
511	902.7625	947.7625	561	904.0125	949.0125
512	902.7875	947.7875	562	904.0375	949.0375
513	902.8125	947.8125	563	904.0625	949.0625
514	902.8375	947.8375	564	904.0875	949.0875
515	902.8625	947.8625	565	904.1125	949.1125
516	902.8875	947.8875	566	904.1375	949.1375
517	902.9125	947.9125	567	904.1625	949.1625
518	902.9375	947.9375	568	904.1875	949.1875
519	902.9625	947.9625	569	904.2125	949.2125
520	902.9875	947.9875	570	904.2375	949.2375
521	903.0125	948.0125	571	904.2625	949.2625
522	903.0375	948.0375	572	904.2875	949.2875
523	903.0625	948.0625	573	904.3125	949.3125
524	903.0875	948.0875	574	904.3375	949.3375
525	903.1125	948.1125	575	904.3625	949.3625
526	903.1375	948.1375	576	904.3875	949.3875
527	903.1625	948.1625	577	904.4125	949.4125
528	903.1875	948.1875	578	904.4375	949.4375
529	903.2125	948.2125	579	904.4625	949.4625
530	903.2375	948.2375	580	904.4875	949.4875
531	903.2625	948.2625	581	904.5125	949.5125
532	903.2875	948.2875	582	904.5375	949.5375
533	903.3125	948.3125	583	904.5625	949.5625
534	903.3375	948.3375	584	904.5875	949.5875
535	903.3625	948.3625	585	904.6125	949.6125
536	903.3875	948.3875	586	904.6375	949.6375
537	903.4125	948.4125	587	904.6625	949.6625
538	903.4375	948.4375	588	904.6875	949.6875
539	903.4625	948.4625	589	904.7125	949.7125
540	903.4875	948.4875	590	904.7375	949.7375
541	903.5125	948.5125	591	904.7625	949.7625
542	903.5375	948.5375	592	904.7875	949.7875
543	903.5625	948.5625	593	904.8125	949.8125
544	903.5875	948.5875	594	904.8375	949.8375
545	903.6125	948.6125	595	904.8625	949.8625
546	903.6375	948.6375	596	904.8875	949.8875
547	903.6625	948.6625	597	904.9125	949.9125
548	903.6875	948.6875	598	904.9375	949.9375
549	903.7125	948.7125	599	904.9625	949.9625
550	903.7375	948.7375	600	904.9875	949.9875

Table C-1 TACS/E-TACS Cellular Channel Numbers and Frequencies (cont)

<b>CHANNEL NUMBER</b>	<b>MOBILE TRANSMIT (MHz)</b>	<b>MOBILE RECEIVE (MHz)</b>	<b>CHANNEL NUMBER</b>	<b>MOBILE TRANSMIT (MHz)</b>	<b>MOBILE RECEIVE (MHz)</b>
601	905.0125	950.0125	651	906.2625	951.2625
602	905.0375	950.0375	652	906.2875	951.2875
603	905.0625	950.0625	653	906.3125	951.3125
604	905.0875	950.0875	654	906.3375	951.3375
605	905.1125	950.1125	655	906.3625	951.3625
606	905.1375	950.1375	656	906.3875	951.3875
607	905.1625	950.1625	657	906.4125	951.4125
608	905.1875	950.1875	658	906.4375	951.4375
609	905.2125	950.2125	659	906.4625	951.4625
610	905.2375	950.2375	660	906.4875	951.4875
611	905.2625	950.2625	661	906.5125	951.5125
612	905.2875	950.2875	662	906.5375	951.5375
613	905.3125	950.3125	663	906.5625	951.5625
614	905.3375	950.3375	664	906.5875	951.5875
615	905.3625	950.3625	665	906.6125	951.6125
616	905.3875	950.3875	666	906.6375	951.6375
617	905.4125	950.4125	667	906.6625	951.6625
618	905.4375	950.4375	668	906.6875	951.6875
619	905.4625	950.4625	669	906.7125	951.7125
620	905.4875	950.4875	670	906.7375	951.7375
621	905.5125	950.5125	671	906.7625	951.7625
622	905.5375	950.5375	672	906.7875	951.7875
623	905.5625	950.5625	673	906.8125	951.8125
624	905.5875	950.5875	674	906.8375	951.8375
625	905.6125	950.6125	675	906.8625	951.8625
626	905.6375	950.6375	676	906.8875	951.8875
627	905.6625	950.6625	677	906.9125	951.9125
628	905.6875	950.6875	678	906.9375	951.9375
629	905.7125	950.7125	679	906.9625	951.9625
630	905.7375	950.7375	680	906.9875	951.9875
631	905.7625	950.7625	681	907.0125	952.0125
632	905.7875	950.7875	682	907.0375	952.0375
633	905.8125	950.8125	683	907.0625	952.0625
634	905.8375	950.8375	684	907.0875	952.0875
635	905.8625	950.8625	685	907.1125	952.1125
636	905.8875	950.8875	686	907.1375	952.1375
637	905.9125	950.9125	687	907.1625	952.1625
638	905.9375	950.9375	688	907.1875	952.1875
639	905.9625	950.9625	689	907.2125	952.2125
640	905.9875	950.9875	690	907.2375	952.2375
641	906.0125	951.0125	691	907.2625	952.2625
642	906.0375	951.0375	692	907.2875	952.2875
643	906.0625	951.0625	693	907.3125	952.3125
644	906.0875	951.0875	694	907.3375	952.3375
645	906.1125	951.1125	695	907.3625	952.3625
646	906.1375	951.1375	696	907.3875	952.3875
647	906.1625	951.1625	697	907.4125	952.4125
648	906.1875	951.1875	698	907.4375	952.4375
649	906.2125	951.2125	699	907.4625	952.4625
650	906.2375	951.2375	700	907.4875	952.4875

Table C-1 TACS/E-TACS Cellular Channel Numbers and Frequencies (cont)

CHANNEL NUMBER	MOBILE TRANSMIT (MHz)	MOBILE RECEIVE (MHz)	CHANNEL NUMBER	MOBILE TRANSMIT (MHz)	MOBILE RECEIVE (MHz)
701	907.5125	952.5125	751	908.7625	953.7625
702	907.5375	952.5375	752	908.7875	953.7875
703	907.5625	952.5625	753	908.8125	953.8125
704	907.5875	952.5875	754	908.8375	953.8375
705	907.6125	952.6125	755	908.8625	953.8625
706	907.6375	952.6375	756	908.8875	953.8875
707	907.6625	952.6625	757	908.9125	953.9125
708	907.6875	952.6875	758	908.9375	953.9375
709	907.7125	952.7125	759	908.9625	953.9625
710	907.7375	952.7375	760	908.9875	953.9875
711	907.7625	952.7625	761	909.0125	954.0125
712	907.7875	952.7875	762	909.0375	954.0375
713	907.8125	952.8125	763	909.0625	954.0625
714	907.8375	952.8375	764	909.0875	954.0875
715	907.8625	952.8625	765	909.1125	954.1125
716	907.8875	952.8875	766	909.1375	954.1375
717	907.9125	952.9125	767	909.1625	954.1625
718	907.9375	952.9375	768	909.1875	954.1875
719	907.9625	952.9625	769	909.2125	954.2125
720	907.9875	952.9875	770	909.2375	954.2375
721	908.0125	953.0125	771	909.2625	954.2625
722	908.0375	953.0375	772	909.2875	954.2875
723	908.0625	953.0625	773	909.3125	954.3125
724	908.0875	953.0875	774	909.3375	954.3375
725	908.1125	953.1125	775	909.3625	954.3625
726	908.1375	953.1375	776	909.3875	954.3875
727	908.1625	953.1625	777	909.4125	954.4125
728	908.1875	953.1875	778	909.4375	954.4375
729	908.2125	953.2125	779	909.4625	954.4625
730	908.2375	953.2375	780	909.4875	954.4875
731	908.2625	953.2625	781	909.5125	954.5125
732	908.2875	953.2875	782	909.5375	954.5375
733	908.3125	953.3125	783	909.5625	954.5625
734	908.3375	953.3375	784	909.5875	954.5875
735	908.3625	953.3625	785	909.6125	954.6125
736	908.3875	953.3875	786	909.6375	954.6375
737	908.4125	953.4125	787	909.6625	954.6625
738	908.4375	953.4375	788	909.6875	954.6875
739	908.4625	953.4625	789	909.7125	954.7125
740	908.4875	953.4875	790	909.7375	954.7375
741	908.5125	953.5125	791	909.7625	954.7625
742	908.5375	953.5375	792	909.7875	954.7875
743	908.5625	953.5625	793	909.8125	954.8125
744	908.5875	953.5875	794	909.8375	954.8375
745	908.6125	953.6125	795	909.8625	954.8625
746	908.6375	953.6375	796	909.8875	954.8875
747	908.6625	953.6625	797	909.9125	954.9125
748	908.6875	953.6875	798	909.9375	954.9375
749	908.7125	953.7125	799	909.9625	954.9625
750	908.7375	953.7375	800	909.9875	954.9875

Table C-1 TACS/E-TACS Cellular Channel Numbers and Frequencies (cont)

<b>CHANNEL NUMBER</b>	<b>MOBILE TRANSMIT (MHz)</b>	<b>MOBILE RECEIVE (MHz)</b>	<b>CHANNEL NUMBER</b>	<b>MOBILE TRANSMIT (MHz)</b>	<b>MOBILE RECEIVE (MHz)</b>
801	910.0125	955.0125	851	911.2625	956.2625
802	910.0375	955.0375	852	911.2875	956.2875
803	910.0625	955.0625	853	911.3125	956.3125
804	910.0875	955.0875	854	911.3375	956.3375
805	910.1125	955.1125	855	911.3625	956.3625
806	910.1375	955.1375	856	911.3875	956.3875
807	910.1625	955.1625	857	911.4125	956.4125
808	910.1875	955.1875	858	911.4375	956.4375
809	910.2125	955.2125	859	911.4625	956.4625
810	910.2375	955.2375	860	911.4875	956.4875
811	910.2625	955.2625	861	911.5125	956.5125
812	910.2875	955.2875	862	911.5375	956.5375
813	910.3125	955.3125	863	911.5625	956.5625
814	910.3375	955.3375	864	911.5875	956.5875
815	910.3625	955.3625	865	911.6125	956.6125
816	910.3875	955.3875	866	911.6375	956.6375
817	910.4125	955.4125	867	911.6625	956.6625
818	910.4375	955.4375	868	911.6875	956.6875
819	910.4625	955.4625	869	911.7125	956.7125
820	910.4875	955.4875	870	911.7375	956.7375
821	910.5125	955.5125	871	911.7625	956.7625
822	910.5375	955.5375	872	911.7875	956.7875
823	910.5625	955.5625	873	911.8125	956.8125
824	910.5875	955.5875	874	911.8375	956.8375
825	910.6125	955.6125	875	911.8625	956.8625
826	910.6375	955.6375	876	911.8875	956.8875
827	910.6625	955.6625	877	911.9125	956.9125
828	910.6875	955.6875	878	911.9375	956.9375
829	910.7125	955.7125	879	911.9625	956.9625
830	910.7375	955.7375	880	911.9875	956.9875
831	910.7625	955.7625	881	912.0125	957.0125
832	910.7875	955.7875	882	912.0375	957.0375
833	910.8125	955.8125	883	912.0625	957.0625
834	910.8375	955.8375	884	912.0875	957.0875
835	910.8625	955.8625	885	912.1125	957.1125
836	910.8875	955.8875	886	912.1375	957.1375
837	910.9125	955.9125	887	912.1625	957.1625
838	910.9375	955.9375	888	912.1875	957.1875
839	910.9625	955.9625	889	912.2125	957.2125
840	910.9875	955.9875	890	912.2375	957.2375
841	911.0125	956.0125	891	912.2625	957.2625
842	911.0375	956.0375	892	912.2875	957.2875
843	911.0625	956.0625	893	912.3125	957.3125
844	911.0875	956.0875	894	912.3375	957.3375
845	911.1125	956.1125	895	912.3625	957.3625
846	911.1375	956.1375	896	912.3875	957.3875
847	911.1625	956.1625	897	912.4125	957.4125
848	911.1875	956.1875	898	912.4375	957.4375
849	911.2125	956.2125	899	912.4625	957.4625
850	911.2375	956.2375	900	912.4875	957.4875

Table C-1 TACS/E-TACS Cellular Channel Numbers and Frequencies (cont)

<b>CHANNEL NUMBER</b>	<b>MOBILE TRANSMIT (MHz)</b>	<b>MOBILE RECEIVE (MHz)</b>	<b>CHANNEL NUMBER</b>	<b>MOBILE TRANSMIT (MHz)</b>	<b>MOBILE RECEIVE (MHz)</b>
901	912.5125	957.5125	951	913.7625	958.7625
902	912.5375	957.5375	952	913.7875	958.7875
903	912.5625	957.5625	953	913.8125	958.8125
904	912.5875	957.5875	954	913.8375	958.8375
905	912.6125	957.6125	955	913.8625	958.8625
906	912.6375	957.6375	956	913.8875	958.8875
907	912.6625	957.6625	957	913.9125	958.9125
908	912.6875	957.6875	958	913.9375	958.9375
909	912.7125	957.7125	959	913.9625	958.9625
910	912.7375	957.7375	960	913.9875	958.9875
911	912.7625	957.7625	961	914.0125	959.0125
912	912.7875	957.7875	962	914.0375	959.0375
913	912.8125	957.8125	963	914.0625	959.0625
914	912.8375	957.8375	964	914.0875	959.0875
915	912.8625	957.8625	965	914.1125	959.1125
916	912.8875	957.8875	966	914.1375	959.1375
917	912.9125	957.9125	967	914.1625	959.1625
918	912.9375	957.9375	968	914.1875	959.1875
919	912.9625	957.9625	969	914.2125	959.2125
920	912.9875	957.9875	970	914.2375	959.2375
921	913.0125	958.0125	971	914.2625	959.2625
922	913.0375	958.0375	972	914.2875	959.2875
923	913.0625	958.0625	973	914.3125	959.3125
924	913.0875	958.0875	974	914.3375	959.3375
925	913.1125	958.1125	975	914.3625	959.3625
926	913.1375	958.1375	976	914.3875	959.3875
927	913.1625	958.1625	977	914.4125	959.4125
928	913.1875	958.1875	978	914.4375	959.4375
929	913.2125	958.2125	979	914.4625	959.4625
930	913.2375	958.2375	980	914.4875	959.4875
931	913.2625	958.2625	981	914.5125	959.5125
932	913.2875	958.2875	982	914.5375	959.5375
933	913.3125	958.3125	983	914.5625	959.5625
934	913.3375	958.3375	984	914.5875	959.5875
935	913.3625	958.3625	985	914.6125	959.6125
936	913.3875	958.3875	986	914.6375	959.6375
937	913.4125	958.4125	987	914.6625	959.6625
938	913.4375	958.4375	988	914.6875	959.6875
939	913.4625	958.4625	989	914.7125	959.7125
940	913.4875	958.4875	990	914.7375	959.7375
941	913.5125	958.5125	991	914.7625	959.7625
942	913.5375	958.5375	992	914.7875	959.7875
943	913.5625	958.5625	993	914.8125	959.8125
944	913.5875	958.5875	994	914.8375	959.8375
945	913.6125	958.6125	995	914.8625	959.8625
946	913.6375	958.6375	996	914.8875	959.8875
947	913.6625	958.6625	997	914.9125	959.9125
948	913.6875	958.6875	998	914.9375	959.9375
949	913.7125	958.7125	999	914.9625	959.9625
950	913.7375	958.7375	1000	914.9875	959.9875

Table C-1 TACS/E-TACS Cellular Channel Numbers and Frequencies (cont)

CHANNEL NUMBER	MOBILE TRANSMIT (MHz)	MOBILE RECEIVE (MHz)	CHANNEL NUMBER	MOBILE TRANSMIT (MHz)	MOBILE RECEIVE (MHz)
			1351	872.5625	917.5625
			1352	872.5875	917.5875
			1353	872.6125	917.6125
			1354	872.6375	917.6375
			1355	872.6625	917.6625
			1356	872.6875	917.6875
			1357	872.7125	917.7125
			1358	872.7375	917.7375
			1359	872.7625	917.7625
			1360	872.7875	917.7875
			1361	872.8125	917.8125
			1362	872.8375	917.8375
			1363	872.8625	917.8625
			1364	872.8875	917.8875
			1365	872.9125	917.9125
			1366	872.9375	917.9375
			1367	872.9625	917.9625
			1368	872.9875	917.9875
			1369	873.0125	918.0125
			1370	873.0375	918.0375
			1371	873.0625	918.0625
			1372	873.0875	918.0875
			1373	873.1125	918.1125
			1374	873.1375	918.1375
			1375	873.1625	918.1625
			1376	873.1875	918.1875
			1377	873.2125	918.2125
			1378	873.2375	918.2375
			1379	873.2625	918.2625
			1380	873.2875	918.2875
			1381	873.3125	918.3125
			1382	873.3375	918.3375
			1383	873.3625	918.3625
			1384	873.3875	918.3875
			1385	873.4125	918.4125
			1386	873.4375	918.4375
			1387	873.4625	918.4625
			1388	873.4875	918.4875
			1389	873.5125	918.5125
			1390	873.5375	918.5375
			1391	873.5625	918.5625
			1392	873.5875	918.5875
			1393	873.6125	918.6125
			1394	873.6375	918.6375
			1395	873.6625	918.6625
			1396	873.6875	918.6875
			1397	873.7125	918.7125
			1398	873.7375	918.7375
			1399	873.7625	918.7625
			1400	873.7875	918.7875
1329	872.0125	917.0125			
1330	872.0375	917.0375			
1331	872.0625	917.0625			
1332	872.0875	917.0875			
1333	872.1125	917.1125			
1334	872.1375	917.1375			
1335	872.1625	917.1625			
1336	872.1875	917.1875			
1337	872.2125	917.2125			
1338	872.2375	917.2375			
1339	872.2625	917.2625			
1340	872.2875	917.2875			
1341	872.3125	917.3125			
1342	872.3375	917.3375			
1343	872.3625	917.3625			
1344	872.3875	917.3875			
1345	872.4125	917.4125			
1346	872.4375	917.4375			
1347	872.4625	917.4625			
1348	872.4875	917.4875			
1349	872.5125	917.5125			
1350	872.5375	917.5375			

↑  
TACS

E-TACS  
↓

Table C-1 TACS/E-TACS Cellular Channel Numbers and Frequencies (cont)



CHANNEL NUMBER	MOBILE TRANSMIT (MHz)	MOBILE RECEIVE (MHz)	CHANNEL NUMBER	MOBILE TRANSMIT (MHz)	MOBILE RECEIVE (MHz)
1401	873.8125	918.8125	1451	875.0625	920.0625
1402	873.8375	918.8375	1452	875.0875	920.0875
1403	873.8625	918.8625	1453	875.1125	920.1125
1404	873.8875	918.8875	1454	875.1375	920.1375
1405	873.9125	918.9125	1455	875.1625	920.1625
1406	873.9375	918.9375	1456	875.1875	920.1875
1407	873.9625	918.9625	1457	875.2125	920.2125
1408	873.9875	918.9875	1458	875.2375	920.2375
1409	874.0125	919.0125	1459	875.2625	920.2625
1410	874.0375	919.0375	1460	875.2875	920.2875
1411	874.0625	919.0625	1461	875.3125	920.3125
1412	874.0875	919.0875	1462	875.3375	920.3375
1413	874.1125	919.1125	1463	875.3625	920.3625
1414	874.1375	919.1375	1464	875.3875	920.3875
1415	874.1625	919.1625	1465	875.4125	920.4125
1416	874.1875	919.1875	1466	875.4375	920.4375
1417	874.2125	919.2125	1467	875.4625	920.4625
1418	874.2375	919.2375	1468	875.4875	920.4875
1419	874.2625	919.2625	1469	875.5125	920.5125
1420	874.2875	919.2875	1470	875.5375	920.5375
1421	874.3125	919.3125	1471	875.5625	920.5625
1422	874.3375	919.3375	1472	875.5875	920.5875
1423	874.3625	919.3625	1473	875.6125	920.6125
1424	874.3875	919.3875	1474	875.6375	920.6375
1425	874.4125	919.4125	1475	875.6625	920.6625
1426	874.4375	919.4375	1476	875.6875	920.6875
1427	874.4625	919.4625	1477	875.7125	920.7125
1428	874.4875	919.4875	1478	875.7375	920.7375
1429	874.5125	919.5125	1479	875.7625	920.7625
1430	874.5375	919.5375	1480	875.7875	920.7875
1431	874.5625	919.5625	1481	875.8125	920.8125
1432	874.5875	919.5875	1482	875.8375	920.8375
1433	874.6125	919.6125	1483	875.8625	920.8625
1434	874.6375	919.6375	1484	875.8875	920.8875
1435	874.6625	919.6625	1485	875.9125	920.9125
1436	874.6875	919.6875	1486	875.9375	920.9375
1437	874.7125	919.7125	1487	875.9625	920.9625
1438	874.7375	919.7375	1488	875.9875	920.9875
1439	874.7625	919.7625	1489	876.0125	921.0125
1440	874.7875	919.7875	1490	876.0375	921.0375
1441	874.8125	919.8125	1491	876.0625	921.0625
1442	874.8375	919.8375	1492	876.0875	921.0875
1443	874.8625	919.8625	1493	876.1125	921.1125
1444	874.8875	919.8875	1494	876.1375	921.1375
1445	874.9125	919.9125	1495	876.1625	921.1625
1446	874.9375	919.9375	1496	876.1875	921.1875
1447	874.9625	919.9625	1497	876.2125	921.2125
1448	874.9875	919.9875	1498	876.2375	921.2375
1449	875.0125	920.0125	1499	876.2625	921.2625
1450	875.0375	920.0375	1500	876.2875	921.2875

Table C-1 TACS/E-TACS Cellular Channel Numbers and Frequencies (cont)

<b>CHANNEL NUMBER</b>	<b>MOBILE TRANSMIT (MHz)</b>	<b>MOBILE RECEIVE (MHz)</b>	<b>CHANNEL NUMBER</b>	<b>MOBILE TRANSMIT (MHz)</b>	<b>MOBILE RECEIVE (MHz)</b>
1501	876.3125	921.3125	1551	877.5625	922.5625
1502	876.3375	921.3375	1552	877.5875	922.5875
1503	876.3625	921.3625	1553	877.6125	922.6125
1504	876.3875	921.3875	1554	877.6375	922.6375
1505	876.4125	921.4125	1555	877.6625	922.6625
1506	876.4375	921.4375	1556	877.6875	922.6875
1507	876.4625	921.4625	1557	877.7125	922.7125
1508	876.4875	921.4875	1558	877.7375	922.7375
1509	876.5125	921.5125	1559	877.7625	922.7625
1510	876.5375	921.5375	1560	877.7875	922.7875
1511	876.5625	921.5625	1561	877.8125	922.8125
1512	876.5875	921.5875	1562	877.8375	922.8375
1513	876.6125	921.6125	1563	877.8625	922.8625
1514	876.6375	921.6375	1564	877.8875	922.8875
1515	876.6625	921.6625	1565	877.9125	922.9125
1516	876.6875	921.6875	1566	877.9375	922.9375
1517	876.7125	921.7125	1567	877.9625	922.9625
1518	876.7375	921.7375	1568	877.9875	922.9875
1519	876.7625	921.7625	1569	878.0125	923.0125
1520	876.7875	921.7875	1570	878.0375	923.0375
1521	876.8125	921.8125	1571	878.0625	923.0625
1522	876.8375	921.8375	1572	878.0875	923.0875
1523	876.8625	921.8625	1573	878.1125	923.1125
1524	876.8875	921.8875	1574	878.1375	923.1375
1525	876.9125	921.9125	1575	878.1625	923.1625
1526	876.9375	921.9375	1576	878.1875	923.1875
1527	876.9625	921.9625	1577	878.2125	923.2125
1528	876.9875	921.9875	1578	878.2375	923.2375
1529	877.0125	922.0125	1579	878.2625	923.2625
1530	877.0375	922.0375	1580	878.2875	923.2875
1531	877.0625	922.0625	1581	878.3125	923.3125
1532	877.0875	922.0875	1582	878.3375	923.3375
1533	877.1125	922.1125	1583	878.3625	923.3625
1534	877.1375	922.1375	1584	878.3875	923.3875
1535	877.1625	922.1625	1585	878.4125	923.4125
1536	877.1875	922.1875	1586	878.4375	923.4375
1537	877.2125	922.2125	1587	878.4625	923.4625
1538	877.2375	922.2375	1588	878.4875	923.4875
1539	877.2625	922.2625	1589	878.5125	923.5125
1540	877.2875	922.2875	1590	878.5375	923.5375
1541	877.3125	922.3125	1591	878.5625	923.5625
1542	877.3375	922.3375	1592	878.5875	923.5875
1543	877.3625	922.3625	1593	878.6125	923.6125
1544	877.3875	922.3875	1594	878.6375	923.6375
1545	877.4125	922.4125	1595	878.6625	923.6625
1546	877.4375	922.4375	1596	878.6875	923.6875
1547	877.4625	922.4625	1597	878.7125	923.7125
1548	877.4875	922.4875	1598	878.7375	923.7375
1549	877.5125	922.5125	1599	878.7625	923.7625
1550	877.5375	922.5375	1600	878.7875	923.7875

Table C-1 TACS/E-TACS Cellular Channel Numbers and Frequencies (cont)

CHANNEL NUMBER	MOBILE TRANSMIT (MHz)	MOBILE RECEIVE (MHz)	CHANNEL NUMBER	MOBILE TRANSMIT (MHz)	MOBILE RECEIVE (MHz)
1601	878.8125	923.8125	1651	880.0625	925.0625
1602	878.8375	923.8375	1652	880.0875	925.0875
1603	878.8625	923.8625	1653	880.1125	925.1125
1604	878.8875	923.8875	1654	880.1375	925.1375
1605	878.9125	923.9125	1655	880.1625	925.1625
1606	878.9375	923.9375	1656	880.1875	925.1875
1607	878.9625	923.9625	1657	880.2125	925.2125
1608	878.9875	923.9875	1658	880.2375	925.2375
1609	879.0125	924.0125	1659	880.2625	925.2625
1610	879.0375	924.0375	1660	880.2875	925.2875
1611	879.0625	924.0625	1661	880.3125	925.3125
1612	879.0875	924.0875	1662	880.3375	925.3375
1613	879.1125	924.1125	1663	880.3625	925.3625
1614	879.1375	924.1375	1664	880.3875	925.3875
1615	879.1625	924.1625	1665	880.4125	925.4125
1616	879.1875	924.1875	1666	880.4375	925.4375
1617	879.2125	924.2125	1667	880.4625	925.4625
1618	879.2375	924.2375	1668	880.4875	925.4875
1619	879.2625	924.2625	1669	880.5125	925.5125
1620	879.2875	924.2875	1670	880.5375	925.5375
1621	879.3125	924.3125	1671	880.5625	925.5625
1622	879.3375	924.3375	1672	880.5875	925.5875
1623	879.3625	924.3625	1673	880.6125	925.6125
1624	879.3875	924.3875	1674	880.6375	925.6375
1625	879.4125	924.4125	1675	880.6625	925.6625
1626	879.4375	924.4375	1676	880.6875	925.6875
1627	879.4625	924.4625	1677	880.7125	925.7125
1628	879.4875	924.4875	1678	880.7375	925.7375
1629	879.5125	924.5125	1679	880.7625	925.7625
1630	879.5375	924.5375	1680	880.7875	925.7875
1631	879.5625	924.5625	1681	880.8125	925.8125
1632	879.5875	924.5875	1682	880.8375	925.8375
1633	879.6125	924.6125	1683	880.8625	925.8625
1634	879.6375	924.6375	1684	880.8875	925.8875
1635	879.6625	924.6625	1685	880.9125	925.9125
1636	879.6875	924.6875	1686	880.9375	925.9375
1637	879.7125	924.7125	1687	880.9625	925.9625
1638	879.7375	924.7375	1688	880.9875	925.9875
1639	879.7625	924.7625	1689	881.0125	926.0125
1640	879.7875	924.7875	1690	881.0375	926.0375
1641	879.8125	924.8125	1691	881.0625	926.0625
1642	879.8375	924.8375	1692	881.0875	926.0875
1643	879.8625	924.8625	1693	881.1125	926.1125
1644	879.8875	924.8875	1694	881.1375	926.1375
1645	879.9125	924.9125	1695	881.1625	926.1625
1646	879.9375	924.9375	1696	881.1875	926.1875
1647	879.9625	924.9625	1697	881.2125	926.2125
1648	879.9875	924.9875	1698	881.2375	926.2375
1649	880.0125	925.0125	1699	881.2625	926.2625
1650	880.0375	925.0375	1700	881.2875	926.2875

Table C-1 TACS/E-TACS Cellular Channel Numbers and Frequencies (cont)

<b>CHANNEL NUMBER</b>	<b>MOBILE TRANSMIT (MHz)</b>	<b>MOBILE RECEIVE (MHz)</b>	<b>CHANNEL NUMBER</b>	<b>MOBILE TRANSMIT (MHz)</b>	<b>MOBILE RECEIVE (MHz)</b>
1701	881.3125	926.3125	1751	882.5625	927.5625
1702	881.3375	926.3375	1752	882.5875	927.5875
1703	881.3625	926.3625	1753	882.6125	927.6125
1704	881.3875	926.3875	1754	882.6375	927.6375
1705	881.4125	926.4125	1755	882.6625	927.6625
1706	881.4375	926.4375	1756	882.6875	927.6875
1707	881.4625	926.4625	1757	882.7125	927.7125
1708	881.4875	926.4875	1758	882.7375	927.7375
1709	881.5125	926.5125	1759	882.7625	927.7625
1710	881.5375	926.5375	1760	882.7875	927.7875
1711	881.5625	926.5625	1761	882.8125	927.8125
1712	881.5875	926.5875	1762	882.8375	927.8375
1713	881.6125	926.6125	1763	882.8625	927.8625
1714	881.6375	926.6375	1764	882.8875	927.8875
1715	881.6625	926.6625	1765	882.9125	927.9125
1716	881.6875	926.6875	1766	882.9375	927.9375
1717	881.7125	926.7125	1767	882.9625	927.9625
1718	881.7375	926.7375	1768	882.9875	927.9875
1719	881.7625	926.7625	1769	883.0125	928.0125
1720	881.7875	926.7875	1770	883.0375	928.0375
1721	881.8125	926.8125	1771	883.0625	928.0625
1722	881.8375	926.8375	1772	883.0875	928.0875
1723	881.8625	926.8625	1773	883.1125	928.1125
1724	881.8875	926.8875	1774	883.1375	928.1375
1725	881.9125	926.9125	1775	883.1625	928.1625
1726	881.9375	926.9375	1776	883.1875	928.1875
1727	881.9625	926.9625	1777	883.2125	928.2125
1728	881.9875	926.9875	1778	883.2375	928.2375
1729	882.0125	927.0125	1779	883.2625	928.2625
1730	882.0375	927.0375	1780	883.2875	928.2875
1731	882.0625	927.0625	1781	883.3125	928.3125
1732	882.0875	927.0875	1782	883.3375	928.3375
1733	882.1125	927.1125	1783	883.3625	928.3625
1734	882.1375	927.1375	1784	883.3875	928.3875
1735	882.1625	927.1625	1785	883.4125	928.4125
1736	882.1875	927.1875	1786	883.4375	928.4375
1737	882.2125	927.2125	1787	883.4625	928.4625
1738	882.2375	927.2375	1788	883.4875	928.4875
1739	882.2625	927.2625	1789	883.5125	928.5125
1740	882.2875	927.2875	1790	883.5375	928.5375
1741	882.3125	927.3125	1791	883.5625	928.5625
1742	882.3375	927.3375	1792	883.5875	928.5875
1743	882.3625	927.3625	1793	883.6125	928.6125
1744	882.3875	927.3875	1794	883.6375	928.6375
1745	882.4125	927.4125	1795	883.6625	928.6625
1746	882.4375	927.4375	1796	883.6875	928.6875
1747	882.4625	927.4625	1797	883.7125	928.7125
1748	882.4875	927.4875	1798	883.7375	928.7375
1749	882.5125	927.5125	1799	883.7625	928.7625
1750	882.5375	927.5375	1800	883.7875	928.7875

Table C-1 TACS/E-TACS Cellular Channel Numbers and Frequencies (cont)

CHANNEL NUMBER	MOBILE TRANSMIT (MHz)	MOBILE RECEIVE (MHz)	CHANNEL NUMBER	MOBILE TRANSMIT (MHz)	MOBILE RECEIVE (MHz)
1801	883.8125	928.8125	1851	885.0625	930.0625
1802	883.8375	928.8375	1852	885.0875	930.0875
1803	883.8625	928.8625	1853	885.1125	930.1125
1804	883.8875	928.8875	1854	885.1875	930.1875
1805	883.9125	928.9125	1855	885.1625	930.1625
1806	883.9375	928.9375	1856	885.1875	930.1875
1807	883.9625	928.9625	1857	885.2125	930.2125
1808	883.9875	928.9875	1858	885.2375	930.2375
1809	884.0125	929.0125	1859	885.2625	930.2625
1810	884.0375	929.0375	1860	885.2875	930.2875
1811	884.0625	929.0625	1861	885.3125	930.3125
1812	884.0875	929.0875	1862	885.3375	930.3375
1813	884.1125	929.1125	1863	885.3625	930.3625
1814	884.1375	929.1375	1864	885.3875	930.3875
1815	884.1625	929.1625	1865	885.4125	930.4125
1816	884.1875	929.1875	1866	885.4375	930.4375
1817	884.2125	929.2125	1867	885.4625	930.4625
1818	884.2375	929.2375	1868	885.4875	930.4875
1819	884.2625	929.2625	1869	885.5125	930.5125
1820	884.2875	929.2875	1870	885.5375	930.5375
1821	884.3125	929.3125	1871	885.5625	930.5625
1822	884.3375	929.3375	1872	885.5875	930.5875
1823	884.3625	929.3625	1873	885.6125	930.6125
1824	884.3875	929.3875	1874	885.6375	930.6375
1825	884.4125	929.4125	1875	885.6625	930.6625
1826	884.4375	929.4375	1876	885.6875	930.6875
1827	884.4625	929.4625	1877	885.7125	930.7125
1828	884.4875	929.4875	1878	885.7375	930.7375
1829	884.5125	929.5125	1879	885.7625	930.7625
1830	884.5375	929.5375	1880	885.7875	930.7875
1831	884.5625	929.5625	1881	885.8125	930.8125
1832	884.5875	929.5875	1882	885.8375	930.8375
1833	884.6125	929.6125	1883	885.8625	930.8625
1834	884.6375	929.6375	1884	885.8875	930.8875
1835	884.6625	929.6625	1885	885.9125	930.9125
1836	884.6875	929.6875	1886	885.9375	930.9375
1837	884.7125	929.7125	1887	885.9625	930.9625
1838	884.7375	929.7375	1888	885.9875	930.9875
1839	884.7625	929.7625	1889	886.0125	931.0125
1840	884.7875	929.7875	1890	886.0375	931.0375
1841	884.8125	929.8125	1891	886.0625	931.0625
1842	884.8375	929.8375	1892	886.0875	931.0875
1843	884.8625	929.8625	1893	886.1125	931.1125
1844	884.8875	929.8875	1894	886.1875	931.1875
1845	884.9125	929.9125	1895	886.1625	931.1625
1846	884.9375	929.9375	1896	886.1875	931.1875
1847	884.9625	929.9625	1897	886.2125	931.2125
1848	884.9875	929.9875	1898	886.2375	931.2375
1849	885.0125	930.0125	1899	886.2625	931.2625
1850	885.0375	930.0375	1900	886.2875	931.2875

Table C-1 TACS/E-TACS Cellular Channel Numbers and Frequencies (cont)

<b>CHANNEL NUMBER</b>	<b>MOBILE TRANSMIT (MHz)</b>	<b>MOBILE RECEIVE (MHz)</b>	<b>CHANNEL NUMBER</b>	<b>MOBILE TRANSMIT (MHz)</b>	<b>MOBILE RECEIVE (MHz)</b>
1901	886.3125	931.3125	1951	887.5625	932.5625
1902	886.3375	931.3375	1952	887.5875	932.5875
1903	886.3625	931.3625	1953	887.6125	932.6125
1904	886.3875	931.3875	1954	887.6375	932.6375
1905	886.4125	931.4125	1955	887.6625	932.6625
1906	886.4375	931.4375	1956	887.6875	932.6875
1907	886.4625	931.4625	1957	887.7125	932.7125
1908	886.4875	931.4875	1958	887.7375	932.7375
1909	886.5125	931.5125	1959	887.7625	932.7625
1910	886.5375	931.5375	1960	887.7875	932.7875
1911	886.5625	931.5625	1961	887.8125	932.8125
1912	886.5875	931.5875	1962	887.8375	932.8375
1913	886.6125	931.6125	1963	887.8625	932.8625
1914	886.6375	931.6375	1964	887.8875	932.8875
1915	886.6625	931.6625	1965	887.9125	932.9125
1916	886.6875	931.6875	1966	887.9375	932.9375
1917	886.7125	931.7125	1967	887.9625	932.9625
1918	886.7375	931.7375	1968	887.9875	932.9875
1919	886.7625	931.7625	1969	888.0125	933.0125
1920	886.7875	931.7875	1970	888.0375	933.0375
1921	886.8125	931.8125	1971	888.0625	933.0625
1922	886.8375	931.8375	1972	888.0875	933.0875
1923	886.8625	931.8625	1973	888.1125	933.1125
1924	886.8875	931.8875	1974	888.1975	933.1975
1925	886.9125	931.9125	1975	888.1625	933.1625
1926	886.9375	931.9375	1976	888.1975	933.1975
1927	886.9625	931.9625	1977	888.2125	933.2125
1928	886.9875	931.9875	1978	888.2375	933.2375
1929	887.0125	932.0125	1979	888.2625	933.2625
1930	887.0375	932.0375	1980	888.2875	933.2875
1931	887.0625	932.0625	1981	888.3125	933.3125
1932	887.0875	932.0875	1982	888.3375	933.3375
1933	887.1125	932.1125	1983	888.3625	933.3625
1934	887.1975	932.1975	1984	888.3875	933.3875
1935	887.1625	932.1625	1985	888.4125	933.4125
1936	887.1975	932.1975	1986	888.4375	933.4375
1937	887.2125	932.2125	1987	888.4625	933.4625
1938	887.2375	932.2375	1988	888.4875	933.4875
1939	887.2625	932.2625	1989	888.5125	933.5125
1940	887.2875	932.2875	1990	888.5375	933.5375
1941	887.3125	932.3125	1991	888.5625	933.5625
1942	887.3375	932.3375	1992	888.5875	933.5875
1943	887.3625	932.3625	1993	888.6125	933.6125
1944	887.3875	932.3875	1994	888.6375	933.6375
1945	887.4125	932.4125	1995	888.6625	933.6625
1946	887.4375	932.4375	1996	888.6875	933.6875
1947	887.4625	932.4625	1997	888.7125	933.7125
1948	887.4875	932.4875	1998	888.7375	933.7375
1949	887.5125	932.5125	1999	888.7625	933.7625
1950	887.5375	932.5375	2000	888.7875	933.7875

Table C-1 TACS/E-TACS Cellular Channel Numbers and Frequencies (cont)

<b>CHANNEL NUMBER</b>	<b>MOBILE TRANSMIT (MHz)</b>	<b>MOBILE RECEIVE (MHz)</b>
2001	888.8125	933.8125
2002	888.8375	933.8375
2003	888.8625	933.8625
2004	888.8875	933.8875
2005	888.9125	933.9125
2006	888.9375	933.9375
2007	888.9625	933.9625
2008	888.9875	933.9875
2009	889.0125	934.0125
2010	889.0375	934.0375
2011	889.0625	934.0625
2012	889.0875	934.0875
2013	889.1125	934.1125
2014	889.2075	934.2075
2015	889.1625	934.1625
2016	889.2075	934.2075
2017	889.2125	934.2125
2018	889.2375	934.2375
2019	889.2625	934.2625
2020	889.2875	934.2875
2021	889.3125	934.3125
2022	889.3375	934.3375
2023	889.3625	934.3625
2024	889.3875	934.3875
2025	889.4125	934.4125
2026	889.4375	934.4375
2027	889.4625	934.4625
2028	889.4875	934.4875
2029	889.5125	934.5125
2030	889.5375	934.5375
2031	889.5625	934.5625
2032	889.5875	934.5875
2033	889.6125	934.6125
2034	889.6375	934.6375
2035	889.6625	934.6625
2036	889.6875	934.6875
2037	889.7125	934.7125
2038	889.7375	934.7375
2039	889.7625	934.7625
2040	889.7875	934.7875
2041	889.8125	934.8125
2042	889.8375	934.8375
2043	889.8625	934.8625
2044	889.8875	934.8875
2045	889.9125	934.9125
2046	889.9375	934.9375
2047	889.9625	934.9625

Table C-1 TACS/E-TACS Cellular Channel Numbers and Frequencies (cont)

## APPENDIX D - ABBREVIATIONS

A		D	
A	Ampere	DAC	Digital to Analog Converter
ac	Alternating Current	DCS	Digital Coded Squelch
AF	Audio Frequency	dB	Decibels
A Freq	Audio Frequency	dBm	Decibels relative to 1 milli-watt
AGC	Automatic Gain Control	dc	Direct Current
AM	Amplitude Modulation	DCS	Digital Coded Squelch Codes
amp	Ampere	Demod Audio	Demodulated Audio
ANLZ	Analyzer	Dev	Deviation
ANSI	American National Standards Institute	Disp	Display
ANT	Antenna	Dist	Distortion
AR	Autorange	div	Division(s)
ASCII	American National Standard Code for Information Interchange	DMM	Digital Multimeter
Atten	Attenuation	DPL	Duplex
Auto	Automatic	DPLX	Duplex
AUX	Auxiliary	DTMF	Dual Tone Multi-Frequency
		Dup	Duplex
B		E	
BFO	Beat Frequency Oscillator	ERR	Error
BER	Bit Error Rate	ESC	Escape
bps	Bits per second	ESD	Electrostatic discharge
C		E-TACS	Enhanced Total Access Communications System
Cbl Flt	Cable Fault	EXT MOD	External
CCH	Control Channel		
ccw	Counterclockwise		
Cont	Continued		
CW	Continuous Wave		
C Wt	C-Weight		



	<b>F</b>		<b>L</b>
Fig	Figure	L-lim	Lower Limit
FM	Frequency Modulation	Lmt	Limit
Folw	Follow	lvl	Level
freq	Frequency		
Func	Function		<b>M</b>
Func Gen	Function Generator	M-Freq	Audio Frequency
	<b>G</b>	MHz	Megahertz (1000000 Hertz)
G-Scan	RF Generator Scan	MIC	Microphone Source
Gen	Generator	Mkr	Marker
GND	Ground	mod	Modulation
GPIO	General Purpose Interface Bus	modul	Modulation
	<b>H</b>	ms	Millisecond
Hz	Hertz	MTRS	Meters
Hex	Hexadecimal	mV	Millivolt
Horiz	Horizontal	mW	Milliwatt
	<b>I</b>		<b>N</b>
Id	Identification	N/A	Not Applicable
IF	Intermediate Frequency	Neg	Negative
IEEE	Institute of Electrical and Electronic Engineers	NADC	North American Digital Cellular
I/O	Input/Output	NADC-HY	Hyperband (1900 MHz)
	<b>K</b>	NADC-U4	NT400 (450 MHz)
kbps	Kilobits per second	NADC-U8	AMPS (800 MHz)
kHz	Kilohertz (1000 Hertz)		<b>O</b>
		OFST	Offset Frequency

<b>P</b>		<b>T</b>	
PH	Peak Hold	TERM	Terminal
PM	Phase Modulation	T Freq	Duplex Transmitter Frequency
Pos	Positive	Tone Rem	Tone Remote
PROG	Program	Trig	Trigger
PWR	Power (switch)	Trk	Tracking
<b>R</b>		Tx	Duplex Transmitter (Receiving) Frequency
RCL	Recall	<b>U</b>	
Rcvr	Receiver	U-lim	Upper Limit
Recap	Recapture	UUT	Unit Under Test
Ref	Reference	<b>V</b>	
Res	Resolution	V	Volt
Ret	Return	VAC	Alternating current voltage
RF	Radio Frequency	VChan	Voice Channel
RF Pwr Lvl	RF Power Level	Vdc	Direct current voltage
R freq	Receiver Frequency	Vert	Vertical
RMS	Root Mean Square	VOL	Volume
Rx	Duplex Receiver (Transmitting) Frequency	VRMS	Voltage Root Mean Square
<b>S</b>		<b>W</b>	
SCRN	Screen	W	Watt
SCSI	Small Computer System Interface		
sec	Second		
SGL	Single		
SIG	Signal Strength		
SQLCH	Squelch		

# APPENDIX E - REPACKING FOR SHIPPING

## E-1 SHIPPING INFORMATION

IFR Test Sets returned to factory for calibration, service or repair must be repackaged and shipped subject to the following conditions:

### E-1-1 AUTHORIZATION

Do not return any products to factory without authorization from IFR Customer Service Department.

CONTACT: IFR Systems, Inc.  
Customer Service Dept.  
10200 West York Street  
Wichita, Kansas 67215-8935

Telephone: 800-835-2350  
FAX: 316-524-2623

### E-1-2 TAGGING TEST SETS

All test sets must be tagged with:

- Owner's identification and address.
- Nature of service or repair required.
- Model No. and Serial No.

### E-1-3 SHIPPING CONTAINERS

Test Sets must be repackaged in original shipping containers using IFR packing materials. If original shipping containers and materials are not available, contact IFR Customer Service Department for shipping instructions.

### E-1-4 FREIGHT COSTS

All freight costs on non-warranty shipments are assumed by the customer. (See "Warranty Packet" for freight charge policy on warranty claims.)

## E-2 REPACKING PROCEDURE (FIGURE E-1)

- Make sure bottom packing mold is seated on floor of shipping container.
- Adjust handle to lay unlocked against Test Set as shown.
- Place Elastic Retainer around Test Set to secure handle.
- Carefully wrap Test Set with polyethylene sheeting.
- Place Test Set into shipping container, making sure Test Set is securely seated in bottom packing mold.
- Place top packing mold over top of Test Set and press down until mold rests solidly on bottom packing mold.

- Close shipping container lids and seal with shipping tape or an industrial stapler. Tie all sides of container with break resistant rope, twine or equivalent.

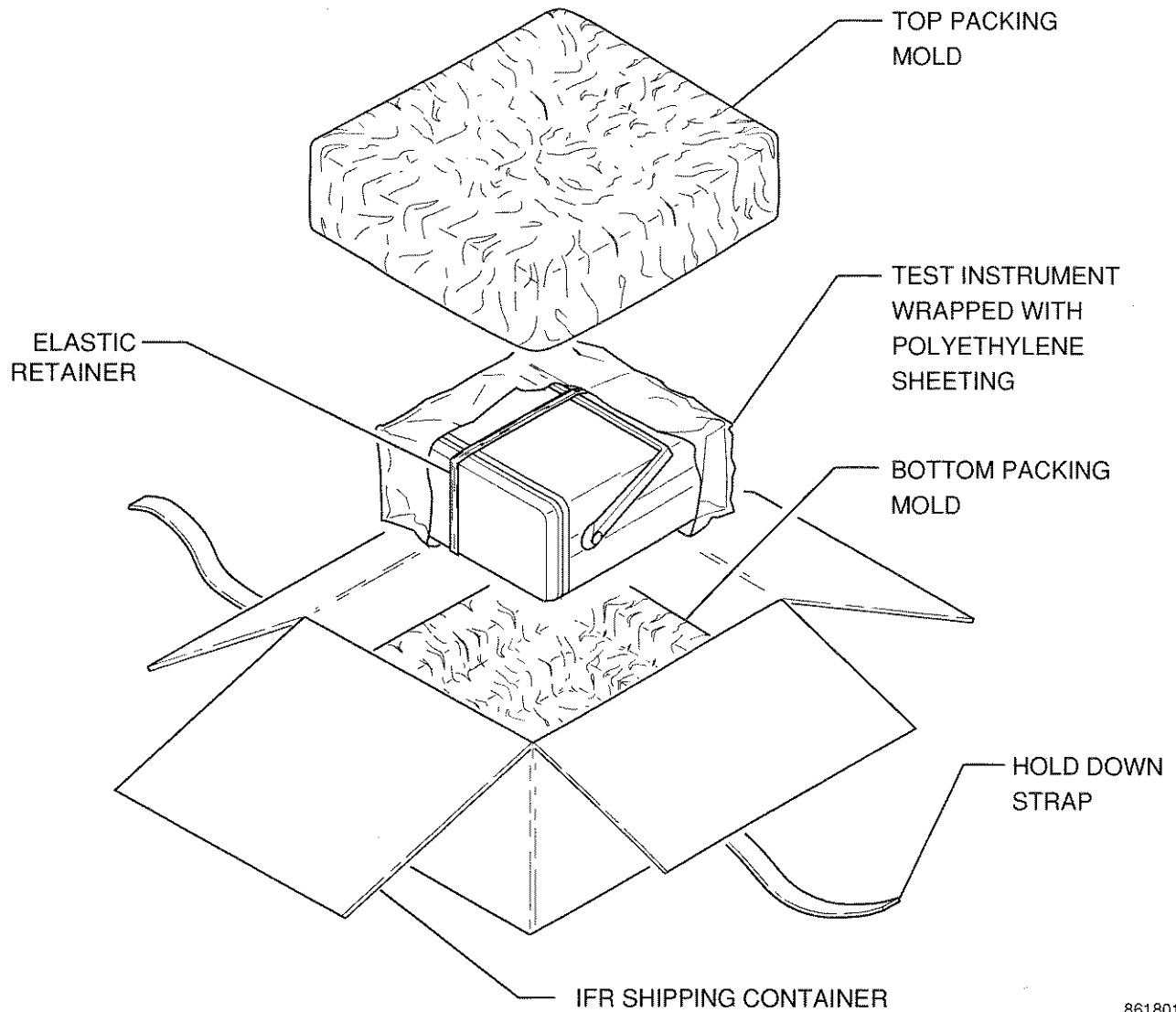

8618018

Figure E-1 Repacking for Shipment

# INDEX

## A (cont)

2805 Signaling Format	
Duplex Receiver	
Generating	4-84
Selection	4-90
Example, Generating 2805 Code	4-28
RF Generator	
Generating	4-7
Selection	4-13

## A

Abbreviations	D-1
AF Generator	
AF Level Meter (RMS)	
Operation	4-151
Operation Screen	3-218
Examples	
Generating AF Tone	4-104
Generating Tone Remote Code	4-104
Frequency Scan	
Menu	3-128
Operation	4-102
Menu	3-126
Operation	4-99
Operation Screen and Soft Function Keys	3-123
Specifications	1-9
AF Meter	
Menu	3-157
Operation	4-119
Operation Screen	3-154
Specifications	1-9
AM Modulation Meter	
Menu	3-177
Operation	4-128
Operation Screen	3-174
Specifications	1-12
AMPS/NAMPS	
Cell Site Monitor	7-1
Cellular Simulation	7-31
Forward Control Channel Screen	7-35
Global Action Overhead	
Message Screen	7-40
Menu	7-43
Mobile Station Control	
Message Screen	7-47
Forward Voice Channel Screen	
AMPS	7-60
NAMPS	7-63
Reverse Control Channel Screen	7-54
Reverse Voice Channel Screen	
AMPS	7-67
NAMPS	7-70
Settings	7-73

AMPS/NAMPS (cont)	
Cell Site Monitor (cont)	
Forward Control Channel Screen	7-6
Forward Control Channel Setup Menu	7-10
Forward Voice Channel Screen	
AMPS	7-19
NAMPS	7-22
Remote Operation	7-75
Reverse Control Channel Screen	7-16
Reverse Voice Channel Screen	
AMPS	7-25
NAMPS	7-28
Setup	7-1
AMPS Cellular Channel Numbers	
See <i>NADC/NAMPS Cellular Channel Numbers, Table of</i>	
Audio Signaling Format	
Generating	
Duplex Receiver	
Encoding	4-85
Selection	4-85
Examples	
5/6 Audio Coding	4-25
Audio Two Tone Coding	4-24
RF Generator	
Encoding	4-7
Selection	4-9
Receiving	
Duplex Transmitter	
Decoding	4-73
Selection	4-73
Examples	
Decoding Audio CCIR Signals	4-48
Decoding Audio User Defined Coded Signals	4-49
Receiver	
Decoding	4-37
Selection	4-35
Auxiliary Functions Menu	3-219

## B

Bit Error Rate (BER) Meter	
Menu	3-194, 3-196
Operation	4-136
Operation Screen	3-190
Specifications	1-16

**C**

Cable Fault Operation	4-112
Calendar Setup Menu	3-221
Cellular AMPS/NAMPS	7-1
Cellular Channel Formats	
E-TACS	
Duplex Receiver	4-94
Duplex Transmitter	4-78
Receiver	4-42
RF Generator	4-17
Spectrum Analyzer	4-111
NADC (AMPS, NT400®, Hyperband)	
Duplex Receiver	4-94
Duplex Transmitter	4-78
Receiver	4-42
RF Generator	4-17
Spectrum Analyzer	4-111
NAMPS	
Duplex Receiver	4-94
Duplex Transmitter	4-78
Receiver	4-42
RF Generator	4-17
Spectrum Analyzer	4-111
Clock Setup Menu	3-221
Color Selection Menu	3-222
Commands, Remote Operation	
AMPS/NAMPS Cell Site Monitor	7-75
Mandatory IEEE 488.2	6-8
Specific, IFR-1900	6-9
Configuration Report	3-220

**D**

DCS	
Generating	
Duplex Receiver	
Encoding	4-85
Selection	4-89
Example, Generating DCS Code	4-26
RF Generator	
Encoding	4-7
Selection	4-12
Receiving	
Duplex Transmitter	
Decoding	4-74
Selection	4-74
Example, Decoding DCS Signal	4-51
Receiver	
Decoding	4-36
Selection	4-36
DCS INV (Inverted)	
Generating	
Duplex Receiver	
Encoding	4-84
Selection	4-89
RF Generator	
Encoding	4-7
Selection	4-12

**D (cont)**

DCS INV (Inverted) (cont)	
Receiving	
Duplex Transmitter	
Decoding	4-74
Selection	4-74
Receiver	
Decoding	4-36
Selection	4-36
Deviation Meter (Peak)	
Menu	3-172
Operation	4-126
Operation Screen	3-169
Specifications	1-11
Deviation Meter (RMS)	
Menu	3-213
Operation	4-147
Operation Screen	3-210
Digital Multimeter (DMM)	
Menu	3-203
Operation	4-142
Operation Screen	3-200
Specification	1-14
Digital Signaling Format	
Generating	
Duplex Receiver	
Encoding	4-84
Selection	4-89
Examples	
Generating DCS Code	4-26
Generating POCSAG Code	4-27
RF Generator	
Encoding	4-7
Selection	4-12
Receiving	
Duplex Transmitter	
Decoding	4-74
Selection	4-74
Examples	
Decoding DCS Signals	4-51
Decoding POCSAG Signals	4-52
Receiver	
Decoding	4-37
Selection	4-35
Distortion Meter	
Menu	3-181
Operation	4-130
Operation Screen	3-178
Specifications	1-12
DTMF	
Generating	
Duplex Receiver	
Encoding	4-84
Selection	4-85
Example, Generating DTMF	4-23
RF Generator	
Encoding	4-7
Selection	4-8

## D (cont)

DTMF (cont)	
Receiving	
Duplex Transmitter	
Decoding	4-74
Selection	4-73
Example, Decoding DTMF	4-47
Receiver	
Decoding	4-36
Selection	4-35
Duplex	
Examples	
Measuring Linear Amplifier Gain, Compression and Bandwidth	4-68
Measuring Mixer Performance	4-69
Operation	4-55
Operation Screen	3-67
Receiver (Duplex)	
Menu	3-107
Operation	4-82
Operation Screen	3-96
Oscilloscope Display	4-92
Soft Function Keys	3-102
Spectrum Analyzer Display	4-92
Specifications	1-7
Transmitter (Duplex)	
AGC Parameters, User Defined	3-62
Decoding	4-73
Find Function	4-78
Menu	3-86
Modulation Type Parameters	3-43
Operation	4-71
Operation Screen	3-73
Oscilloscope Display	4-76
Soft Function Keys	3-77
Spectrum Analyzer Display	4-76

## E

E-TACS Cellular Channel Numbers, Table of	C-1
---	-----

## F

Find Function	
Receiver	4-41
Spectrum Analyzer	4-112
Flash Memory	
Error Messages	6-59
File Directory Operation	6-56
Frequency Error Meter	
Menu	3-162
Operation	4-121
Operation Screen	3-159
Specifications	1-11

## F (cont)

Frequency List	
Duplex Receiver	3-108
Duplex Transmitter	3-88
Receiver	3-57
RF Generator	3-26
Frequency Scan	
AF Generator	4-102
Duplex Operation	4-67
Duplex Receiver	4-95
Duplex Transmitter	4-79
Receiver	4-42
RF Generator	4-18

## G

GPiB Menu, Configure	
Menu	3-224
Operation	6-5
GPiB, Remote Operation using	6-5

## H

Hyperband Cellular Channel Numbers	
See <i>NADC/NAMPS Cellular Channel Numbers, Table of</i>	

## I

IMTS Signaling Format	
Duplex Receiver	
Encoding	4-84
Selection	4-85
RF Generator	
Encoding	4-7
Selection	4-13
I/O Connectors	
GPiB Pin-Out Table	A-5
MIC/ACC Pin-Out Table	A-3
Printer Pin-Out Table	A-8
RS-232 (HOST) Pin-Out Table	A-6
SCSI Pin-Out Table	A-4
Specifications	1-17
Table of	A-1
Video Pin-Out Table, External	A-7
Installation	2-1

## L

List, Frequency	
Duplex Receiver	3-108
Duplex Transmitter	3-88
Receiver	3-57
RF Generator	3-26

**M**

Memory Operation, Parameter Meter	4-1
Operation	4-119
Operation Screens and Menus	3-153
Modem, Remote Operation using	6-3
Modulation Meter (AM)	
Menu	3-177
Operation	4-128
Operation Screen	3-174
Specifications	1-12
Modulation Type Parameters, Table of Receiver	3-43
MTS Signaling Format	
Duplex Receiver	
Encoding	4-84
Selection	4-85
RF Generator	
Encoding	4-7
Selection	4-13
Multimeter, Digital (DMM)	
Menu	3-203
Operation	4-142
Operation Screen	3-200
Specifications	1-14

**N**

NADC-HY or -U4 or -U8	
<i>See NADC/NAMPS Cellular Channel Numbers, Table of</i>	
NADC/NAMPS Cellular Channel Numbers, Table of	B-1
NAMPS/AMPS	
<i>See AMPS/NAMPS</i>	
NT400© Cellular Channel Numbers	
<i>See NADC/NAMPS Cellular Channel Numbers, Table of</i>	

**O**

Operation Mode	
Channel	
Duplex Operation	4-66
Duplex Receiver	4-94
Duplex Transmitter	4-78
Receiver	4-42
RF Generator	4-17
Spectrum Analyzer	4-111
Direct	
Duplex Operation	4-66
Duplex Receiver	4-94
Duplex Transmitter	4-79
Receiver	4-42
RF Generator	4-17
Spectrum Analyzer	4-111
Frequency List	
Duplex Operation	4-67
Duplex Receiver	4-95
Duplex Transmitter	4-80
Receiver	4-43
RF Generator	4-19

**O (cont)**

Operation Mode (cont)	
Frequency List Scan	
Duplex Operation	4-67
Duplex Receiver	4-96
Duplex Transmitter	4-80
Receiver	4-44
RF Generator	4-19
Frequency Scan	
Duplex Operation	4-67
Duplex Receiver	4-95
Duplex Transmitter	4-79
Receiver	4-42
RF Generator	4-18
Oscilloscope	
Duplex Receiver, displayed with	4-92
Duplex Transmitter, displayed with	4-76
Marker Operation	4-107
Menu	3-137
Operation	4-105
Operation Screen	3-131
Plotting display	4-107
Receiver, displayed with	4-38
RF Generator, displayed with	4-15
Soft Function Keys	3-134
Specifications	1-15

**P**

Packing for Shipping	E-1
PCS Cellular Channel Numbers	
<i>See NADC/NAMPS Cellular Channel Numbers, Table of</i>	
Performance Evaluation	5-1
Phase Meter (PM)	
Menu	3-209
Operation	4-145
Operation Screen	3-206
Specifications	1-12
Phase Meter (RMS)	
Menu	3-217
Operation	4-149
Operation Screen	3-214
POCSAG	
Generating	
Duplex Receiver	
Encoding	4-84
Selection	4-89
Example, Generating POCSAG Code	4-27
RF Generator	
Encoding	4-7
Selection	4-12
Receiving	
Duplex Transmitter	
Decoding	4-75
Selection	4-73
Example, Decoding POCSAG Signal	4-52
Receiver	
Decoding	4-37
Selection	4-35



**P (cont)**

Power Meter (RF)	
Menu	3-167
Operation	4-123
Operation Screen	3-163
Specifications	1-10
Power Requirements	1-18, 2-1
Power Up Procedure	2-1
Printer Support Menu	3-225
Printing Display Screens	4-4

**R**

RCC Signaling Format	
Duplex Receiver	
Encoding	4-84
Selection	4-90
Examples	
Generating 2805 Code	4-28
Generating Tone Remote Code	4-29
RF Generator	
Encoding	4-7
Selection	4-13
Recalling Parameters	
Operation Screens	4-2
System (Global)	4-4
Receiver	
AGC Parameters, User Defined	3-62
Channel Format, Cellular	4-42
Decoding	
Extend Screen	3-52
Operation	4-36
Examples	
Decoding Audio CCIR Signals	4-48
Decoding Audio User Defined	4-49
Decoding DCS Coded Signals	4-51
Decoding DTMF Coded Signals	4-47
Decoding POCSAG Signals	4-52
Measuring AM or FM Transmitter Distortion	4-53
Receiving AM Signals	4-46
Receiving FM Signals	4-45
Find Function	4-41
Frequency Scan	
Menu	3-60
Operation	4-42
Menu	3-55
Modulation Types Parameters, Table of	3-43
Operation	4-33
Operation Screen	3-41
Oscilloscope display	4-38
RF Lock Operation	4-43
Signaling Formats	
Audio	4-35
Digital	4-36
DTMF	4-35
Soft Function Keys	3-45
Specifications	1-10
Spectrum Analyzer display	4-38

**R (cont)**

Remote Operation	6-1
Command Syntax	6-7
Flash Memory	
Error Messages	6-59
File Directory Operation	6-56
Mandatory IEEE 488.2 Commands	6-8
Operating Procedures	6-1
Specific Commands, IFR-1900	6-9
TMAC	6-6
Using Host System (RS-232)	6-2
Using Modem (RS-232)	6-3
Using IFR-1900 as RS-232 Terminal	6-4
Using GPIB	6-5
Repacking for Shipping	E-1
RF Frequency Error Meter	
Menu	3-162
Operation	4-121
Operation Screen	3-159
Specifications	1-11
RF Generator	
Channel Format, Cellular	4-17
Examples	
Externally Modulating RF Signal Generator	4-22
Generating 2805 Code	4-28
Generating 5/6 Audio Tone	4-25
Generating AM Modulated Signal	4-21
Generating Audio Two Tone Coding	4-24
Generating DCS Code	4-26
Generating DTMF Coded Signal	4-23
Generating FM Modulated Signal	4-21
Generating POCSAG Code	4-27
Generating Tone Remote Code	4-29
Measuring Receiver IF Bandwidth	4-32
Measuring SINAD Sensitivity, Center Frequency and Modulation Acceptance Bandwidth	4-30
Frequency Scan	
Menu	3-29
Operation	4-18
Menu	3-25
Operation	4-5
Operation Screen	3-15
Oscilloscope Display	4-15
RF Lock Operation	4-18
Signaling Formats	
Encoding	4-7
Selection	
Audio	4-9
Digital	
DCS	4-12
DCS INV (inverted)	4-12
POCSAG	4-12
DTMF	4-8
RCC	
2805	4-14
IMTS	4-14
MTS	4-14
Tone Remote	4-14
Soft Function Keys	3-21
Specifications	1-5
Spectrum Analyzer display	4-15

## R (cont)

RF Lock	
Receiver	4-43
RF Generator	4-18
Spectrum Analyzer	4-113
RF Power Meter	
Menu	3-167
Operation	4-123
Operation Screen	3-163
Specifications	1-10
RS-232 Menu, Configuration	
Menu	3-223
Operation	6-2
RS-232 Terminal, Operating IFR-1900 as	6-4

## S

Scanning	
AF Generator	4-102
Duplex Receiver	4-95
Duplex Transmitter	4-79
Receiver	4-42
RF Generator	4-18
SCSI Menu, Configure	3-224
Shipping, Repacking for	E-1
Signal Generator, AF	
Examples	
Generating AF Tone	4-104
Generating Tone Remote Code	4-104
Frequency Scan	4-102
Menu	3-126
Operation	4-99
Operation Screen and Soft Function Keys	3-123
Specifications	1-9
Signal Strength Meter	
Menu	3-189
Operation	4-134
Operation Screen	3-188
SINAD Meter	
Menu	3-186
Operation	4-132
Operation Screen	3-183
Specifications	1-13

## S (cont)

Specifications	1-5
Spectrum Analyzer	
Cable Fault	4-112
Channel Format, Cellular	4-111
Duplex Receiver, displayed with	4-92
Duplex Transmitter, displayed with	4-76
Examples	
Measuring Diplexer TX Loss and RX Isolation	4-116
Measuring Transmitter Harmonics	4-115
Measuring Very Low Power Transmitter Output	4-114
Find function	4-112
Marker Operation	4-111
Menu	3-148
Operation	4-109
Operation Screen	3-141
Plotting Display	4-113
Receiver, displayed with	4-38
RF Generator, displayed with	4-15
Soft Function Keys	3-144
Specifications	1-15
Tracking Generator Operation	4-110
Storing Parameters	
Operation Screens	4-1
System (Global)	4-3
Syntax, TMAC Command	6-7

## T

TMAC (Test Macro Language)	6-6
Command Syntax	6-7
Tone Remote Encoding	
AF Generator	4-103
Duplex Receiver	
Encoding	4-84
Selection	4-91
Example, Generating Tone Remote Code	4-104
RF Generator	
Encoding	4-7
Selection	4-14
Tracking Generator Operation	4-110